

SOKKIA

GRX5

Integrated GNSS Receiver

User Manual



GRX5
Integrated GNSS Receiver
User Manual

Part Number 1071973-01

Revision B

© 2025, Topcon Corporation

Table of Contents

Preface	v
Introduction	1-1
Overview	1-1
Key Features	1-2
Receiver Kit Contents	1-3
Cables	1-4
Accessories	1-5
Technical Support	1-6
Getting Acquainted	2-1
Receiver Overview	2-1
Main Components	2-1
Lower Housing	2-4
Battery	2-5
Battery Charging	2-5
Insufficient Power	2-8
Approximate Hours of Operation	2-8
Display Panel	2-9
Power Button	2-10
LED Display Overview	2-11
Satellite LED	2-11
Radio LED	2-11
Bluetooth LED	2-12
Recording LED	2-12
Battery LED	2-13
USB Type-C Connector	2-14
Register the GRX5 GNSS Receiver	2-14
Connection to a Computer	2-16
Connection to a Computer Through USB	2-16
GRX5Connection to a Computer Through Wi-Fi	2-16
Receiver Configuration	2-17
Receiver Configuration through a Web Interface	2-17
Option Authorization Files	2-18
Load an OAF	2-18
Receiver OAF Verification	2-20
Cellular Modem Configuration	2-20

Integrated Radio Configuration	2-21
Modem Configuration File Creation	2-22
Modem Configuration File Loading	2-24
Memory	2-25
Data Recording	2-25
Data Recording with the Power Button	2-25
Data Recording with the Web UI	2-26
Raw Data Transfer	2-27
File Deletion	2-28
Default Setting	2-28
Parameter Reset	2-28
Firmware Update	2-29
Download and Update Firmware	2-29
Operation	3-1
Field Setup	3-1
Receiver as Base Station Setup	3-2
Base Station Transmission Methods	3-5
Receiver as Rover Setup	3-7
Rover Operation Guidelines	3-8
RTK Rover Setups to Receive Corrections	3-9
General Rover Setup	3-9
Integrated Radio Modem	3-10
Integrated Cellular Modem	3-10
Dynamic TILT Compensation	3-11
Dynamic TILT Setup	3-12
TILT Compensation Operation	3-14
Other TILT States	3-16
TILT Electronic Level Operation	3-16
Electronic Level Setup	3-17
Factory Reset	3-18
Cleaning and Storing the Receiver	3-18
Specifications	4-1
GRX5 GNSS Receiver	4-1
GNSS Receiver	4-1
Positioning	4-1
Communications	4-2
I/O Port	4-2
Data Storage	4-2

Physical	4-3
Environmental	4-3
Electrical	4-3
Radio Modules.	4-5
Troubleshooting	5-1
Do This First.	5-1
Power Problems	5-1
The Receiver Power Does Not Go On	5-1
Receiver Problems	5-2
The Receiver Does Not Respond	5-2
The Receiver Does Not Track Satellites	5-2
No Data Recorded.	5-3
No RTK Solution Obtained	5-3
Regulatory Information and Safety Warnings	6-1
General Warnings	6-1
Operation Requirement.	6-2
RF Radiation Hazard Warning	6-2
Regulatory Information	6-2
FCC Statements	6-2
ISED Canada Statements	6-3
Déclaration de conformité IC.	6-3
Product Conformity	6-4
EU Declaration of Conformity (Radio Equipment Directive 2014/53/EU)	6-4
Appendix A-System Technology	A-1
Station Marker Coordinates	A-1
USB Connections.	A-2
Glossary.	Glossary-1

Preface

Thank you for purchasing this Sokkia product. The materials available in this Manual (the “Manual”) have been prepared by Topcon Positioning Systems, Inc. (“TPS”) for owners of the covered Sokkia product (the “Product”), and are designed to assist owners with the Product. Use of the Product is subject to these terms and conditions (the “Terms and Conditions”).



NOTICE

Please read the terms and conditions carefully.

Terms and Conditions

Use

This Product is designed to be used by a professional. The user should have a good knowledge of the safe use of the Product and implement the types of safety procedures recommended by the local government protection agency for both private use and commercial job sites.

Copyrights

All information contained in this Manual is the intellectual property of, and copyrighted material of TPS. All rights are reserved. Do not use, access, copy, store, display, create derivative works of, sell, modify, publish, distribute, or allow any third party access to, any graphics, content, information or data in this Manual without TPS’s express written consent and may only use such information for the care and operation of the Product. The information and data in this Manual are a valuable asset of TPS and are developed by the expenditure of considerable work, time and money, and are the result of original selection, coordination and arrangement by TPS.

Trademarks

Sokkia[®], Sokkia[®] GNSS receiver with TILT (Topcon Integrated Leveling Technology)[™], Sokkia[®] GNSS Receiver, Fence Antenna[®] technology, Vanguard Technology[™], LongLink[™] communication, Quartz Lock Loop[™] (QLL) technology, Skybridge[™], mmGPS[®] laser augmented machine control system, Topcon Field data collection software, Topcon Office software, Topcon Tools, Sitelink[®] construction site management service, Topcon[®] and Topcon Positioning Systems[™] are trademarks or registered trademarks of TPS. Windows[®] is a registered trademark of Microsoft Corporation. The *Bluetooth*[®] word mark and logos are owned by Bluetooth SIG, Inc. and any use of such marks by Topcon Positioning Systems, Inc. is used under license. Other product and company names mentioned herein may be trademarks of their respective owners.

Disclaimer of Warranty

EXCEPT FOR ANY WARRANTIES IN AN APPENDIX OR A WARRANTY CARD ACCOMPANYING THE PRODUCT, THIS MANUAL AND THE PRODUCT ARE PROVIDED “AS-IS.” THERE ARE NO OTHER WARRANTIES. TPS DISCLAIMS ANY IMPLIED WARRANTY OF MERCHANTABILITY OR FITNESS FOR ANY PARTICULAR USE OR PURPOSE.

Limitation of Liability

TPS AND ITS DISTRIBUTORS SHALL NOT BE LIABLE FOR TECHNICAL OR EDITORIAL ERRORS OR OMISSIONS CONTAINED HEREIN; NOR FOR INCIDENTAL OR CONSEQUENTIAL DAMAGES RESULTING FROM THE FURNISHING, PERFORMANCE OR USE OF THIS MATERIAL OR THE

PRODUCT. SUCH DISCLAIMED INCIDENTAL OR CONSEQUENTIAL DAMAGES INCLUDE BUT ARE NOT LIMITED TO LOSS OF TIME, LOSS OR DESTRUCTION OF DATA, DAMAGE TO OR LOSS OF LIVESTOCK AND/OR CROPS, LOSS OF PROFIT, SAVINGS OR REVENUE, OR LOSS USE OF THE PRODUCT.

IN ADDITION, TPS IS NOT RESPONSIBLE OR LIABLE FOR DAMAGES OR COSTS INCURRED IN CONNECTION WITH OBTAINING SUBSTITUTE PRODUCTS OR SOFTWARE, CLAIMS BY OTHERS, INCONVENIENCE, OR ANY OTHER COSTS. IN ALL CASES, TPS SHALL HAVE NO LIABILITY FOR DAMAGES OR OTHERWISE TO YOU OR ANY OTHER PERSON OR ENTITY IN EXCESS OF THE PURCHASE PRICE PAID FOR THE PRODUCT.

License Agreement

Use of any computer programs or software supplied by TPS or downloaded from a TPS website (the “Software”) in connection with the receiver constitutes acceptance of these Terms and Conditions in this Manual and an agreement to abide by these Terms and Conditions. The user is granted a personal, non-exclusive, non-transferable license to use such Software under the terms stated herein and in any case only with a single receiver or single computer. You may not assign or transfer the Software or this license without the express written consent of TPS. This license is effective until terminated. You may terminate the license at any time by destroying the Software and Manual. TPS may terminate the license if you fail to comply with any of the Terms or Conditions. You agree to destroy the Software and manual upon termination of the use of the receiver. All ownership, copyright and other intellectual property rights in and to the Software belong to TPS. If these license terms are not acceptable, return any unused software and manual.

Website; Other Statements

No statement contained at the TPS website (or any other website) or in any other advertisements or TPS literature or made by an employee or independent contractor of TPS modifies these Terms and Conditions (including the Software license, warranty and limitation of liability).

Technical Documentation and Utility Software

Download and open the myTopcon NOW! app on your iOS or Android device or visit the Topcon support website (mytopconnow.topconpositioning.com). Log in to access available manuals, technical and compliance documentation, training material, and utility software to help set up and use your Sokkia product.

Safety

Improper use of the Product can lead to injury to persons or property and/or malfunction of the Product. The Product should only be repaired by authorized TPS warranty service centers.

Miscellaneous

The above Terms and Conditions may be amended, modified, superseded, or canceled, at any time by TPS. The above Terms and Conditions will be governed by, and construed in accordance with, the laws of the State of California, without reference to conflict of laws.

Open Source Support

The Topcon Open Source Software website contains the licenses and notices for open source software used in this product.

With respect to the free/open source software, if you have any questions or wish to receive a copy of the source code to which you are entitled under the applicable free/open source license(s), such as the GNU Lesser/General Public License, please visit oss.topconpositioning.com/.

Manual Conventions

This manual uses the following conventions:

Convention	Description	Example
Bold	Menu, or drop-down list selection	File > Exit (Select the File menu and click Exit)
	Name of a dialog or screen	From the Connection screen...
	Button or key commands	Select Finish .
<i>Italic</i>	Reference to another manual or help document	Refer to the <i>Sokkia Reference Manual</i> .



TIP

Notification that one or more steps may be taken to reduce effort, time, and/or expense.



NOTE

Further information to note about system configuration, maintenance, or setup.



NOTICE

Supplementary information that if disregarded can have an adverse effect on system operation, system performance, data integrity, or measurements.



CAUTION

Notification that an action has the potential to result in minor personal injury, system damage, loss of data, or loss of warranty.



WARNING

Notification that an action has the potential to result in personal injury or property damage.



DANGER

Notification that an action has the potential to result in severe personal injury or death.

Introduction

If this is the first operation of the GRX5, obey the instructions to complete the initial setup of the receiver.

Overview

The Sokkia GRX5 GNSS integrated receiver is a compact, light-weight, and resistant GNSS receiver.

The GRX5 has these components in a resistant magnesium housing:

- GNSS antenna
- GNSS receiver module
- Inertial Measurement Unit (IMU)
- Wi-Fi, and Bluetooth wireless technology
- integrated 4G cellular modem
- lithium-ion batteries
- optional radio modem.

You can use the receiver as a real-time kinematic (RTK) base station and/or rover to transmit and receive GNSS corrections to calculate RTK solutions. Control of the receiver is easy when paired with Topcon field application software, for example, Topcon Field or Pocket 3D.

The GNSS data can be saved in the GRX5 memory for static and kinematic post-processing functions. The data can be imported into Topcon Tools or other post-processing software, and paired with more GNSS data to calculate accurate survey data.

The GRX5 gives high precision and robust performance that is ideal for the surveying, civil engineering, construction, forestry, mining, oil and gas, landfill, and agricultural industries.



Figure 1-1: GRX5 GNSS Receiver

Key Features

- All-in-view satellite tracking: multi-constellation, multi-frequency.
- 448 hardware channels for simultaneous tracking of all visible supported satellite signals:
 - GPS: L1C/A, L1P, L2P, L2C, L5
 - GLONASS: L1C/A, L2P, L2CA, L3
 - GALILEO: E1, E5A, E5B, E5 AltBOC, E6
 - BEIDOU: B1, B1C, B2, B2a, B2b, B3
 - QZSS: L1C/A, L1 CB, L2C, L5
 - NavIC: L5
 - SBAS: L1, L5
- GNSS anti-jamming, anti-spoofing interference monitoring & mitigation technology for improved signal integrity.
- Enhanced Topcon Integrated Leveling Technology (TILT) with calibration-free and magnetically immune IMU-based tilt compensation technology for RTK measurements.
- 20 GB internal memory.

- USB Type C connection for communications and power.
- Internal, non-removeable, lithium-ion batteries for 10+ hours of GNSS rover operation.
- Bluetooth and Bluetooth Low Energy (BLE) wireless technology for cable free operation.
- Multi-channel LongLink Bluetooth technology for license free RTK communication.
- Minimum Interface (MINTER) consisting of a power button and LEDs for control and display of the receiver's operation.
- Integrated 4G cellular modem for obtaining network GNSS corrections.
- Built-in Wi-Fi with access point and client support.
- On-board Web interface that allows configuring the receiver for a wide variety of functions.
- Optional 1W transmit / receive radio modem configurations:
 - SATEL TR4+ UHF radio (403 MHz to 473 MHz)
 - Alinco UHF radio (351.20000 MHz to 351.38125 MHz available in Japan)

Receiver Kit Contents

Make sure that none of the items in this section is missing. If an items is missing or has damage, tell a local Sokkia dealer.



NOTE

Components in the standard kits may be different by region. Speak with a local Sokkia dealer about items included in your standard kit and accessories that are available with the receiver.

Table 1-1: includes the standard GRX5 kit components. For more information about the included cables, see “Cables” on page 1-4 and “Accessories” on page 1-5.











Table 1-1:GRX5 Standard Kit Components

GRX5 GNSS Receiver	USB-C AC power supply
USB type-C cable	Power cable for AC power supply
USB type-C to USB type-A adapter	myTopcon registration card
GRX5 GNSS Receiver Quick Reference Card (P/N 1071974-01)	

Cables

The GRX5 kit includes a power supply cable, a USB-C cable and a power adapter. Table 1-2: shows the cables included with the receiver (which can be different by region), and optional cables for additional configurations. Speak to a local Sokkia dealer about the standard receiver kit items.

Table 1-2:Receiver Cables

<p>USB-C AC adapter P/N 1068616-01 Used, in conjunction with the appropriate regional power cable, to charge the internal batteries of the GRX5 receiver. Operates between 32 °F (0 °C) and 104 °F (40 °C).</p>	
<p>USB Type-C cable P/N 1068615-01 Used to connect the GRX5 receiver to a field controller or computer for data transfer and firmware updates.</p>	
<p>USB Type-C to USB Type-A adapter P/N 1068617-01 Used with the USB-C cable, enables connection to a computer with a USB type-A port</p>	
<p>Power cable, North America P/N 1005793-01 Power cable for use with the GRX5 AC power supply.</p>	
<p>Power cable, Europe P/N 1005794-01 Power cable for use with the GRX5 AC power supply.</p>	
<p>Power cable, Australia P/N 1021180-01 Power cable for use with the GRX5 AC power supply.</p>	
<p>Serial cable with seal P/N 1062146-01 Used to connect the GRX5 receiver to an external serial device, for example, an external radio.</p>	
<p>USB-C SAE power cable with seal P/N 1059087-01 Used to connect the GRX5 receiver to a DC power source via an SAE cable.</p>	
<p>SAE cable extension P/N 14-008022-01 Used to connect the GRX5 receiver to a DC power supply. The 2 m cable length facilitates keeping the power supply in a safe location.</p>	
<p>Alligator clips P/N 14-008025-01 Used to connect the GRX5 receiver to a 12 VDC power source via an SAE cable.</p>	

Accessories

Sokkia offers many accessories for system flexibility and job site efficiency. For more information about the accessories that are available for GRX5, speak with a local Sokkia dealer.



NOTE

Some of the accessories below can be in a GRX5 kit. Kits are different by region. If you have questions, speak with a local Sokkia dealer.

Table 1-3:GRX5 Accessories













GRX5 hard case P/N 1029861-02	
Whip antenna, 351 to 358 MHz P/N 1065028-01	
Whip antenna, 400 to 450 MHz P/N 1065028-02	
Whip antenna, 430 to 480 MHz P/N 1065028-03	
2 m 2 section fixed height range pole P/N 80816	
Hybrid positioning adapter P/N 1003241-01	
Wide base topographic shoe P/N 808852	
Sokkia carbon fiber prism pole bipod P/N 1009273-01	
Heavy duty tripod with bag P/N 22-050501-01	

Table 1-3:GRX5 Accessories

Heavy duty tripod with bag P/N 1030650-01	
Tribrach with optical plummet, black P/N 22-006008-01	
#5 tribrach adapter with center P/N 51842	
100 mm prism spacer P/N 51949	
GPS antenna height measuring bracket P/N 1013050-01	
<p>Field Controllers and Brackets: Sokkia sells many resistant tablets to use as field controllers of Sokkia GNSS receivers, robotic total stations, and scanners. Speak with a local Sokkia dealer for information.</p> <p>Field and Office Application Software: Sokkia sells field and office software with intuitive interfaces and advanced features that make complex or redundant tasks easy. Sokkia solutions have data management and advanced analytics to better assemble job sites, collect data, and manage projects. Available products include Topcon Field, Pocket 3D, Topcon Office, and Topcon Tools. Speak with a local Sokkia dealer for information.</p>	

Technical Support

1. See “Troubleshooting” on page 5-1 for solutions that can correct problems with the receiver before you speak with Topcon customer support.
2. Speak with a local Sokkia dealer or go to the myTopconNOW website (<https://mytopconnow.topconpositioning.com>) for technical support.



NOTICE

Give a full description of the problem to quickly get support.

3. For better technical aid from Sokkia, supply the information that follows:
 - The field operation that was done when the problem occurred
 - Specified information about the issue, symptoms, and all error messages that come before or after the problem
 - The frequency with which the problem occurred or patterns

- Receiver information and configuration:
 - 1) Set the receiver power to ON.
 - 2) Connect the receiver to a computer or field controller and open the web UI (see “Connection to a Computer” on page 2-16).
 - 3) Select **About > Information > File**.

This screen shows the basic information about the receiver, which includes:

 - Serial Number
 - Installed firmware version(s)
 - Receiver Board ID
 - Hardware version
 - 4) Select **Management > Troubleshooting > Download Log**.
 - 5) Select **Save to File**, then select a location on the computer in which to save the file.
 - 6) Send this file to the Topcon support staff.
- Specifications of the mobile devices and computers used in the field or office that have the problem, which include:
 - Model information
 - Version number
 - Operating system information
 - Memory and storage capacity
- System software information, which includes:
 - Version number
 - Steps to reproduce the problem
- Specified information about the field environment and/or observation of conditions when the problem occurred.

Getting Acquainted

This chapter contains the necessary information to know the GRX5 GNSS receiver components, their functions, and how to set up the GRX5 GNSS receiver for operation.

Receiver Overview

Main Components

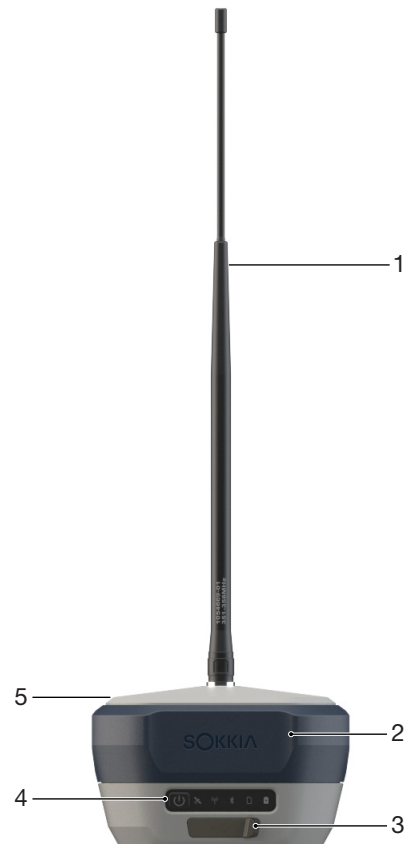

- | | | | |
|---|--|---|---------------------|
| 1 | Radio whip antenna for variants with integrated radio modems | 4 | MINTER |
| 2 | Shock absorbing bumper | 5 | GNSS antenna/radome |
| 3 | USB Type-C connector | | |

Figure 2-1: GRX5 GNSS Receiver

The GRX5 GNSS receiver includes a GNSS antenna, GNSS receiver module, many communication technologies, internal non-removable batteries, and an internal memory card in a resistant, fully sealed magnesium housing.

The upper part of the receiver, that includes the GNSS and wireless communication antennas, has a shock-absorbing rubber bumper.



Figure 2-2: GRX5 with and without Radio Antenna Connector

The GRX5 GNSS receiver is available in many hardware configurations. The primary configurations are with or without an integrated radio modem. Table 2-1: shows the available configurations, how to identify each one, and the applicable radio antennas for the specified receiver configurations and regions.



NOTE

GRX5 GNSS Receiver assemblies vary depending on country or region. Speak with a local Sokkia dealer to inquire about local availability.

Table: 2-1: GRX5 GNSS Receiver Assemblies, Part Numbers, and Descriptions

Assembly and Part Number	Description
GRX5 No Modem (4G Cellular) P/N 1049333-03	The receiver does not include an integrated radio modem, no applicable radio antenna.
GRX5 Internal UHF Radio Modem (4G Cellular) P/N 1049333-01	The receiver includes an integrated SATEL-TR4+ radio modem and external antenna connector. Supported frequency bands: <ul style="list-style-type: none"> Licensed 403 to 473 MHz Available radio antennas: <ul style="list-style-type: none"> 400 to 450 MHz whip antenna, P/N 1065028-02 430 to 480 MHz whip antenna, P/N 1065028-03
GRX5 Internal Alinco Radio Modem (4G Cellular) P/N 1049333-02	The receiver includes an integrated ALINCO XE9030EP radio modem. Supported frequency bands: <ul style="list-style-type: none"> 351.20000-351.38125 MHz (only available in Japan) Available radio antenna: <ul style="list-style-type: none"> 351 to 358 MHz whip antenna, P/N 1065028-01

For specified GRX5 GNSS receivers that contain an integrated radio modem, the radio antenna connects to the external antenna RP_SMA connector on the radome (Figure 2-3). Table 2-1: shows the four available whip antennas that are specially tuned to transmit/receive the frequencies used by the different radio modems. The whip antennas have the frequency ranges printed on them and are color-coded on the inner sides of the connectors (Figure 2-4 on page 2-3). The frequency ranges are printed on the antennas and color-coded on the inner sides of the connectors. For more specification information, see “Radio Modules” on page 4-5.



1 Antenna Connector

Figure 2-3: Antenna Connector on Radome



NOTE

The internal radio modems available in the Sokkia GRX5 GNSS receiver operate with the antennas in Figure 2-4. Antennas not shown below or on Table 2-1: cannot be used with this device.



Figure 2-4: Radio Antennas

Lower Housing

The bottom of the receiver has the regulatory information (1, Figure 2-5), part number (P/N 2, Figure 2-5), product serial number (S/N 3, Figure 2-5), and QR code labels (4, Figure 2-5).

Scan the QR code for access to myTopconNOW! for registration, user documentation, and firmware updates (see “Register the GRX5 GNSS Receiver” on page 2-14).

Use the 5/8-11 in. threaded socket for standard receiver installations on a range pole or tripod.



- | | | | | | |
|---|----------------------------|---|---------------|---|---------|
| 1 | Regulatory Label | 3 | Part Number | 5 | QR Code |
| 2 | 5/8-11 in. threaded socket | 4 | Serial Number | | |

Figure 2-5: Enclosure Underside with Product Identification and Regulatory Labels

Battery

The receiver receives power from two internal, non-removable, fast-charging, lithium-ion battery packs (Figure 2-6). Each battery pack is rated at 7.2 VDC, 3.5 Ah.



NOTE

The receiver pulls a small quantity of power from the batteries when power is set to OFF. If the receiver is in storage for 2 months or longer, the battery can become fully discharged. The battery must be fully charged before it is used.

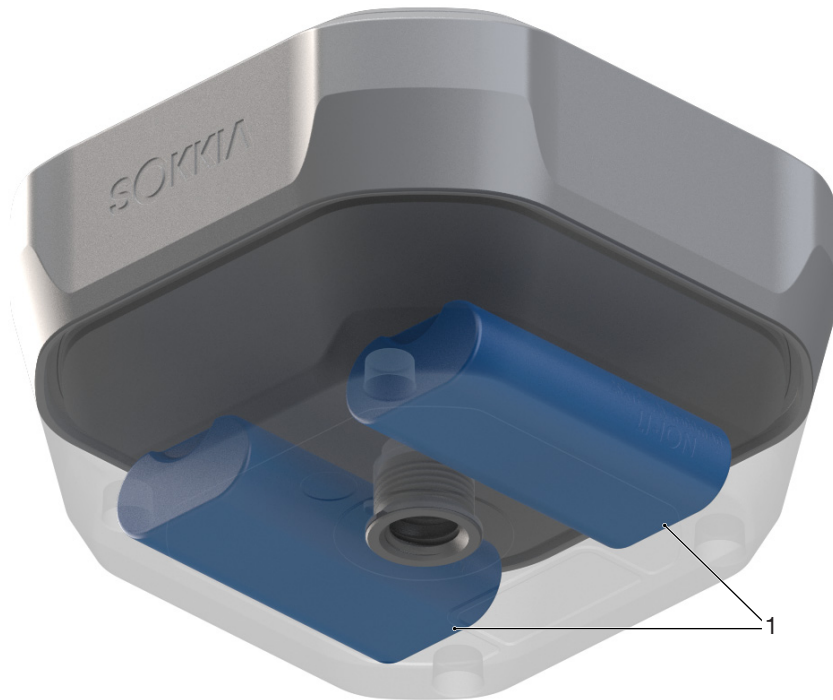

- 1 Internal battery pack (two batteries – bottom view)

Figure 2-6: GRX5 Internal Battery Pack

Battery Charging

The GRX5 GNSS receiver uses the internal battery pack for power. When an external power source is connected to the receiver, the receiver pulls power from the external source.

Battery Charging Temperatures

Table: 2-2: Battery Charging Temperatures

Only charge the battery pack in temperatures between 32 °F (0 °C) and 104 °F (40 °C).

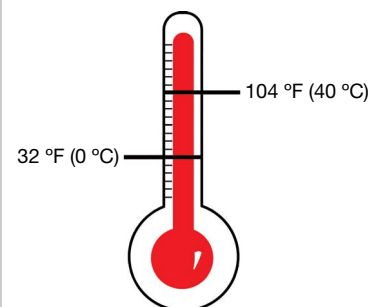

The optimal charging temperature is between 50 °F (10 °C) and 77 °F (25 °C). If possible, charge the battery pack in this temperature range.

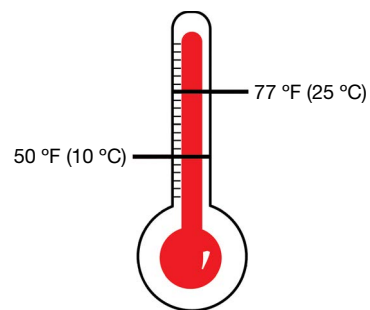

NOTICE

The charge process automatically stops if the battery temperature is above 113 °F (45 °C) or below 32 °F (0 °C).

Battery Charging with External AC Power



CAUTION

Make sure that the USB port of the receiver is free of moisture before a charge process is started.



CAUTION

You must use a grounded outlet or grounded surge protector to charge the battery pack.

To charge the internal battery pack with external AC power:

1. Connect the supplied USB Type-C cable (2, Figure 2-7) to the USB Type-C connector (1, Figure 2-7, on the receiver see “USB Type-C Connector” on page 2-14).
2. Connect the USB Type-C cable to the power supply (3, Figure 2-7)
3. Connect the power cable (4, Figure 2-7) to the connector on the power supply.
4. Connect the power cable to an available outlet for approximately two hours to fully charge the battery pack.

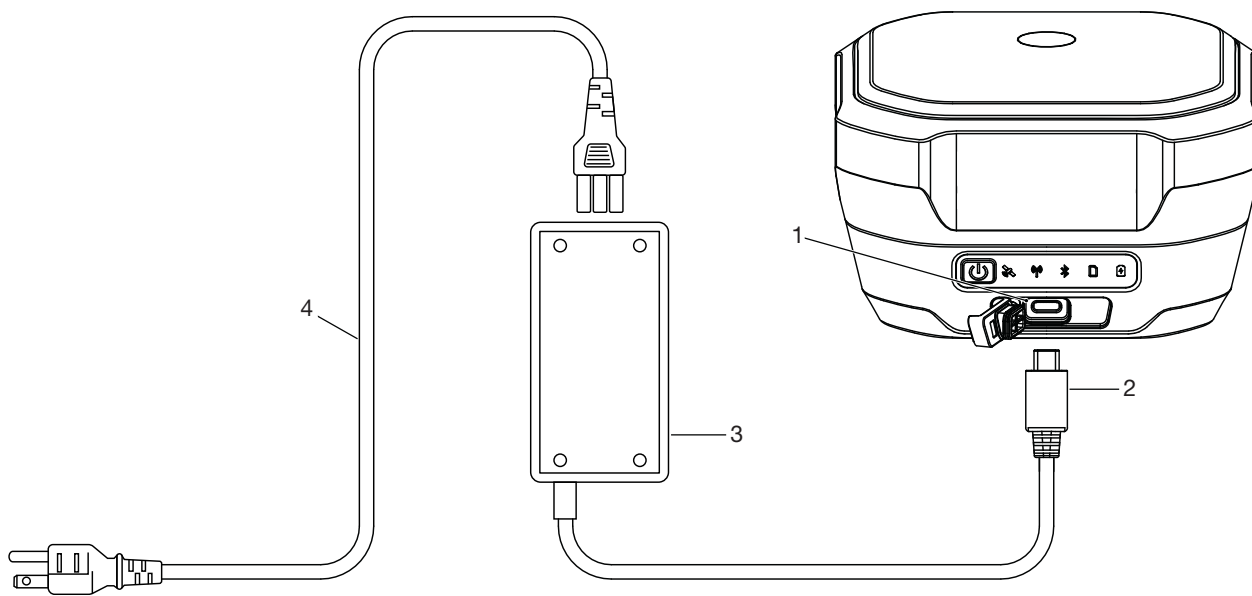

1 USB Type-C connector

2 USB Type-C cable

3 Power supply

4 Power cable

Figure 2-7: AC Power Connection

The Power button/LED on the GRX5 GNSS receiver shows when external power is applied. The Battery capacity LED flashes, to show that the battery pack charge process is in operation. The color of the LED indicates the charge level (see “Battery LED” on page 2-13).

Battery Charging with External DC Power

You can connect the GRX5 GNSS receiver to an external DC power source, for example, a vehicle battery with 8 to 16 VDC, to operate or charge the receiver with the USB Type-C to SAE accessory cable.



CAUTION

Do not use a power input of more than 27 VDC, it can cause damage to the receiver.



WARNING

When you connect an external battery the receiver, make sure to use the specified Sokkia accessory cables. These cables have over-current protection for safe operation and to prevent damage to the receiver.

To charge the internal battery pack with external DC power:

1. Connect the SAE to USB type-C cable (2, Figure 2-8) to the USB Type-C connector on the GRX5 GNSS receiver (1, Figure 2-8).
2. Connect the SAE to USB Type-C cable to the SAE to SAE extension cable (3, Figure 2-8).
3. Connect the SAE to SAE extension cable to the SAE cable with alligator clips (4, Figure 2-8).
4. Connect the alligator clips on the SAE cable with alligator clips to a charged 12 VDC battery (5, Figure 2-8).

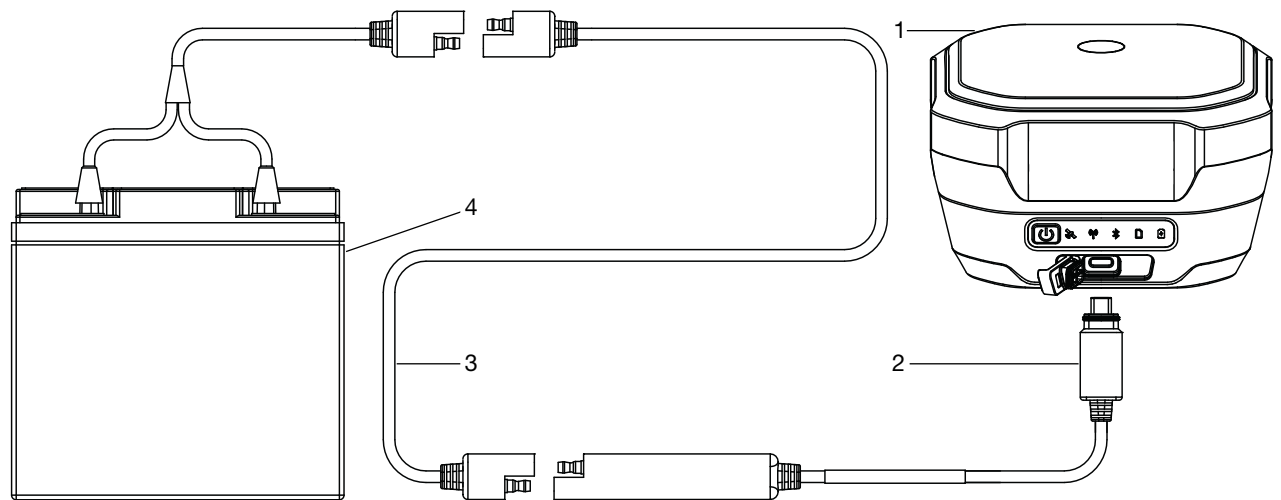

- | | | |
|--------------------------------------|----------------------------------|------------------|
| 1 Receiver with USB Type-C connector | 3 SAE to SAE extension | 5 12 VDC battery |
| 2 SAE to USB Type-C cable | 4 SAE cable with alligator clips | |

Figure 2-8: DC Power Connection

The Power button/LED on the GRX5 GNSS receiver shows when external power is applied. The Battery capacity LED flashes during the battery pack charge process. The color of the LED shows the charge level (see “Battery LED” on page 2-13).

Insufficient Power

If the battery pack becomes fully discharged and an external power supply is not connected, the GRX5 GNSS receiver automatically stops and saves recorded files. To prevent disruption, examine the battery charge level on the Battery capacity LED on the MINTER (see “Battery LED” on page 2-13). If the receiver shuts down due to insufficient power, the receiver and all communication ports stop operation.

To restore power to the receiver, make sure that the USB port on the GRX5 is free of moisture, then connect the receiver to an external power source.

Approximate Hours of Operation

Table 2-3: shows the conditions and the approximate hours of operation of the GRX5 GNSS receiver with the internal battery pack.



NOTE

Approximate hours of operation are calculated from an average with Bluetooth on and 20 Satellites monitored with a new, fully-charged battery pack, at room temperature, and a transmission rate of 1 Hz.

Table: 2-3: GRX5 Approximate Hours of Operation

Use Condition	Description	Hours of Operation
Static Survey	Static operation with GNSS data saved at 1 Hz	15 hours
LongLink RTK Base Station	RTCM3 differential correction transmission to one to three rovers	13 hours
LongLink RTK Rover	RTCM3 differential corrections through LongLink connected to a data collector through Bluetooth	13 hours
Network RTK Base Station	RTCM3 differential correction transmission by the internal cellular module	11 hours
Network RTK Rover	RTCM3 differential corrections from a Network correction service by the internal cellular module	11 hours
UHF-RTK Base Station (4FSK, RTCM SC135, 12.5 kHz, 1 W, RTCM3.2 MSM3)	RTCM3 differential corrections transmission at 0.5 W	7 hours
UHF-RTK Base Station (4FSK, RTCM SC135, 12.5 kHz, 1 W, RTCM3.2 MSM3)	RTCM3 differential corrections transmission at 1.0 W	7 hours
UHF-RTK Rover (- 4FSK, RTCM SC135, 12.5 kHz, RTCM3.2 MSM3)	RTCM3 corrections through UHF radio connected to a data collector via Bluetooth	10.5 hours

Display Panel

The GRX5 GNSS receiver has a minimum interface (MINTER) with a multifunction button that sets the receiver power ON and OFF and starts data logging (Figure 2-9). LEDs show the operation condition (Figure 2-10 on page 2-9).



1 Power button

2 LED display panel

Figure 2-9: Power Button and LED Display Panel

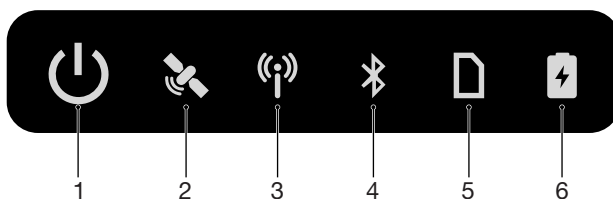

1 Power button

3 Radio modem LED

5 Recording LED

2 Satellite condition LED

4 Bluetooth LED

6 Battery capacity LED

Figure 2-10: LED Display Panel

Power Button



The GRX5 GNSS receiver power button has many functions. The length of time during which the button is pushed and held selects how the receiver operates. When the button is pushed, the LED panel shows the selected operation. Table 2-4: shows how to use the power button.

Table: 2-4: Power Button Functions

Function	Push for	Description
Set power ON	2 seconds	Push, then release when the LEDs on the display panel are solid YELLOW. The power LED flashes YELLOW until startup is completed. The power LED is solid GREEN if an external power source is connected to the receiver. If an external power source is not connected, the power LED is OFF.
Set power OFF	3 to 10 seconds	Push and hold for more than 3 seconds but not more than 10 seconds. Release when the LEDs on the display panel are solid WHITE.
Start/Stop data logging	Push and release three consecutive times within 2 seconds	See “Recording LED” on page 2-12
Reset parameters	10 to 15 seconds	Release when the satellite condition LED is MAGENTA.
Factory Reset	30 to 35 seconds	Release when the LEDs on the display panel are solid RED.
Emergency shutdown with no external power source connected	Longer than 60 seconds	Release when all LEDs are OFF.
Update firmware		Flashes GREEN, then YELLOW during installation (see “Firmware Update” on page 2-29).



NOTE

There can be an interval of some seconds after the Power button is released and the first/last time that the recording LED flashes.





NOTE

With external power engaged, the Power LED is solid GREEN unless startup or shutdown is in operation.

LED Display Overview

The LEDs on the MINTER have colors that show the satellite tracking condition, radio modem condition, Bluetooth condition, and battery capacity levels. There are five LEDs that give information about satellite tracking, data recording, Bluetooth, radio, and internal battery life. This section gives information about the color and condition of each LED.

Table 2-1:LED Icon States





Display		
		
State		
Solid	Flashes	OFF

Satellite LED



The satellite LED shows the condition of tracked satellites when the receiver power is ON.

Table 2-2:Satellite Tracking LED States

Display	LED Color	Description
	Flashes RED	No satellite tracking
	Solid RED	Satellite tracking in progress, position unavailable
	Solid YELLOW	Satellite tracking in progress and receiver has position, but no fixed solution
	Solid GREEN	Receiver has fixed solution
	Flashes RED, GREEN, YELLOW	Option Authorization File (OAF) is invalid or expired.



Radio LED



The Radio LED shows the condition and operation mode of the integrated radio modem (only applies to receiver models that have an integrated radio modem).

Table 2-3:UHF Radio Modem LED States

Display	LED Color	Description
	Solid GREEN	Radio modem is ON and prepared for operation



Display	LED Color	Description
	Solid GREEN/Flashes YELLOW	Modem receives corrections from a base station
	Solid GREEN/Flashes RED	Modem transmits corrections

Bluetooth LED



The Bluetooth LED shows the condition of the Bluetooth activity.

Table 2-4:Bluetooth LED States

Display	LED Color	Description
	Flashes BLUE	Bluetooth is ON and can be found
	Solid BLUE	One Bluetooth connection is made
	Solid BLUE + Flashes BLUE *N every 10 seconds	Many (N) valid Bluetooth connections made

Recording LED



The recording LED shows if memory storage is used and shows the current survey mode (static or kinematic) when the **Occupation mode** switch is selected.

Table 2-5:Recording LED States









Display	LED Color	Description
	Flashes GREEN	Data logging in progress, memory capacity $\geq 10\%$
	Flashes YELLOW	Data logging in progress, memory capacity less than 10% but more than 1%
	Flashes RED	Data logging in progress, memory capacity $< 1\%$
	Solid RED	Memory capacity is full
	Flashes BLUE	File deletion in progress
	Flashes MAGENTA (2 per second)	Internal memory card format in progress
	Flashes MAGENTA (1 per second)	File system check in progress

Table 2-5:Recording LED States







Display	LED Color	Description
	Flashes MAGENTA (1 flash per 2 seconds)	File system mount in progress

Battery LED



The battery LED shows the charge capacity of the internal battery pack. When an external power source is connected, the LED turns solid green and flashes while the internal battery pack charges.

Table 2-6:Battery LED States

Display	LED Color	Description
	Solid GREEN	Battery capacity \geq 50%
	Solid YELLOW	Battery capacity between 50% and 15%
	Solid RED	Battery capacity \leq 15%
	Flashes GREEN	External power connected and in operation/battery charge in progress, battery capacity \geq 50%
	Flashes YELLOW	External power connected and in operation/battery charge in progress, battery capacity between 50% and 15%
	Flashes RED	External power connected and in operation/battery charge in progress, battery capacity \leq 15%



NOTE

When the internal battery capacity of the GRX5 is 5%, power to the receiver automatically goes OFF. This keeps the internal battery pack capacity from above zero and lets the receiver do a safe shutdown. This saves recorded data and the receiver configuration. Power to the receiver does not come back ON until the battery capacity is above 5%.

USB Type-C Connector

The GRX5 GNSS receiver has a USB Type-C connector on the front side of the lower housing below the MINTER (Figure 2-11). The connector has a protective cover.

Use the USB Type-C connector to:

- Supply power from an external source
- Charge the battery
- Connect a field controller, computer, or external memory to the receiver.



Figure 2-11: USB Type-C Connector

Register the GRX5 GNSS Receiver

Register your GRX5 GNSS receiver for maximum support and access to:

- Newest firmware/software updates
- Quick Reference Guides
- Manuals
- Training videos
- Warranty registration.

To register your Sokkia GRX5 GNSS receiver, scan the QR code on the myTopcon NOW! Registration card included with the receiver. This opens the myTopcon NOW! mobile app that gives you access to support content in the field with a smart device.



Register your Topcon products using the **myTopcon NOW!** mobile app.



SCAN THE QR CODE ABOVE OR REGISTER AT myTopconNOW.topconpositioning.com



Figure 2-12: Registration Card

You can also go to <https://mytopcon.topconpositioning.com/register/> with a computer browser.

1. Start an account or log on to a current account.

Sign up is free.

2. Select **REGISTER HARDWARE**.
3. Enter the serial number of the receiver.

REGISTER HARDWARE: **Step 1 of 2:** Enter your product serial number.

How do I find my serial number?

Enter Serial Number

CONTINUE

Figure 2-13: Registration Enter Serial Number

4. Add/accept the specified information.

REGISTER HARDWARE: **Step 2 of 2:** Add/Confirm your product details.

Product Category
GNSS Solutions: GNSS Receivers

Product
GRX5

Serial Number
XXXX-12345

[Incorrect serial number?](#)

Purchase Date

Asset Information (Optional) [What's this?](#)

Asset Name

Asset Number

CANCEL REGISTER PRODUCT

Figure 2-14: Registration Product Details

Connection to a Computer

Connection to a Computer Through USB

The GRX5 GNSS receiver can connect to a computer with a USB Type-C cable (P/N: 1068615-01) from the USB Type-C port on the receiver to a USB Type-C port on a computer (Figure 2-15). If the computer does not have an available USB Type-C port, use the USB-C to USB-A adapter (P/N: 1068617-01) to connect to a USB Type-A port on the computer.

Make sure that the battery pack in the receiver is fully charged, then connect to a computer.

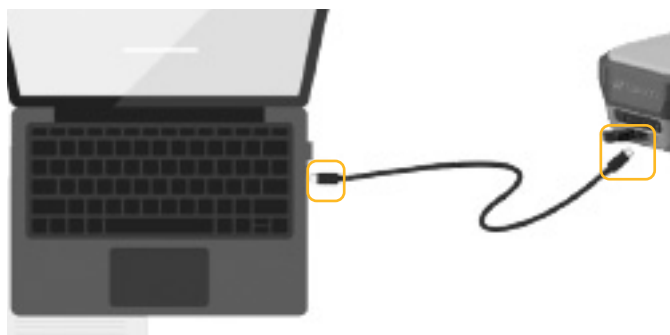

Figure 2-15: Receiver to Computer Connection

1. With the GRX5 and computer connected with the USB Type-C cable, push and hold the Power button on the GRX5 GNSS receiver for 2 seconds to set the power to ON.
2. Open a web browser, then enter the receiver IP address in the URL field.

By default, the IP address of the receiver is `http://192.168.4.1`. The first time that the web interface opens, it is necessary to enter a user name and password.

3. Enter the login user name and password at the prompt.

The default login user name is ***admin*** and the default password is ***admin***.

GRX5 Connection to a Computer Through Wi-Fi

The GRX5 GNSS receiver has an internal Wi-Fi module that lets it connect to a field controller, computer, or smart device (access point mode), or to a wireless network (client mode). You can use Wi-Fi to connect to the receiver to get access to the internal memory, configure, and update the receiver firmware. A cable connection to the receiver is not necessary.

To connect to the receiver through Wi-Fi:

1. Find the wireless network connection access point SSID for the receiver with the Wi-Fi network connection application on your PC, field controller, or smart device.

The label is `GRX5-AP-XXXX-XXXXXX`, where `XXXX-XXXXXX` is the serial number of the receiver.

2. Select this Wi-Fi access point SSID, then select **Connect**.
3. Enter the default Wi-Fi access point password, which is the serial number of the receiver.

4. Open a web browser, then enter ***http://192.168.4.1/*** in the URL field.
5. Enter the default login user name and password:
 - User name: ***admin***
 - Password: ***admin***

**NOTE**

You can select **Settings > Network > Wi-Fi** to change the Wi-Fi access point password. After the password is changed, it is necessary to select **Apply** and do a power cycle of the receiver.

**NOTE**

If the password is lost, reset the receiver to factory defaults (see “Factory Reset” on page 3-18).

After a successful login, the web UI shows a dashboard with general information about the receiver in real-time. Settings configuration is enabled.

Receiver Configuration

Receiver Configuration through a Web Interface

The GRX5 GNSS receiver has an on-board web user interface (UI) that can work with field controllers, computers, tablets, and/or smart devices with Wi-Fi network functions.

After a connection between the receiver and the device is made with a web browser, enter the IP address of the receiver (default IP address is: `http://192.168.4.1`.) and log on. Access to the on-board web UI becomes available.

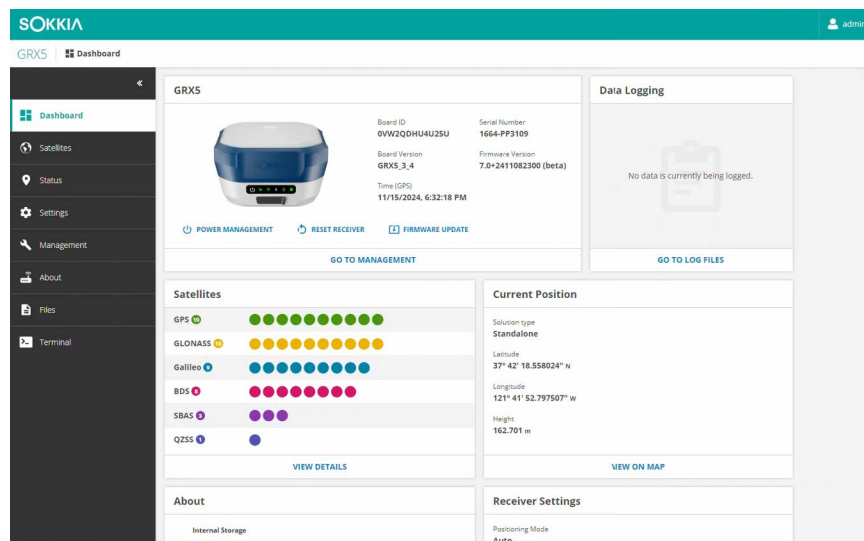

Figure 2-16: Web UI Dashboard

Use the web UI to configure the receiver settings. The menus that follow are available for receiver configuration:

- **Dashboard** – the primary console with an overview of the receiver condition, tracked satellites, location, altitude, current firmware, receiver board ID and serial number, memory capacity, log files and more.

- **Satellite** menu – shows the list of the satellites and constellations with satellites parameters. The satellite parameters shown are satellite elevation, azimuth, signal-to-noise ratios, and tracking times. Use the **Settings** menu to change monitored and used satellite signals.
- **Status** menu – shows specified information about the receiver’s position, data links, position in time, a skyplot, scatter plot and spectrum analyzer.
- **Settings** menu – gives the ability to change the receiver parameters. It has these submenus:
 - **Positioning** - to change the positioning mode, parameters for satellite observation, and enable solutions.
 - **Base** - to configure a reference base station.
 - **RTK** - to set up the RTK rover.
 - **Satellites** - to adjust which satellites are used by the tracking and positioning calculation.
 - **Ports** - shows the available receiver ports and enables input and output customization.
 - **Bluetooth** - to get access to and change the LongLink, client, and BLE parameters.
 - **Network** - to configure and manage the Wi-Fi module and configure TCP/IP settings.
 - **Radio Modem** - to change radio modem settings.
 - **Cell Modem** - to see the condition of the cell modem, configure the cell modem, and tell the modem to connect to a GSM Network or another cell modem.
 - **NTRIP** - to configure NTRIP functionality and review caster statistics.
- **Management** – to update the GNSS receiver firmware, load option authorization files (OAF), import/export receiver settings, and reset the device.
- **About** – gives information about the currently connected receiver, it’s related hardware and firmware versions, battery conditions, and more.
- **Files** – gives access to the folders and files saved in the receiver’s memory, download, and customization of the recorded message sets for data logging.
- **Terminal** – sends GRIL commands to the receiver.

Option Authorization Files

Sokkia makes available an option authorization file (OAF) to enable the specific purchased options. The Sokkia OAF system lets you change and configure the receiver for your particular requirements.

Load an OAF

1. Connect the GRX5 GNSS receiver to a field controller or computer and open the on-board web UI (Figure 2-17).
2. Open the **Management** menu, then select **UPLOAD OAF**.
3. Select **UPLOAD OAF** in the **Choose File** box to open a window from which to select the new OAF file.

4. Open the location of the new OAF (*.tpo), select this file, then select Open.
5. Select **UPLOAD OAF** to start the process to apply the new option file.

Once uploaded, the receiver resets to apply the changes.

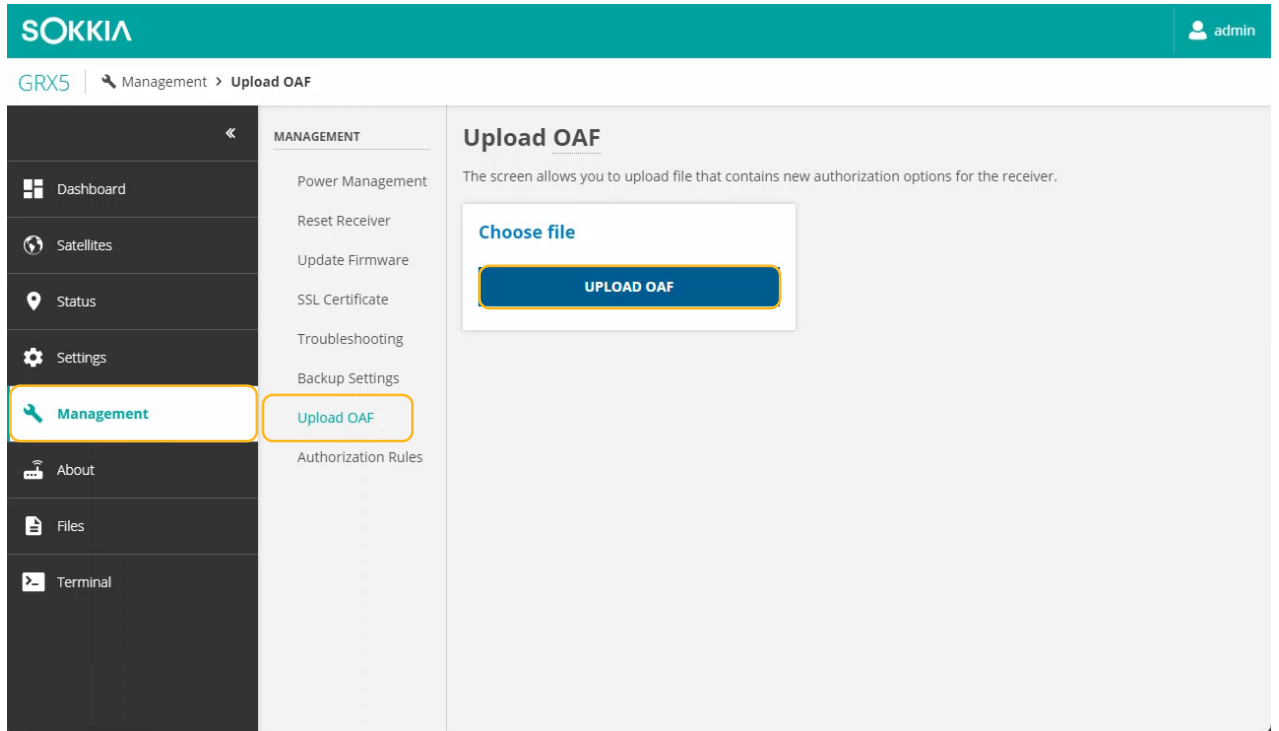

Figure 2-17: Load an OAF

Receiver OAF Verification

1. Connect the GRX5 GNSS receiver to a field controller or computer and open the on-board web UI.
2. Open the **About** menu, then select **Options**.

This shows all currently available options that are approved for the receiver (Figure 2-18). Scroll through the list to see the current approved options that are installed on the receiver.

The screenshot shows the SOKKIA web interface for the GRX5 receiver. The 'About' menu is open, and the 'Options' sub-menu is selected. The 'Receiver Options' page is displayed, showing a table of installed OAFs. The table has columns for Name, ID, Current, Permanent, Leased, and Expired Date. The 'Tracking' tab is active, showing a list of signals with their IDs and expiration dates.

Name	ID	Current	Permanent	Leased	Expired Date
Tracking					
GPS L1 Signals	GPS1	Yes	No	Yes	11/27/2024
GPS L2 Signals	GPS2	Yes	No	Yes	11/27/2024
GPS L5 Signals	GPS5	Yes	No	Yes	11/27/2024
GLONASS L1 Signals	GL01	Yes	No	Yes	11/27/2024
GLONASS L2 Signals	GL02	Yes	No	Yes	11/27/2024
GLONASS L3 Signals	GL03	Yes	No	Yes	11/27/2024
Galileo E1 Signals	GAL1	Yes	No	Yes	11/27/2024
Galileo E5 Signals	GAL5	Yes	No	Yes	11/27/2024
Galileo E6 Signals	GAL6	Yes	No	Yes	11/27/2024
BeiDou B1 Signals	BDS1	Yes	No	Yes	11/27/2024
BeiDou B2 Signals	BDS2	Yes	No	Yes	11/27/2024
BeiDou B3 Signals	BDS3	Yes	No	Yes	11/27/2024
SBAS L1 Signals	SBA1	Yes	No	Yes	11/27/2024

Figure 2-18: Installed OAFs on the Receiver

Cellular Modem Configuration

The GRX5 GNSS receiver has an integrated 4G/LTE cellular modem that transmits and/or receives GNSS differential corrections.

A cellular service plan is necessary, and wireless service is available only in the operating range of the network.

Integrated Radio Configuration

The GRX5 GNSS receiver is available with an optional internal radio modem. This section tells how to configure the radio through the on-board web UI.

See Table 2-1: for GRX5 assemblies, part numbers and related radio antennas to identify which receivers contain an integrated radio and their specified frequency bands.

To connect and get access to an internal radio modem in the receiver:

1. Connect the receiver to a field controller or computer to open the on-board web UI.
2. Open the **Settings** menu, then select **Radio Modem** (Figure 2-19).

This shows the installed radio modem model, the current hardware/firmware versions and modem serial number on the **General** tab.

The screenshot displays the SOKKIA web interface for the GRX5 receiver. The top navigation bar shows the SOKKIA logo and a user profile for 'admin'. The breadcrumb trail indicates the path: GRX5 > Settings > Radio Modem. On the left, a dark sidebar contains menu items: Dashboard, Satellites, Status, Settings (highlighted with a yellow border), Management, About, Files, and Terminal. A secondary settings sidebar lists various configuration categories: Positioning, Base, RTK, Satellites, Ports, Bluetooth, Network, Radio Modem (highlighted with a yellow border), Cell Modem, and NTRIP. The main content area is titled 'Radio Modem' and includes the instruction: 'The screen allows to change radio modem settings.' It features an 'Enable' toggle switch, a 'Current State' indicator showing 'CONNECTED' in a green box, and a blue 'DISCONNECT' button. Below these are three tabs: 'General' (selected), 'Settings', and 'Upload MCF'. The 'General' tab displays the following information for the 'SATEL SATEL-TR4+' modem:

Firmware Version	V07.45.2.5.2.34
Hardware Version	SPL0053g, 1.9
Product Code	No version id
Serial Number	2305000010
Call Sign	

Figure 2-19: Radio Modem Settings

- To get access to and change the radio modem settings, select the **Settings** tab (Figure 2-20).
- Select **Apply Changes** at the bottom of the screen to enable settings that were changed.

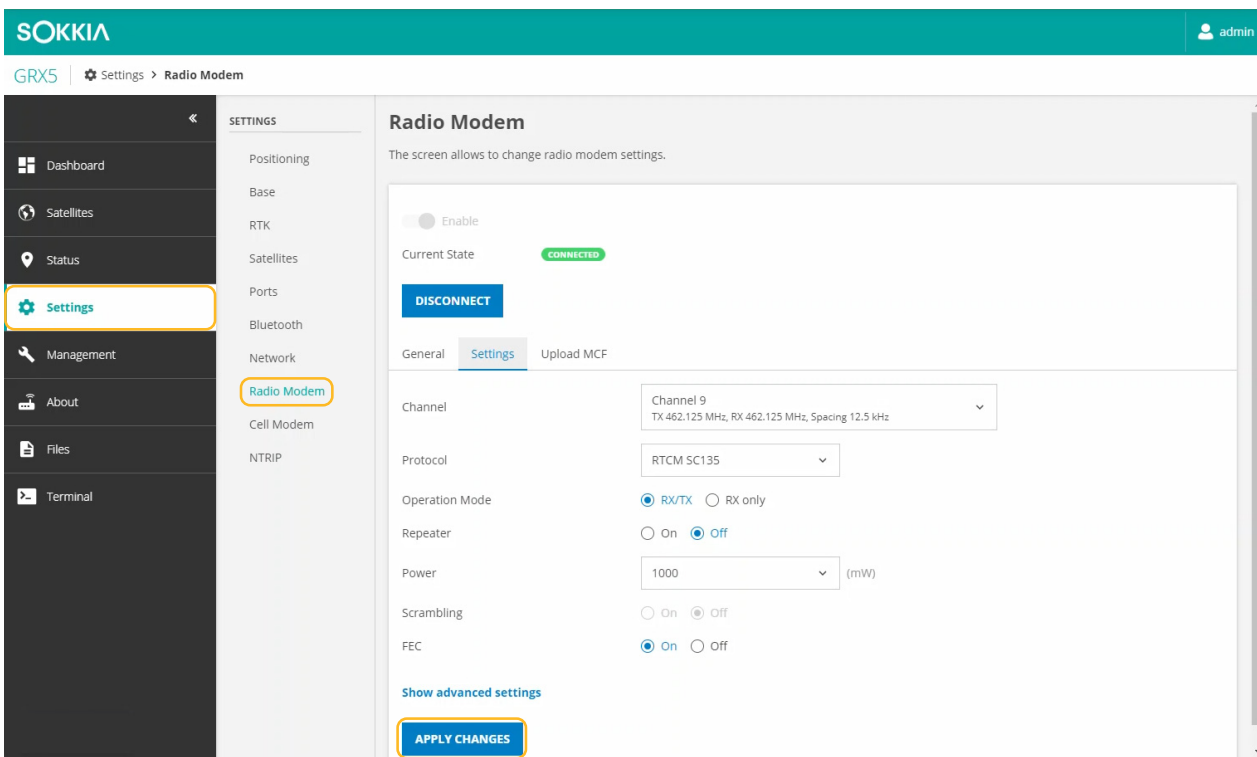

Figure 2-20: Change Radio Modem Settings

Modem Configuration File Creation

The instructions that follow tell how to make and load a modem configuration file (*.mcf) for GRX5 GNSS receivers with a UHF radio modem that operates in the licensed frequency band of 403 MHz to 473 MHz.



NOTE

The Sokkia dealer must configure and load a valid configuration file with your specified UHF frequencies before you get the receiver. Regional UHF frequencies can be licensed or unlicensed, but restrictions in the 403 MHz to 473 MHz range apply. Failure to understand and apply this procedure can cause non-operation of the modem or breach of local regulatory laws. Write to Topcon technical support (support@topcon.com).

To make a dealer modem configuration file (*.MCF):

- Download and install the Sokkia Receiver Utility (SRU) version 3.7 or higher on a Windows device.

A valid Dealer/Advanced license for SRU is necessary.

- Open SRU.
- Select **Device > Application Mode > Frequency Editing**.

The **SRU** screen opens (Figure 2-21).

4. Select **Satel** from the list of modems.

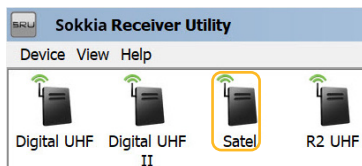

Figure 2-21: SRU Modems

5. Select **Dealer Configuration** .

The **MCF Creator** screen for a SATEL-TR4+ modem opens (Figure 2-22).

6. Select **Add**.

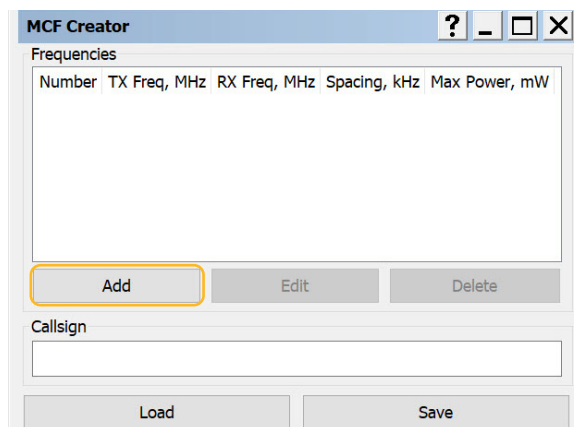

Figure 2-22: MCF Creator

The **MCF Entry** screen opens (Figure 2-23).

7. Enter the modem parameters.
8. Select **OK**.

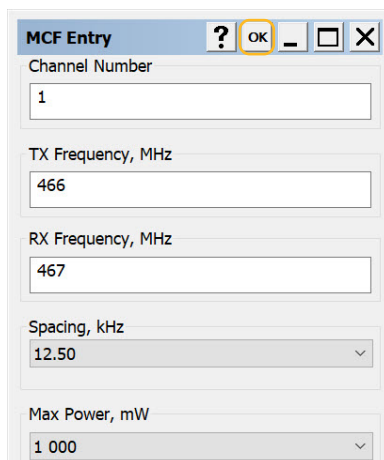

Figure 2-23: MCF Entry

The **MCF Creator** screen opens.

9. Select **Save**. A file with a *.MCF extension is made for the SATEL-TR4+ modem.

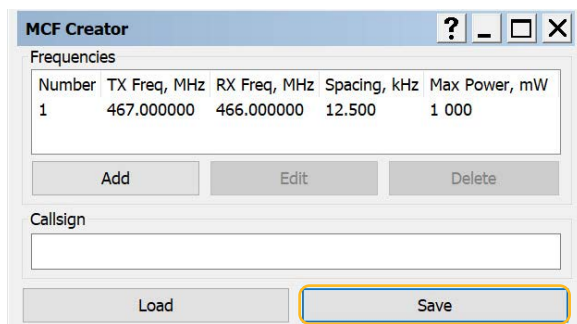

Figure 2-24: MCF Creator with Extension

Modem Configuration File Loading

To load a *.MCF file into a GRX5 GNSS receiver with the integrated UHF modem:

1. Connect the receiver to a field controller or computer to open the on-board web UI.
2. Open the **Settings** menu, then select **Radio Modem** to show the installed radio modem model, its current hardware/firmware versions, and modem serial number on the **General** tab.
3. Select the **Upload MCF** tab, then select **UPLOAD MCF**.
4. Open the folder in which the dealer configuration file *.MCF is stored, then select **OK**.
5. Select **UPLOAD MCF** to execute the upload process and apply the radio frequency settings that are specified in the *.MCF file.

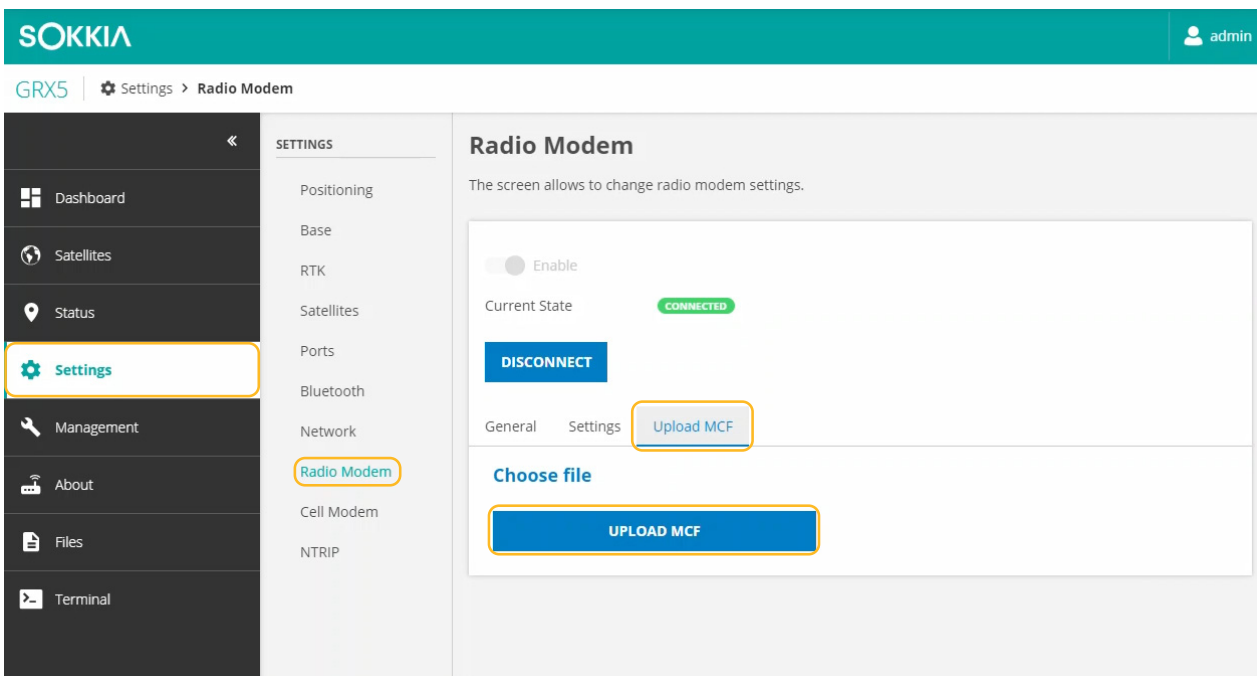

Figure 2-25: Upload MCF File

Memory

The GRX5 GNSS receiver has an internal, non-removable, industrial 32 GB memory card. The memory card is formatted as ext4, a Linux file system that is compatible with Windows and other operating systems.

Data Recording

The GRX5 GNSS receiver records the GNSS data in a *.tps file format. The files and folders are in a hierarchical structure. A total of 4000 files can be recorded and saved in the internal memory.

The receiver can be configured to:

- Record a maximum of 2 simultaneous *.tps data files. Each file can be recorded with its specified parameters.
- Close the current log file and open a new one in compliance with a user-defined schedule. This is known as automatic file rotation mode (AFRM).
- Automatically overwrite the older files to make room for the new files, using storage quotas of existing files.
- When a survey is completed, connect the receiver to a computer or field controller to download the *.tps data files for storage, post-processing, or backup.

Data Recording with the Power Button

To use the **Power** button to record data:

1. Set the receiver power to ON and look at the LED screen to make sure that the receiver is prepared (see “Power Button” on page 2-10.)

When the Power LED does not flash yellow, the receiver is prepared to record data.

2. Push the Power button three times in 2 seconds to record data.
3. Make sure that the REC LED flashes green, which shows that a *.tps data file is open and a data recording process started.
4. The REC LED flashes during the data recording process.

If the REC light flashes red, the internal memory is near full.

5. Push the Power button three times in 2 seconds to stop the data recording process.
6. Make sure that the REC LED does not flash.

Data Recording with the Web UI

1. Connect the receiver to a field controller or computer to open the on-board web UI (Figure 2-26).
2. Open the **Files** menu, then select **Data Logging** to show the log file settings.
3. Select **Start Logging** to start a new data recording.

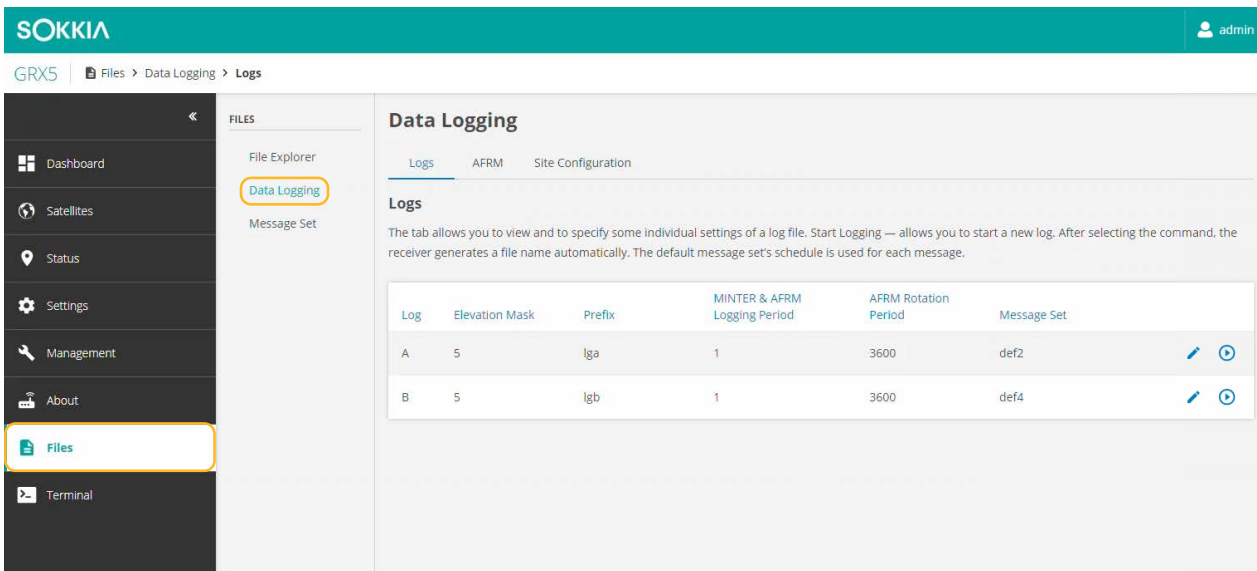

Figure 2-26: Data Logging - Logs

4. Select the **AFRM** tab to enable AFRM (Figure 2-27).

In this mode, the receiver closes the current log file and opens a new one in compliance with a schedule set by the File Rotation Period and File Rotation Phase parameters.

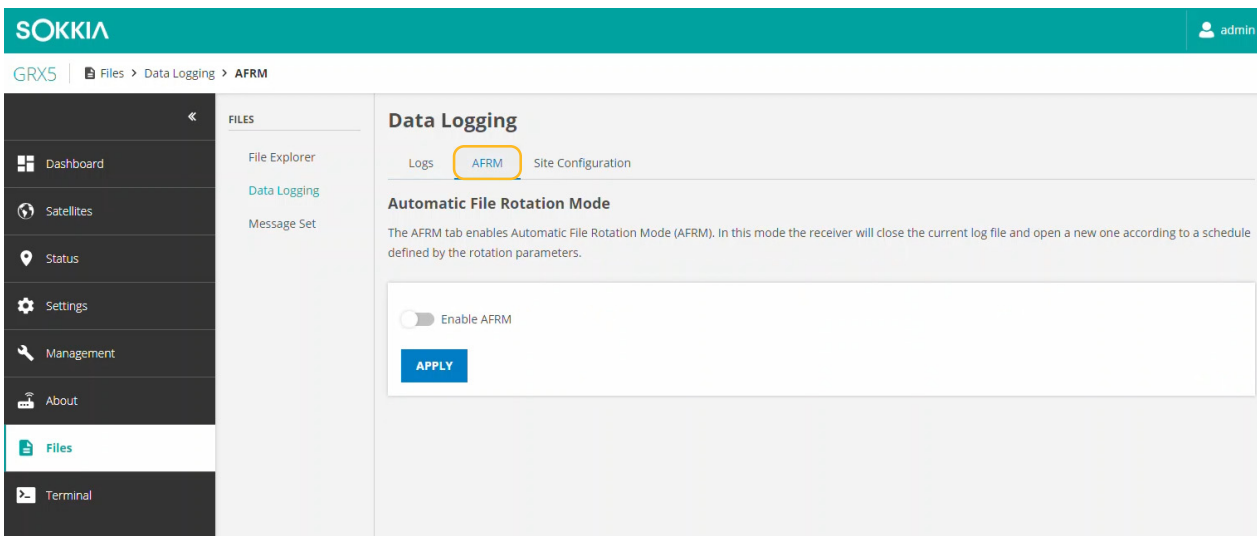

Figure 2-27: Data Logging - AFRM

5. Select the **Site Configuration** tab to edit site and antenna parameters for data logging.

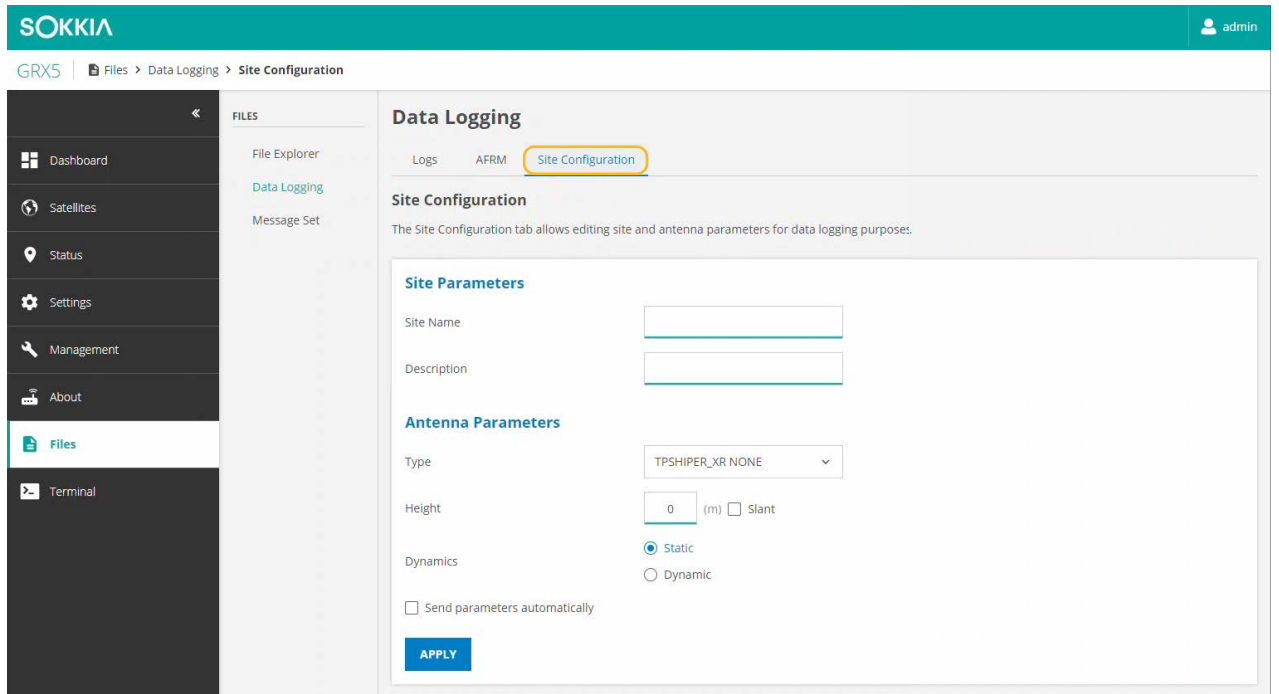

Figure 2-28: Site Configuration

Raw Data Transfer

To access and download the raw GNSS *.tps data file(s) that are saved in internal memory:

1. Connect the receiver to a field controller or computer to open the on-board web UI (Figure 2-29 on page 2-27).
2. Open the **Files** menu, then select **File Explorer** to show the raw data files in the internal memory.
3. Select a log file, then select **DOWNLOAD**.

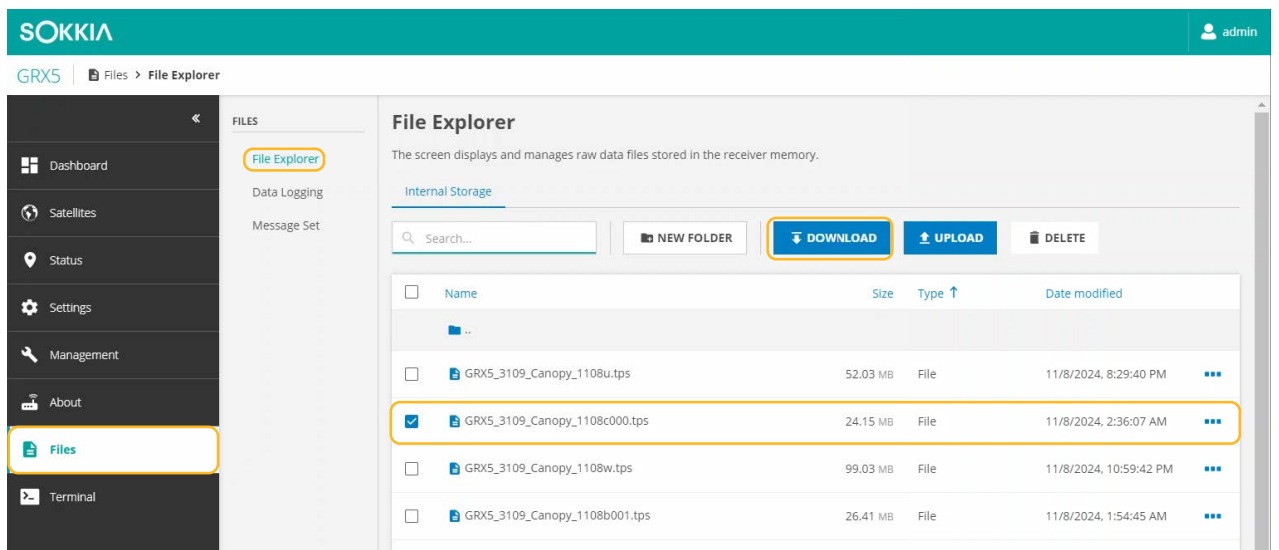

Figure 2-29: Log File Download

File Deletion

To delete recorded data file(s) from internal memory:

1. Connect the receiver to a field controller or computer to open the on-board web UI (Figure 2-26).
2. Open the **Files** menu, then select **File Explorer** to show the raw data files in the internal memory.
3. Select a log file, then select **DELETE**.

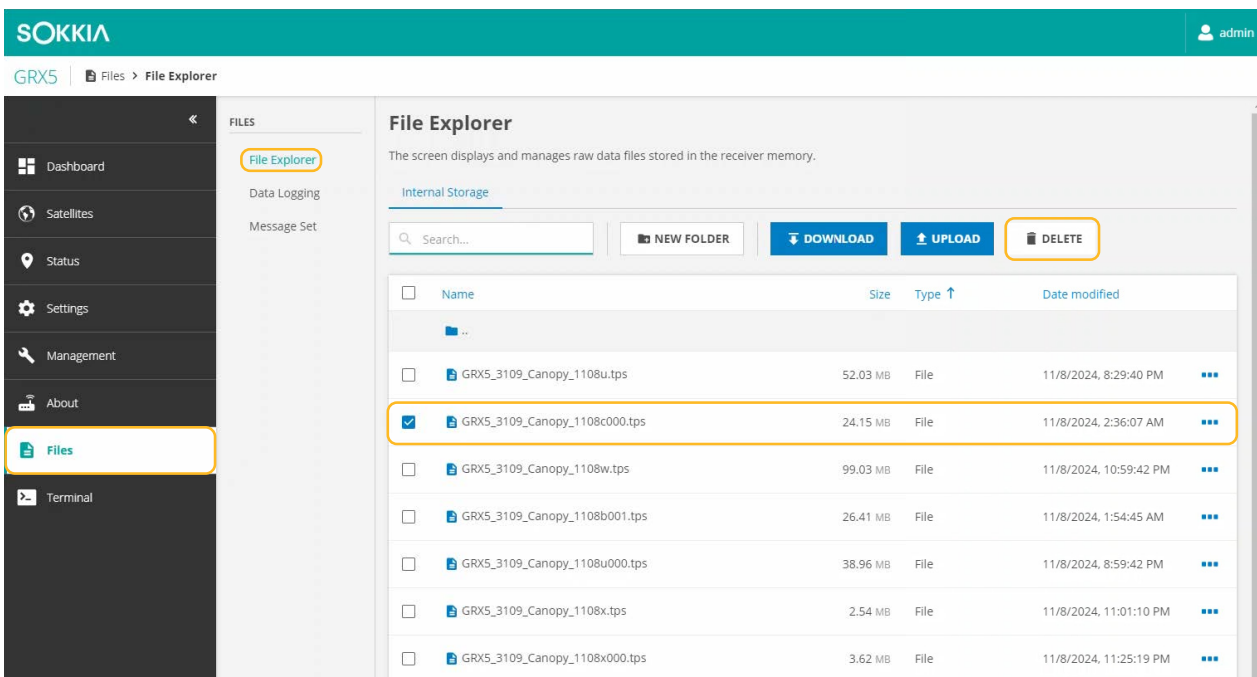

Figure 2-30: Delete Log File

Default Setting

Parameter Reset

There are two methods to do a parameter reset. The Power button (see “Power Button” on page 2-10) or the web UI can be used.

To reset the GRX5 GNSS receiver parameters using the receiver web UI:

1. Connect the GRX5 GNSS receiver to a field controller or computer and open the on-board web UI (Figure 2-31).
2. Open the **Management** menu, then select **Reset Receiver** to show the available options.
3. Select **RESET SETTINGS**.
4. A dialog opens to show information about the parameter reset.
5. Select **CONFIRM** to continue with the settings reset.

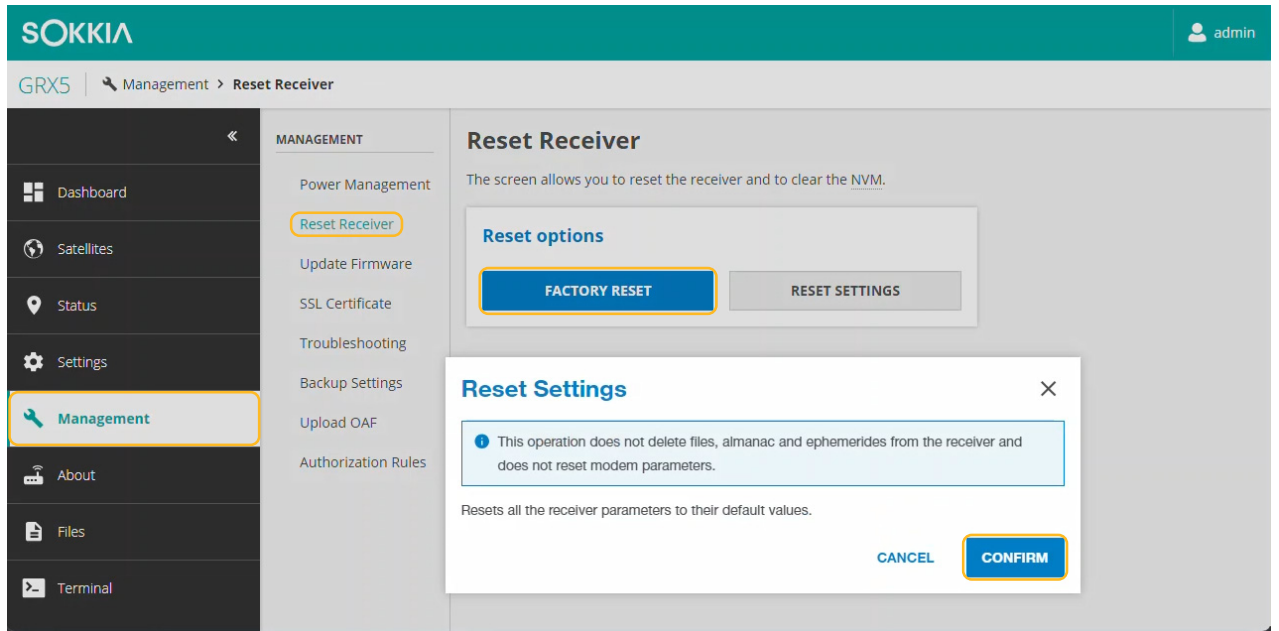

Figure 2-31: Reset Parameters

Firmware Update

Watch for new receiver firmware versions from Sokkia or Sokkia dealers and update the receiver's firmware for new GNSS features. Sokkia frequently updates the firmware that controls Sokkia receivers.

Open the myTopcon NOW! site for access to the newest firmware. Scan the QR code on the product identification label on the bottom of the receiver, or open a network browser and enter <https://mytopconnow.topconpositioning.com/>.

Download and Update Firmware

1. Download the latest firmware for the GRX5 GNSS receiver from <https://mytopconnow.topconpositioning.com/> (requires login ID).
2. Save the .itb file in a folder on the hard drive of the field controller or computer to used to connect to the receiver.
3. Connect the receiver to a field controller or computer with a USB Type-C cable (see "USB Type-C Connector" on page 2-14).
4. Open the **Management** menu on the web UI and select **Update Firmware** (Figure 2-32).

The web UI dashboard of the shows the receiver's current firmware version.

5. Select **UPDATE**.
6. Select the downloaded firmware file, then select **OPEN**.

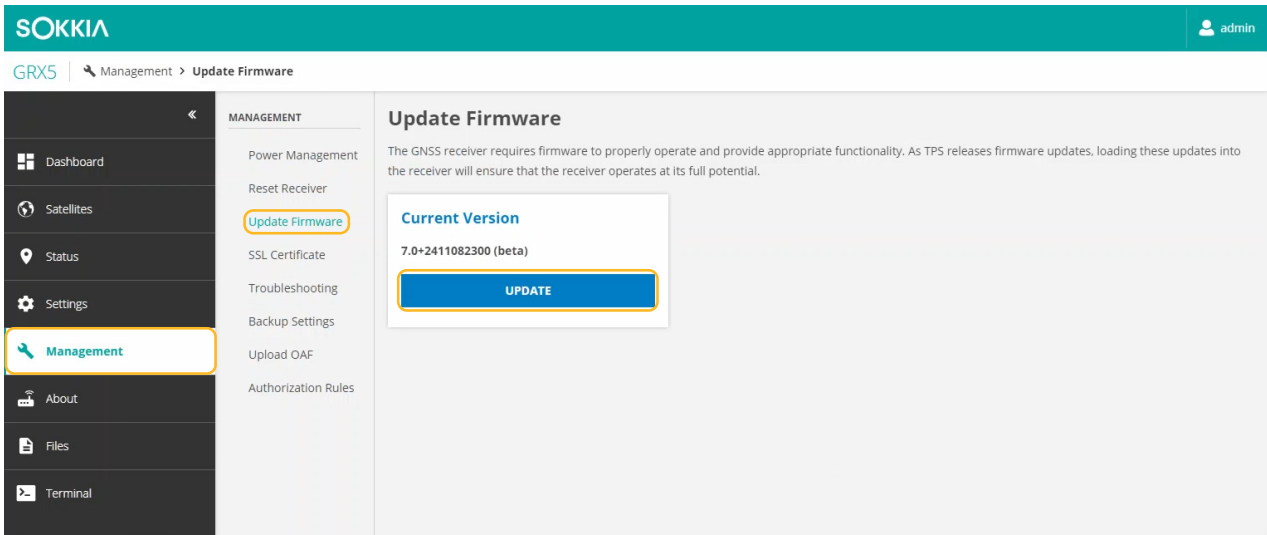

Figure 2-32: Web UI Firmware Update

The **Installation** screen shows the firmware upload and installation in progress.

7. Do not stop the receiver while an update is in progress.
8. After the installation is complete, the receiver disconnects and automatically restarts.



NOTE

Firmware files for the GRX5 GNSS receiver have the *.itb extension.

9. Make sure that the firmware is the current version:
 - a. Connect the receiver to the field controller or computer to open the on-board web UI.

The **Dashboard** and **About** menu show the currently loaded receiver firmware.
 - b. Make sure that this firmware version is the same as that of the firmware update file.

Field Setup

The GRX5 GNSS receiver can be configured to record raw GNSS data in the integrated memory. The measurement data can then be post-processed with raw GNSS data from a different static receiver to calculate an accurate position.

Static GNSS survey procedures can find solutions to systematic errors when very accurate positioning is necessary. Static procedures record data for a period of time during which the satellite geometry changes to make baselines between stationary GNSS units. The post-processed GNSS data are used to apply control network measurements and for accurate monitoring.

Data can be saved in the internal memory of the receiver, on a field controller, tablet, or computer (see “Data Recording” on page 2-25).

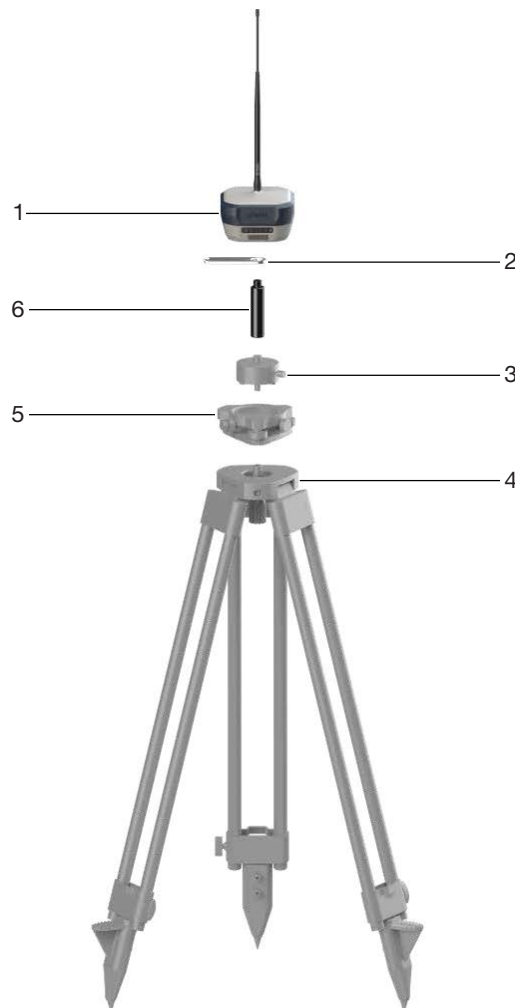

- | | | | | | |
|---|----------------------------------|---|------------------|---|---------------------|
| 1 | GRX5 GNSS receiver | 3 | Tribrach adapter | 5 | Tribrach |
| 2 | Slant measurement height bracket | 4 | Wooden tripod | 6 | 100 mm prism spacer |

Figure 3-1: General Static Setup

Receiver as Base Station Setup

An RTK base station is a GNSS receiver that is put at a known (and fixed) position. The base station monitors the same satellites as the RTK GNSS rover receiver. The errors in the GNSS system are monitored at the base station, with a message set of differential corrections calculated and transmitted to the RTK rover. These messages are sent through a data link to the RTK rover to correct the real-time positions of the GNSS rover.

The base station receiver is set up on a tripod over the base station marker. It transmits GNSS corrections to rovers. The base station in static or post-processed kinematic occupation records GNSS raw data for further you post-processing by a dedicated application, for example, Topcon Tools.

General guidelines for GRX5 GNSS receiver operation as a base station:

- Put the GNSS base station where it has a clear view of the sky. Do not set up the base station receiver in an area with blockage of the sky, for example, buildings or tree canopy.
- Do not set up the receiver directly below or near overhead power lines or electrical generation facilities. Electromagnetic fields can cause interference with GNSS receiver operations.
- Put the GNSS base station at a safe and stable location.
- Select the applicable radio antenna for the frequency band used to transmit GNSS differential corrections.
- Make sure that the receiver is fully charged.
- Connect an external power supply to operate the receiver for a longer time.
- Sokkia recommends that, when possible, to keep the receiver equipment dry. Although the receivers are resistant to wet weather, dry ports and connectors decreases the effects of corrosion. If the base station equipment becomes wet, use a clean dry cloth to make the equipment dry.

Figure 3-2 on page 3-3 shows a typical base station setup with a tripod and tribrach. The receiver is installed on the tribrach that is attached to the tripod.

1. To measure the height of the base station with the slant height measurement bracket, measure from the control point on the ground (5, Figure 3-2) to the slant height measurement point on the bracket (7, Figure 3-2).
2. Enter this slant height into the field software (or web UI).

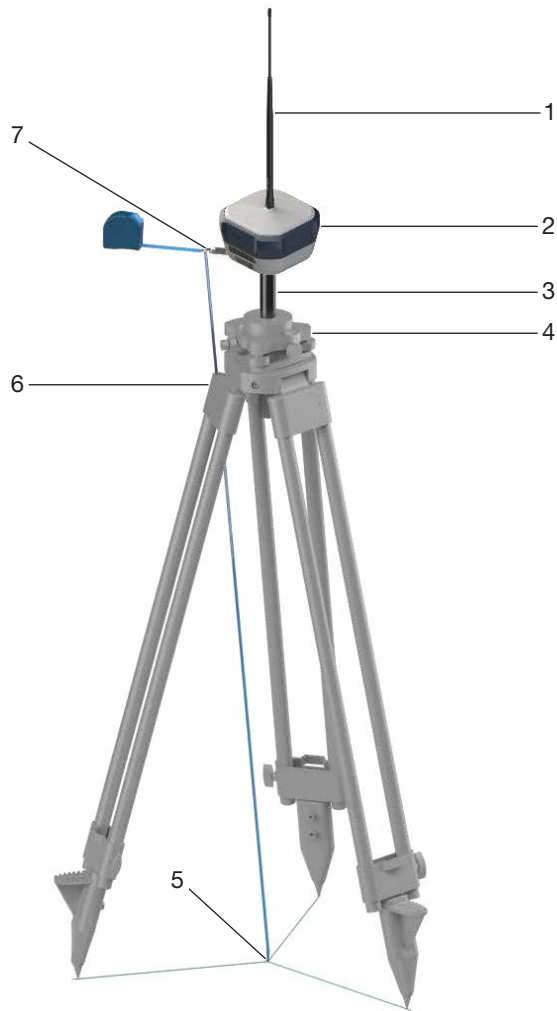

- | | | | | | |
|---|---------------------|---|-----------------------|---|----------------------------------|
| 1 | Radio antenna | 4 | Tribrach with adapter | 7 | Slant measurement height bracket |
| 2 | GRX5 GNSS receiver | 5 | Control point | | |
| 3 | 100 mm prism spacer | 6 | Wooden tripod | | |

Figure 3-2: Base Station Setup Slant Height

The base station can be installed directly on a fixed height tripod with the 5/8-11 in. threaded socket (Figure 3-3 on page 3-4). The antenna reference point of the receiver is the bottom of the receiver housing. When the receiver is directly installed on the tripod, the height of the tripod is the vertical height measurement to be entered in the field application software or web UI.



NOTE

The slant measurement height bracket is not necessary when a fixed height tripod is used. See Figure 3-3 on page 3-4 for a typical fixed height tripod setup.

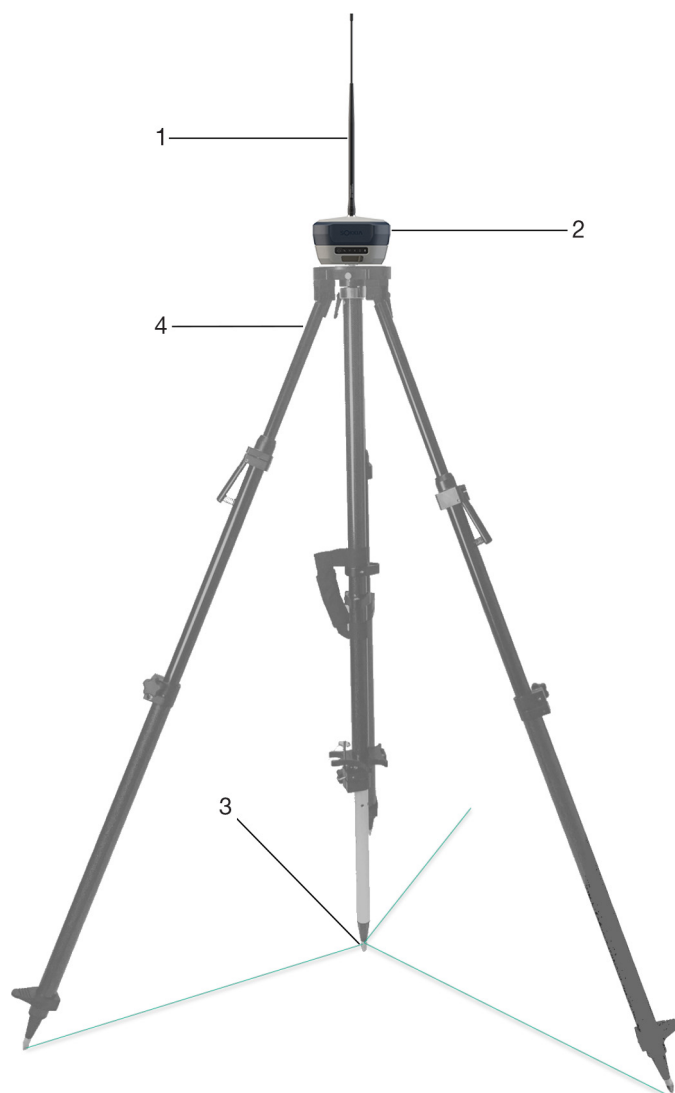

- | | | | |
|---|--------------------|---|---------------------|
| 1 | Radio antenna | 3 | Control point |
| 2 | GRX5 GNSS receiver | 4 | Fixed height tripod |

Figure 3-3: Fixed Height Tripod Base Station Setup Vertical Height

3. With the GRX5 GNSS receiver set up on a tripod above the control point at a safe and stable location, connect the receiver to a field controller with Topcon field application software (Topcon Field or Pocket 3D), or to the receiver web UI.
4. Configure the position of the base station and the antenna height (slant or vertical), select the differential corrections message set for output, and the method of transmission (Radio, LongLink, Cellular).

Base Station Transmission Methods

Internal Radio Modem

To set up the GRX5 GNSS receiver as a base station with the (optional) integrated radio:

1. Connect the receiver to a field controller or computer to open the on-board web UI.
2. Open the Settings menu, then select **Base**.
3. Select **SOKGRX5 NONE** from the Antenna Type drop-down list.
4. Select the **Antenna Reference Point (ARP)** radio button.
5. Set the position of the base station control point, or select **GET FROM THE RECEIVER** if the base station setup is above an unknown point.
6. Select **APPLY CHANGES** to use these settings.

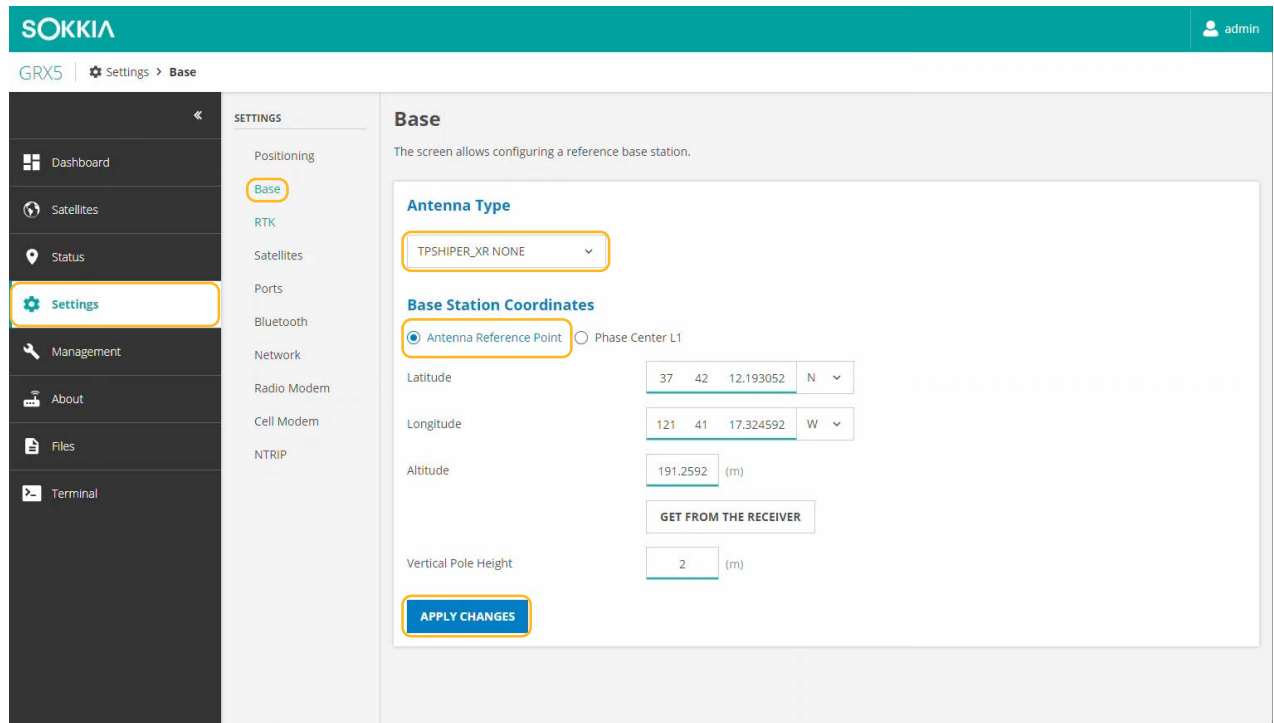

Figure 3-4: Base Station Settings

7. Select **Radio Modem**.
8. Make sure that the configured parameters are correct.

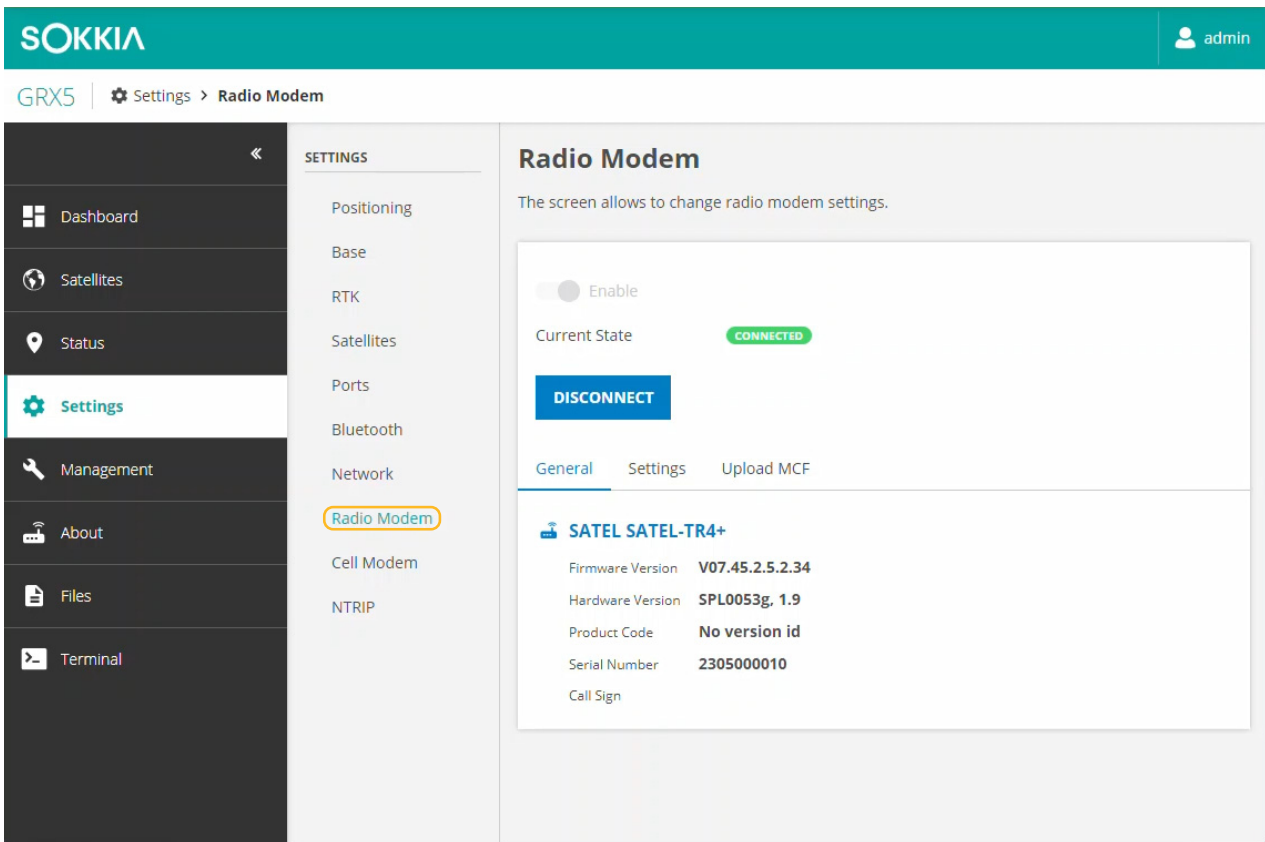

Figure 3-5: Radio Modem Parameters

LongLink

All GRX5 receiver models have integrated LongLink Bluetooth technology. A maximum of three wireless RTK rover connections is possible. LongLink operates for base station/rover RTK systems. You can also connect the receiver to other Bluetooth devices (for example, field controllers and computers) at the same time with Bluetooth wireless technology and LongLink Bluetooth connections.

The Topcon LongLink Bluetooth technology enables communication of RTCM3 differential corrections between GRX5 receivers with Bluetooth (up to 300 meters), which makes more external radio corrections unnecessary.



NOTE

Environmental and field conditions have an effect on the maximum distance of LongLink operation.

Receiver as Rover Setup

As a rover, the GRX5 GNSS receiver has a full set of communication modules to receive GNSS corrections from an available field source.

Table 3-1: Available GNSS Corrections

Corrections	Source
Satellite Based Augmentation System (SBAS)	Differential corrections from SBAS satellites (WAAS, EGNOS, ... that enable the rover to operate with a DGNSS solution)
Differential GNSS (DGNSS)	DGNSS base station that transmits RTCM corrections through: <ul style="list-style-type: none"> • LongLink • Radio • Network.
Real Time Kinematic (RTK)	RTK base station that transmits corrections through: <ul style="list-style-type: none"> • LongLink • Radio • Network

Use a field controller that runs the Topcon field software to configure the receiver as an RTK rover in the field. If necessary, see the software documentation for how to connect, configure, and control the receiver.

For an RTK survey operation, the receiver can be used as a base station to transmit GNSS corrections or as a rover to receive GNSS corrections in real-time. The corrections can be transmitted or received through UHF, Bluetooth LongLink, or through network corrections, for example, an integrated cellular modem or internet connection through the field controller.

Standard RTK GPS surveys are kinematic GNSS surveys that are done with a data transfer link between a reference GNSS base station and rover(s). The field survey is done equivalent to a kinematic survey, with measurement data from the base station transmitted to the rover unit(s), that enables the rover unit(s) to calculate the position in real-time. The derived solution comes from one baseline vector from the base station to the rover unit(s).

A standard RTK system has a GNSS base station, one or more rovers, and a data transfer link between the base station and the rover unit(s). Usually, the RTK rover unit is has a GNSS receiver, an antenna, a field controller with application software, and a rover pole.

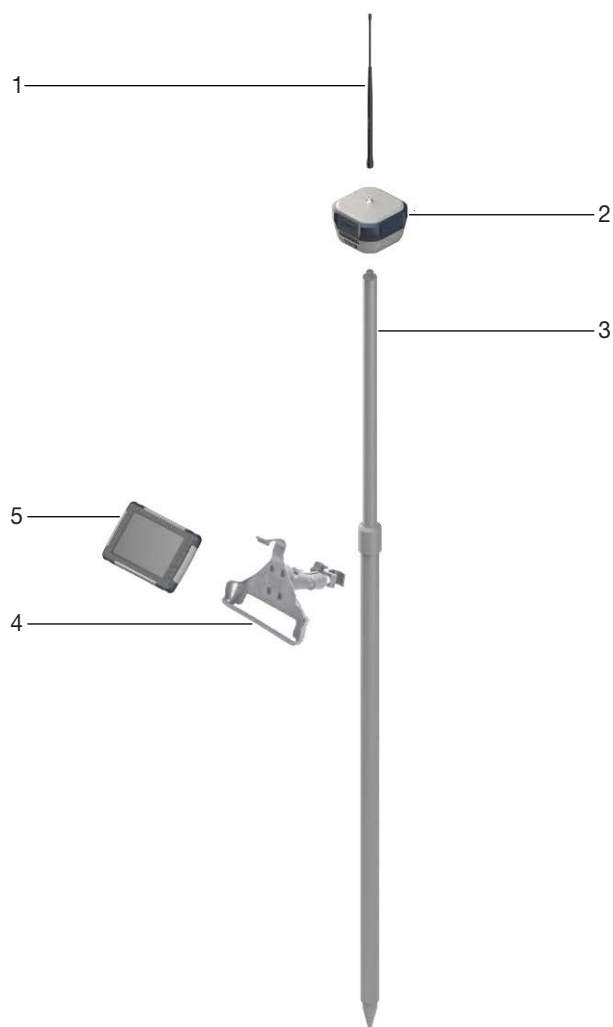

- | | | | | | |
|---|--------------------|---|--------------------------|---|------------------|
| 1 | Radio antenna | 3 | Survey range pole | 5 | Field controller |
| 2 | GRX5 GNSS receiver | 4 | Field controller bracket | | |

Figure 3-6: General RTK Rover Setup

Rover Operation Guidelines

Real-Time Kinematic (RTK) operation supplies centimeter-level accuracy through correction of errors in the GNSS system. A source of GNSS corrections from a local base station or a network of base stations is necessary for RTK operations. The Sokkia GRX5 GNSS receiver with TILT technology, can increase the accuracy of GNSS-only RTK operation through integration of GNSS and IMU sensor data. This enables real-time awareness of system attitude. The GRX5 accurately calculates the tip position of the range pole when the rover is vertical or tilted.

This overview includes the principles of rover operation, with guidance on optimal setup location selection and equipment setup.

The GRX5 RTK rover, which moves between measurement or stakeout points, connects to a base station to get RTK differential corrections through:

- The integrated radio modem
- The integrated LTE cellular modem

- A network connection from the Field Controller
- LongLink Bluetooth

Obey the setup guidelines for good rover operation:

- Put the receiver in a location with a clear view of the sky from all angles. Be careful when you attach the antenna near vertical blockage, for example structures, tree canopy, and overhead transmission lines. These can have an effect on how the rover monitors GNSS signals.
- For the RTK rover to get a RTK fixed solution, the base station and rover must have access to the same satellite signals. A minimum of five satellites is necessary for RTK positioning.
- For centimeter precision during the survey, communications between the base station and rover must stay ON. The base station and rover must also monitor equivalent satellite signals.
- Use GNSS planning software to identify optimal and unsatisfactory coverage times to schedule measurements, especially in GNSS environments with blockage and/or interference.
- When the receiver gets corrections through a radio modem, make sure that the RTK rover has a clear line of sight to the base station for radio reception. It is necessary to be near the radio for communication. During operation with a cellular modem for RTK corrections, know your network coverage and possible locations where cellular service is not available.
- Correct integrated IMU alignment is necessary for dynamic TILT compensation. This is done after the survey is started, or during the survey if alignment is lost. The alignment process is usually fast and frequently occurs automatically during usual rover operation. If alignment is temporarily lost, a realignment occurs, and the use of TILT can continue when the IMU has applicable dynamic data.

RTK Rover Setups to Receive Corrections

General Rover Setup

1. Use the 5/8-11 in. threaded insert to attach the GRX5 receiver to the survey pole.
2. Make sure that it is correctly attached.
3. Measure the height of the receiver from the ground.

When you use a fixed height survey pole, record the measurement reading to enter the antenna height into the software for a vertical height.

4. When you use an internal radio modem, attach the related radio antenna to the receiver. See Figure 2-4 on page 2-3 to identify the correct radio antenna for the frequency range.
5. Push and hold the **Power** button for 2 seconds to set the receiver power to ON.
6. Use Topcon/Sokkia field software such as Topcon Field or Pocket 3D to launch the software on the field controller and connect to the rover receiver through Bluetooth, USB, or Wi-Fi.
7. Configure the receiver for the communication method to receive corrections (UHF radio, LongLink Bluetooth, or cellular modem).

Integrated Radio Modem

1. Select the receiver with the UHF radio modem.
2. Set the elevation mask angle.
3. Set the antenna height.
4. Select the RTK input message format.
5. Select the related internal radio model.
6. Configure the UHF radio modem parameters:
 - protocol
 - modulation
 - scrambling
 - FEC
 - frequency channel

Integrated Cellular Modem

1. Select the receiver with the internal cellular modem.
2. Set the type of data to use for the job configuration:
 - VRS
 - Single Base
 - Topcon Relay
3. Select the protocol of the input correction data:
 - NTRIP 2.0/1.0
 - NTRIP 1.0
 - TCP/IP
4. Set the elevation mask angle.
5. Set the antenna height.
6. Select the RTK input message format:
 - IP address and TCP port number of the remote server
 - a password and user ID to login to the selected server

Dynamic TILT Compensation

The Topcon integrated Dynamic TILT Compensation technology lets you get the correct pole tip position independently of the pole inclination. It operates immediately. Dynamic TILT Compensation with the Hybrid Inertial Measurement Unit (HIMU) sensor makes setup easy without time-consuming calibration procedures. It does not use magnetometer data and magnetic disturbances have no effect. Measurements near metal constructions can be made without decreased performance.

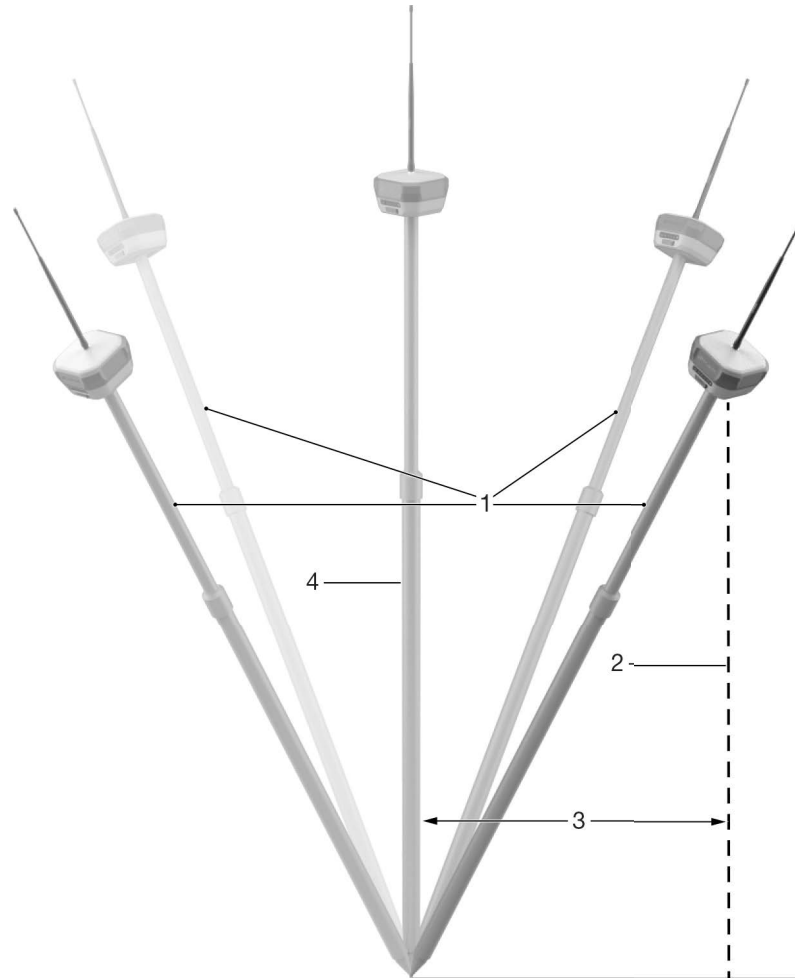

- | | |
|--|---------------------------------------|
| 1 TILT pole incline | 3 Offset dN/dE |
| 2 False projection of the phase center | 4 True projection of the phase center |

Figure 3-7: TILT Alignment Positions

Dynamic TILT Setup

1. Open Topcon Field.
2. Open Topcon Field context menu, then select **Tilt Settings** to open the **TILT Settings** screen (Figure 3-9).

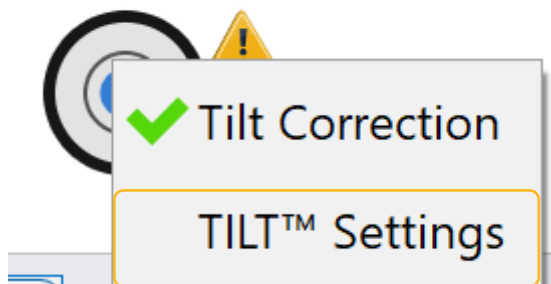

Figure 3-8: Topcon Field Context Menu

3. Select the **Show eLevel** checkbox.



NOTE

The virtual bubble shows on the screen (Figure 3-13 on page 3-15) when the **eLevel** checkbox is selected. The virtual bubble shows green when the pole inclination is within parameters. It shows red when the pole inclination is out of parameters.

4. Select the **Compensate** radio button in the **Pole tilt handling** group.
5. Select **Next**.

Figure 3-9: TILT Settings

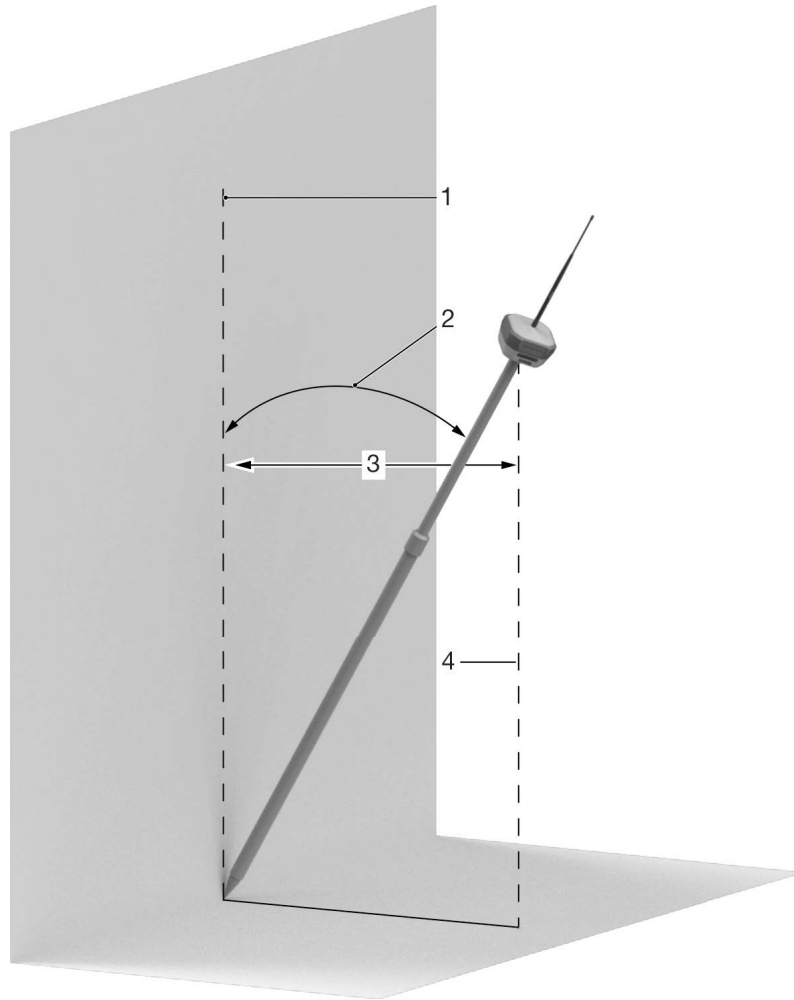

- | | |
|---------------------------------------|--|
| 1 True projection of the phase center | 3 Offset dN/dE |
| 2 TILT pole incline | 4 False projection of the phase center |

Figure 3-10: TILT Correction Mode Impeded Movement

TILT Compensation Operation

Dynamic TILT is enabled when the **Compensate** radio button is selected on the **TILT Settings** screen (Figure 3-9 on page 3-12). TILT operation is fully controlled by Topcon Field. Dynamic TILT automatically starts operation after setup. Status information shows on the **Survey** screen as a text label and icon in Topcon Field. **Reset TILT** is a **Setup** menu item in TILT compensation mode. Refer to the Topcon Field online Help for more information.



NOTE

Sokkia recommends to select **Reset TILT** before you start a new survey.

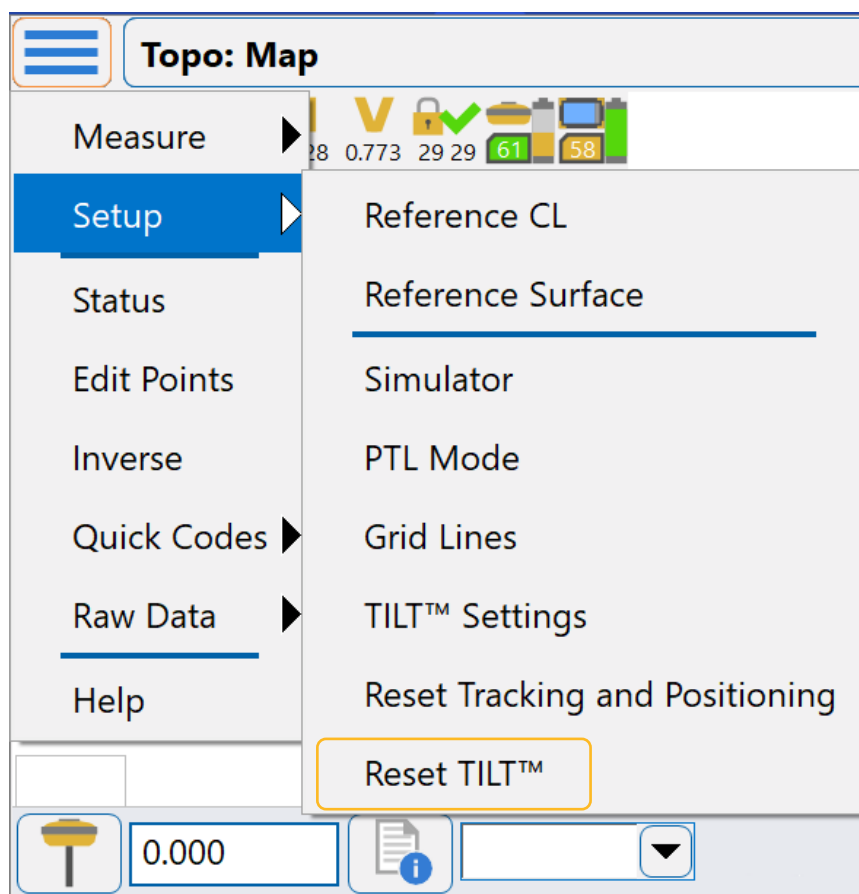



Figure 3-11: Topcon Field Setup Menu

IMU Alignment

It is necessary to do the IMU alignment procedure for TILT to enter a **Ready** state. The IMU alignment procedure automatically starts when TILT compensation mode is enabled. Text labels and icons show the Dynamic TILT state on the **TILT** screen.

The IMU alignment procedure moves TILT through these states:

- **Hold Still**  – TILT waits for a stable GNSS solution. When TILT has the solution, it is necessary to hold the pole stable and approximately vertical (precise vertical orientation is not required). TILT automatically senses the stable position and enters the **Move Pole** state

- **Move Pole**  – in this state, it is necessary to incline the pole, move it in a conical direction, then continue with a smooth conical pole movement until TILT enters the **Ready** state
- **Ready** – In this state, TILT can be used to make measurements.

 **NOTICE**

If TILT does not sense the initial incline move in the **Move Pole** state or this move is not sufficient, TILT goes to the **Hold Still** state and does the procedure again. This also occurs if the GNSS solution is lost while in the **Move Pole** state.



Figure 3-12: Conical Motion



Figure 3-13: TILT Move Pole State

Dynamic TILT Measurement

TILT always analyzes its quality during operation and can enter the **Move Pole** state again if the GNSS signal quality decreases. When the signal quality is normal and the movements in the **Move Pole** state are done again, TILT enters the **Ready** state.

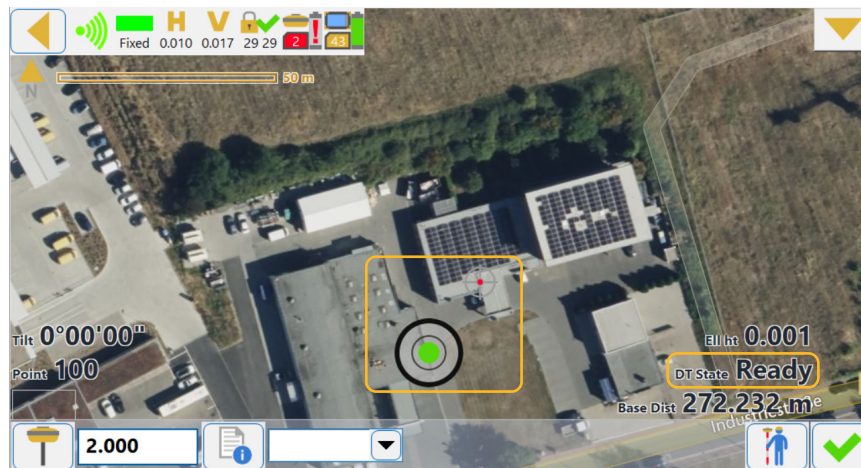

Figure 3-14: TILT Ready State

TILT monitors hits to the receiver and rotations. If the pole is hit or falls, TILT automatically resets. It is necessary to do the alignment procedure before measurements can be continued. It is also necessary to do the alignment procedure if the GNSS solution becomes unavailable for some seconds. In such cases, TILT cannot continue compensation.



NOTICE

TILT automatically resets after a significant hit or fast rotation. Best practice is to avoid even moderate hits and fast rotations to avoid decreased accuracy.

Other TILT States

- **Initialization** – initialization of TILT algorithms before operation
- **Ready (Reckoning)** – TILT senses no quality GNSS solution and waits for recovery, if the GNSS does not recover, TILT automatically resets, after which alignment must be done again
- **Error** – TILT must be manually reset
- **Disabled** – TILT is in Disabled mode
- **eLevel only** – TILT is in Electronic Level mode

TILT Electronic Level Operation

In **Filter** and **Disabled** operation modes, TILT simulates a pole level and shows a virtual bubble on the screen. In these modes, TILT does not compensate for pole inclinations and can be used only for vertical alignment. In **Filter** mode, TILT enters the **eLevel only** state independently of a GNSS solution and alignment procedures are not necessary. You can take very precise measurements in **Filter** and **Disabled** mode. In **Disabled** mode, electronic tilt correction and **Filter** mode are disabled, pole inclinations are measured and the inclination angle shows.

Electronic Level Setup

1. Open Topcon Field.
2. Open Topcon Field context menu, then select **Tilt Settings** to open the **TILT Settings** screen (Figure 3-16).

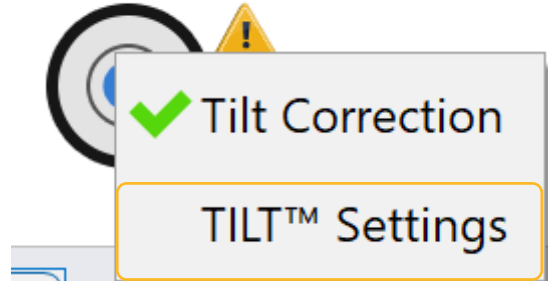

Figure 3-15: Topcon Field Context Menu

3. Select the **Show eLevel** checkbox.



NOTE

The virtual bubble shows on the screen (Figure 3-13 on page 3-15) when the **eLevel** checkbox is selected. The virtual bubble shows green when the pole inclination is within parameters. It shows red when the pole inclination is out of parameters.

4. Select the necessary radio button in the **Pole tilt handling** group.



NOTE

The filter value is an error threshold. When the actual inclination angle is within the threshold, it is possible to take measurements.

5. Select **Next**.

Figure 3-16: Filter Value

Factory Reset

A factory reset can be done two ways. The Power button (see “Power Button” on page 2-10) or the web UI can be used.

To do a factory reset of the GRX5 GNSS receiver parameters from the receiver web UI:

1. Connect the GRX5 GNSS receiver to a field controller or computer and open the on-board web UI (Figure 3-17 on page 3-18).
2. Open the **Management** menu, then select **Reset Receiver** to show the available reset options.
3. Select **FACTORY RESET**.

A dialog opens that shows information about the parameter reset.

4. Select **CONFIRM** to continue with the reset.

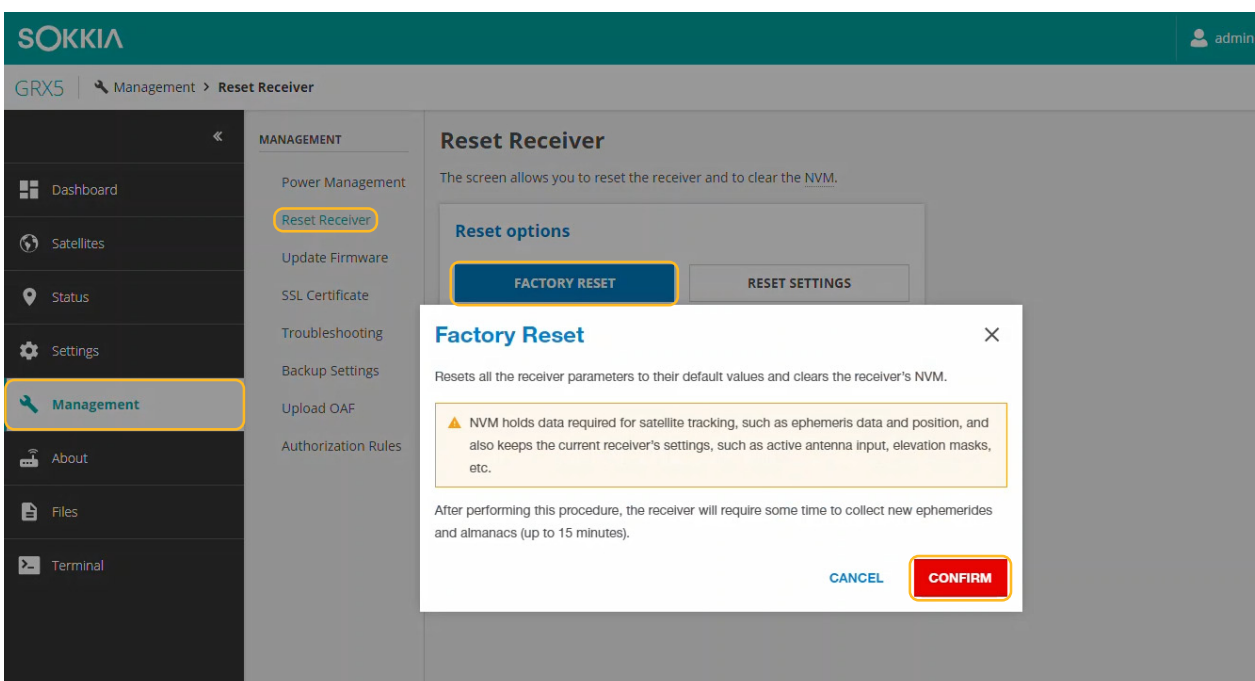

Figure 3-17: Factory Reset

Cleaning and Storing the Receiver

- Use a clean cloth moist with neutral detergent or water
- Do not use an abrasive cleaner, ether, thinner, benzene, or other solvents
- Make sure that the USB Type-C port is free of moisture before the battery packs are charged
- Always make sure that the receiver is fully dry before you store it
- Dry moisture with a soft, clean cloth.

Specifications

GRX5 GNSS Receiver

GNSS Receiver

Item	Specification
Channels	448 hardware channels to monitor all available satellites at the same time
Supported signals	GPS L1C/A, L1P, L2P, L2C, L5 GLONASS L1C/A, L2P, L2CA, L3 GALILEO E1, E5A, E5B, E5 AltBOC, E6 BEIDOU B1, B1C, B2, B2a, B2b, B3 QZSS L1C/A, L1 CB, L2C, L5 NavIC L5 SBAS L1, L5
SBAS	WAAS, EGNOS, GAGAN, MSAS, SDCM (L1, L5)
Signal integrity	GNSS interference monitoring and mitigation technology for anti-jamming and anti-spoofing Ionospheric scintillation monitoring and mitigation Multipath estimation and mitigation
Positioning update rate	10 Hz
Recording intervals	Selectable from 1 to 10 Hz
	OSNMA support
Tracking	20 dB-Hz
Acquisition	33 dB-Hz
RTK formats	RTCM 2.1, RTCM 2.3, RTCM 3.0, RTCM 3.1 RTCM 3.2 MSM3, RTCM 3.2 MSM4, RTCM 3.2 MSM5 CMR, CMR+

Positioning

Because of multipath anomalies, interference conditions and atypical satellite geometry. GNSS survey best practices must always be applied.

Item	Specification
Standalone/Autonomous	Horizontal 3.94 FT. (1.2 m) Vertical 5.9 ft. (1.8 M)
Code differential (SBAS)	Horizontal < 3.28 ft. (1.0 m) Vertical < 4.92 ft. (1.5 m)
DGNSS (RTCM Based)	Horizontal < 0.82 ft. (0.25 m) Vertical < 1.64 ft. (0.5 m)
Static and rapid static	Horizontal 0.01 ft. (3.0 mm) + 0.5 ppm (x baseline length) Vertical 0.016 ft. (5.0 mm) + 0.8 ppm (x baseline length)
High precision static	Horizontal 0.01 ft. (3.0 mm) + 0.1 ppm Vertical 0.011 ft. (3.5 mm) + 0.4 ppm

Item	Specification	
Real-time kinematic	Horizontal	0.016 ft. (5.0 mm) + 0.5 ppm (x baseline length)
	Vertical	0.033 ft. (10.0 mm) + 0.8 ppm (x baseline length) ^a
TILT compensation	Horizontal	RTK + 0.016 ft. (5.0 mm) + 0.002 ft. (0.5 mm)/degrees tilt (Up to 60 degrees)
Initialization	Cold start	< 45 seconds
	Warm Start	< 20 seconds
	Reacquisition	1 second
RTK time-to-first fix (TTFF)		< 10 seconds

a. Baseline < 24.9 mi (40 km)

Communications

Item	Specification	
Bluetooth	v5.3 BR/EDR and low energy long range	
LongLink	Up to 1148 ft. (350 m) range, with clear line of sight Supports up to three (3) simultaneous rover connections	
Wi-Fi	802.11a/b/g/n/ax 2.400 to 2.500 GHz Access point and Client modes	
Network	Integrated 4G/LTE cellular modem	
	FDD LTE bands	1, 2, 3, 4, 5, 7, 8, 12, 13, 18, 19, 20, 26, 28, 66
	TD LTE bands	38, 40, 41
	UMTS bands	1, 2, 3, 4, 5, 6, 8, 19
	Quad band GSM	850, 900, 1800, 1900 MHz

I/O Port

Item	Specification
USB	USB Type-C

Data Storage

Item	Specification
Memory storage	Internal, non-removable, 32 GB, 20 GB user-accessible ext4 file system format

Physical

Item	Specification
Dimensions (D x H)	0.45 ft. (138.6 mm) x 0.32 ft. (97.2 mm)
Weight	
Enclosure	Magnesium alloy and PC/PBT polymer
Color	Sokkia gray with blue bumper
GNSS Antenna	Integrated
Cellular Antenna	Integrated
Mounting	5/8-11 in. threaded socket
User Interface	Key 1x multi-function button for ON/OFF and REC
	LEDs 6x LEDs: PWR, STAT, BT, RADIO, REC, BATT
	Web UI On-board web user interface for firmware updates, managing receiver condition and settings, and data transfer

Environmental

Item	Specification
Operation temperatures	-4 °F (-20 °C) to + 122 °F (50 °C) (Battery power) -40 °F (-40 °C) to + 149 °F (65 °C) per MIL-STD 810G (with external power source)
Charge temperatures	32 °F (0 °C) to + 104 °F (40 °C)
Storage temperatures	-40 °F (-40 °C) to + 185 °F (85 °C)
Ingress protection	IP67
Humidity	100%
Vibration	Random: MIL-STD 202G, Method 214A Mechanical: Compliance with MIL-STD 810G-516.6
Shock	IEC 60068-2-27: Test Ea, 30 G at 9 ms duration, 3 shocks per polarity per axis, total 18
Drop	Survive 6.56 ft. (2 m) pole drop onto concrete surface Survive 3.28 (1 m) handle drop

Electrical

Item	Specification
Battery	Two internal, non-removable, Lithium-Ion battery packs each battery pack rated at 7.2 V, 3.5 Ah
External power input	USB Type-C power delivery (PD) 3.0 compatible 5/9/15/20 VDC 2 A
External power supply adapter rating	Output: USB Type-C power delivery (PD) 3.0 compatible, 5/9/15/20 VDC 2 A Input: 100 to 240 VAC 50 to 60 Hz, 1.5 A maximum

Item	Specification	
Power consumption	RTK BASE STATION with internal 1 W radio – 7 W RTK ROVER with internal radio – 5 W RTK ROVER (LongLink) – 3.5 W	
Power connector	USB Type-C	
Charge time	40 minutes to 50% charge when power is OFF 2.5 hours to 100% when power is OFF Ambient temperature 68 °F (20 °C)	
Operation time	STATIC (1 Hz data logging)	15 hours
	RTK ROVER (UHF)	10.5 hours
	RTK ROVER (LongLink)	13 hours
	RTK ROVER (Network)	11 hours
	RTK BASE STATION (1 W UHF)	7 hours
	RTK BASE STATION (LongLink)	13 hours
	RTK BASE STATION (Network)	11 hours

Radio Modules

The GRX5 GNSS receiver has optional hardware configurations. See Table 2-1; “GRX5 GNSS Receiver Assemblies, Part Numbers, and Descriptions,” on page 2-2 to identify which (if any) radio modem is installed.

Item	Specification																																			
SATEL TR4+	<p>SATEL-TR4+ is a UHF transceiver. Specific frequency bands are limited to certain regions and may not be available in all areas. Speak with a local Topcon dealer to learn what is locally available.</p> <ul style="list-style-type: none"> • Operating Frequency: 403 MHz to 473 MHz (licensed)* <ul style="list-style-type: none"> • Channel Spacing: 12.5/25 kHz • Carrier output power: User-selectable (10 mW to 1 W) • Sensitivity: -115 dBm BER 10E⁻² • Supported protocols and modulations: <table border="1" data-bbox="578 793 1477 1184"> <thead> <tr> <th data-bbox="578 793 878 827">Protocol:</th> <th colspan="2" data-bbox="878 793 1477 827">Modulation:</th> </tr> </thead> <tbody> <tr> <td data-bbox="578 827 878 861">RTCM SC135</td> <td colspan="2" data-bbox="878 827 1477 861">4FSK</td> </tr> <tr> <td data-bbox="578 861 878 894">SATEL-3AS</td> <td colspan="2" data-bbox="878 861 1477 894">4FSK</td> </tr> <tr> <td data-bbox="578 894 878 928">SATEL</td> <td colspan="2" data-bbox="878 894 1477 928">8FSK</td> </tr> <tr> <td data-bbox="578 928 878 961">SATEL</td> <td colspan="2" data-bbox="878 928 1477 961">16FSK</td> </tr> <tr> <td data-bbox="578 961 878 995">PDL</td> <td colspan="2" data-bbox="878 961 1477 995">4FSK</td> </tr> <tr> <td data-bbox="578 995 878 1029">PDL</td> <td colspan="2" data-bbox="878 995 1477 1029">GMSK</td> </tr> <tr> <td data-bbox="578 1029 878 1062">TrimTalk (P)</td> <td colspan="2" data-bbox="878 1029 1477 1062">GMSK</td> </tr> <tr> <td data-bbox="578 1062 878 1096">TrimTalk (T)</td> <td colspan="2" data-bbox="878 1062 1477 1096">GMSK</td> </tr> <tr> <td data-bbox="578 1096 878 1129">PacCrest FST</td> <td colspan="2" data-bbox="878 1096 1477 1129">4FSK</td> </tr> <tr> <td data-bbox="578 1129 878 1163">SOUTH</td> <td colspan="2" data-bbox="878 1129 1477 1163"></td> </tr> </tbody> </table> <p>*Regional UHF frequencies may be licensed or unlicensed, but are subject to restrictions within the 403 MHz to 473 MHz range. Failure to understand and apply this procedure may cause non-operation of the modem or breach of local regulatory laws.</p>			Protocol:	Modulation:		RTCM SC135	4FSK		SATEL-3AS	4FSK		SATEL	8FSK		SATEL	16FSK		PDL	4FSK		PDL	GMSK		TrimTalk (P)	GMSK		TrimTalk (T)	GMSK		PacCrest FST	4FSK		SOUTH		
Protocol:	Modulation:																																			
RTCM SC135	4FSK																																			
SATEL-3AS	4FSK																																			
SATEL	8FSK																																			
SATEL	16FSK																																			
PDL	4FSK																																			
PDL	GMSK																																			
TrimTalk (P)	GMSK																																			
TrimTalk (T)	GMSK																																			
PacCrest FST	4FSK																																			
SOUTH																																				
ALINCO XE9030EP (Japan only)	<p>XE9030EP is a wireless modem that satisfies both electrical and mechanical specifications required by the Technical Regulations Conformity Certification of Japan</p> <ul style="list-style-type: none"> • Operating Frequencies: 351.200000-351.38125 MHz <ul style="list-style-type: none"> • Channel Spacing: 6.25 kHz • User-selectable (500 mW to 1 W)* • Channels: 82 • Modulation: $\pi/4$Shift QPSK, 4FSK • Sensitivity: ≤ 0 dBuV (BER 1\times10⁻²) <table border="1" data-bbox="578 1755 1477 1906"> <thead> <tr> <th data-bbox="578 1755 878 1789">Modulation:</th> <th data-bbox="878 1755 1182 1789">bytes per second:</th> <th data-bbox="1182 1755 1477 1789">Transmit power:</th> </tr> </thead> <tbody> <tr> <td data-bbox="578 1789 878 1822">$\pi/4$Shift QPSK</td> <td data-bbox="878 1789 1182 1822">1024</td> <td data-bbox="1182 1789 1477 1822">100 mW to 500 mW</td> </tr> <tr> <td data-bbox="578 1822 878 1856">4FSK (512)</td> <td data-bbox="878 1822 1182 1856">4096</td> <td data-bbox="1182 1822 1477 1856">100 mW to 1W</td> </tr> <tr> <td data-bbox="578 1856 878 1890">4FSK (1024)</td> <td data-bbox="878 1856 1182 1890">4096</td> <td data-bbox="1182 1856 1477 1890">100 mW to 1W</td> </tr> </tbody> </table> <p>*Carrier output power of the Alinco XE9030EP is limited to a maximum of 500 mW for $\pi/4$Shift QPSK</p>			Modulation:	bytes per second:	Transmit power:	$\pi/4$ Shift QPSK	1024	100 mW to 500 mW	4FSK (512)	4096	100 mW to 1W	4FSK (1024)	4096	100 mW to 1W																					
Modulation:	bytes per second:	Transmit power:																																		
$\pi/4$ Shift QPSK	1024	100 mW to 500 mW																																		
4FSK (512)	4096	100 mW to 1W																																		
4FSK (1024)	4096	100 mW to 1W																																		

Troubleshooting

This chapter helps you to find the solutions to some problems that can occur during operation of the GRX5 integrated GNSS receiver. Problems and possible solutions are in tables.



CAUTION

Do not try to repair equipment. This voids the warranty and can cause damage to the hardware.

Do This First

Make sure that the most current firmware is loaded on the receiver (see “Firmware Update” on page 2-29). The current updates are available at <https://topconpositioning.com/support>.

1. Do a power cycle on the receiver (set the power to OFF and ON):
 - a. Push the **Power** button.
 - b. Hold the **Power** button for 3 to 10 seconds.
2. Clear the NVRAM and restore the default settings. See “Factory Reset” on page 3-18.

This restores the receiver’s parameters to the factory default settings and erases the almanac and ephemeris files. This procedure does not delete data files from the receiver memory.

Power Problems

The Receiver Power Does Not Go On

Cause	Solution
The internal battery pack can be fully discharged.	Connect the receiver to a sufficient power supply and charge the battery pack until the battery LED shows that the battery pack is fully charged. See “Battery Charging” on page 2-5.
The external power supply is not sufficient.	<ol style="list-style-type: none">1. Make sure that the charge level of an external battery/power supply is sufficient.2. Examine the fuse (if present).3. Make sure that the voltage and wattage of the external power supply is sufficient:<ul style="list-style-type: none">• USB-C PD 3.0 compatible, 5/9/15/20 VDC 2 A• 9 to 12 VDC with the USB Type-C to SAE accessory cable.
An external power cable is incorrectly connected.	<ul style="list-style-type: none">• Make sure that the cable is correctly connected.• Disconnect the cable from the receiver, then connect the cable to the receiver.• Make sure that the cable has no damage.

Cause	Solution
The power cable possibly has defects.	<ol style="list-style-type: none"> 1. Examine the cable and connectors for damage. 2. Make sure that the battery contacts are clean and do not have damage. 3. Make sure that no moisture is on the USB port and/or cable. 4. If possible, change the cable. 5. If possible, use a different power supply.

Receiver Problems

The Receiver Does Not Respond

Cause	Solution
A port conflict prevents a connection.	<ul style="list-style-type: none"> • Do a power cycle on the receiver (see Step 1 on page 5-1). • Reset the receiver parameters (see Table 2-4; “Power Button Functions,” on page 2-10). This process resets the GNSS related configuration and port settings. Network configurations are left as they were. This process does not erase recorded raw GNSS data, clear ephemeris, or clear Almanac data. • Do a Factory Reset (see Table 2-4: “Power Button Functions” on page 2-10) This process fully resets the receiver to factory defaults. All user configurations, GNSS ephemeris, and almanac are erased. Raw GNSS data that were recorded in the internal memory card are not erased. • If any of the above steps do not give a solution to the issue, an Emergency Shutdown can be tried (see Table 2-4; “Power Button Functions,” on page 2-10).
The receiver file system is corrupt.	Load the system firmware again (see “Firmware Update” on page 2-29).

The Receiver Does Not Track Satellites

Cause	Solution
The receiver has an blocked view of the sky.	Make sure that the receiver is outdoors and has a clear view of the sky.
The OAF (Option Authorization File) of the receiver is not applicable or expired. The STAT LED on the display panel flashes RED, the GREEN, then YELLOW.	Speak with a local Topcon dealer to get an applicable OAF for the receiver.

No Data Recorded

Cause	Solution
The internal memory of the receiver is full or the capacity is not sufficient.	<ol style="list-style-type: none"> 1. Connect to the web UI and delete expired files from the File Explorer. 2. Make sure to back up or move files that you want to keep.

No RTK Solution Obtained

Cause	Solution
The satellite geometry is unsatisfactory (the PDOP values are too high).	<ul style="list-style-type: none"> • Do the survey where satellite visibility is better (low PDOP value). • Make sure that the elevation mask is less than 10 degrees. • Increase the PDOP threshold. Select Receiver Settings > Tracking > Obs on the SRU main screen.
Incorrect base station coordinates are configured.	Enter the correct base station coordinates on the web UI, SRU or with different applicable field data collection software.
The base station does not operate.	Make sure that the power to the base station is set to ON and that it has sufficient power.
The base station and rover have different radio parameters.	<p>Make sure that the radio parameters are the same for the base station and rover:</p> <ul style="list-style-type: none"> • Channel / Frequency • Modulation • Protocol • Link Rate
Radio communications have interference.	<ul style="list-style-type: none"> • Change the RF channel (if possible). • Remove the source of the jammed signal or move the radio antennas (if possible).
There is a discrepancy between the differential corrections used by the base station and rover.	Make sure that the base station and rover receivers use the same GNSS corrections output/input format.
The radio antenna is incorrect.	Make sure that the radio antennas installed on the base station and rover receivers are correct for the radio and frequency band used for RTK correction (see Table 2-1.; “GRX5 GNSS Receiver Assemblies, Part Numbers, and Descriptions,” on page 2-2).
The distance between the base station and rover is too far.	<ul style="list-style-type: none"> • Decrease the distance between the base station and the rover. • Use repeaters to increase radio coverage.

Regulatory Information and Safety Warnings

General Warnings

1. Read and become familiar with the machine manufacturer's operator's manual, including safety information, before installing or using Topcon components.
2. Use extreme caution on the job site. Working around heavy construction equipment can be dangerous.
3. DO NOT attach Topcon brackets, cables, or hose connections while the machine is running.
4. DO NOT allow any Topcon components to limit the visibility of the operator.
5. Use cable ties to keep hoses and cables secured, and away from possible wear or pinch points.
6. Use eye protection when welding, cutting, or grinding on the machine.
7. Protect yourself at all times, and wear protective clothing when working on or near hydraulic lines. Hydraulic lines can be under extreme pressure, even when the machine is turned off.



DANGER

Relieve all pressure in the hydraulic lines before disconnecting or removing any lines, fittings, or related components. If injury occurs, seek medical assistance immediately.



CAUTION

When welding, use appropriate precautions and practices. After welding, all affected areas should be painted with a rust inhibitor.



DANGER

Disconnect all Topcon system electrical cables prior to welding on the machine.



DANGER

DO NOT weld near hydraulic lines or on any equipment when in operation.



CAUTION

All mounting bracket welds must be secure and strong to prevent the sensor equipment from vibrating excessively, or from detaching at the weld during operation.

This product should never be used:



CAUTION

- Without the operator thoroughly understanding the Operator's Manual and Quick Reference Guide.
 - After disabling safety systems or altering the product.
 - With unauthorized accessories.
 - Without proper safeguards at the job site.
 - Contrary to applicable laws, rules, and regulations.
-



WARNING

TPS products should never be used in dangerous environments. Use in rain or snow for a limited period is permitted.

**WARNING**

Tampering with the unit by the operator or non-factory authorized technicians will void the unit's warranty:

- Do not attempt to open the unit and modify any of its internal components.
- Do not short circuit.

Operation Requirement

A GRX5 base unit must be operated from a fixed location and can transmit and receive. A GRX5 rover can be mobile in operation as a receiver only.

RF Radiation Hazard Warning

**CAUTION**

To ensure compliance with FCC and Industry Canada RF exposure requirements, this device must be installed in a location where the antennas of the device will have a minimum distance of at least 42 cm from all persons. Using higher gain antennas and types of antennas not certified for use with this product is not allowed. The device shall not be located with another transmitter.

Installez l'appareil en veillant à conserver une distance d'au moins 42 cm entre les éléments rayonnants et les personnes. Cet avertissement de sécurité est conforme aux limites d'exposition définies par la norme CNR102 at relative aux fréquences radio.

**CAUTION**

This is a Class A product. In a domestic environment this product may cause radio interference in which case the user may be required to take adequate measures.

Regulatory Information

The following sections describe the FCC and ISED Canada statements.

FCC Statements

This equipment complies with FCC radiation exposure limits set forth for uncontrolled equipment and meets the FCC radio frequency (RF) Exposure Guidelines in Supplement C to OET65. This equipment has very low levels of RF energy that it deemed to comply without maximum permissive exposure evaluation (MPE). But it is desirable that it should be installed and operated with at least 42 cm and more between the antenna and person's body (excluding extremities: hands, wrists, feet and ankles).

This equipment has been tested and found to comply with the limits for a Class A digital device pursuant to part 15 of the FCC rules. These limits are designed to provide reasonable protection against harmful interference when the equipment is operated in a commercial environment. This equipment generates, uses, and can radiate radio frequency energy and, if not installed and used in accordance with the instruction manual, may cause harmful interference to radio communications. Operation of this equipment in a residential area is likely to cause harmful interference in which case the user will be required to correct the interference at his own expense.

If this equipment does cause interference to radio or television equipment reception, which can be determined by turning the equipment off and on, the user is encouraged to try to correct the interference by one or more of the following measures:

- Reorient or relocate the receiving antenna.
- Move the equipment away from the receiver.
- Plug the equipment into an outlet on a circuit different from that to which the receiver is powered.
- Consult the dealer or an experienced radio/television technician for additional suggestions.

ISED Canada Statements

This Class A digital apparatus complies with Canadian ICES-003.

The term "IC:" before the radio certification number only signifies that ISED technical specifications were met.

Under ISED Canada regulations, this radio transmitter may only operate using an antenna of a type and maximum (or lesser) gain approved for the transmitter by ISED Canada. To reduce potential radio interference to other users, the antenna type and its gain should be so chosen that the equivalent isotropically radiated power (EIRP) is not more than that necessary for successful communication. This device complies with ISED Canada license exempt RSS standard(s). Operation is subject to the following two conditions: (1) this device may not cause interference, and (2) this device must accept any interference, including interference that may cause undesired operation of the device. Under ISED Canada regulations, this radio transmitter may only operate using an antenna of a type and maximum (or lesser) gain approved for the transmitter by ISED Canada.

Déclaration de conformité IC

CAN ICES-3(A)/NMB-3(A)

Cet appareil numérique de la classe A est conforme à la norme NMB-003 du Canada.

Conformément à la réglementation d'ISED Canada, le présent émetteur radio peut fonctionner avec une antenne d'un type et d'un gain maximal (ou inférieur) approuvé pour l'émetteur par ISED Canada. Dans le but de réduire les risques de brouillage radioélectrique à l'intention des autres utilisateurs, il faut choisir le type d'antenne et son gain de sorte que la puissance isotrope rayonnée équivalente (PIRE) ne dépasse pas l'intensité nécessaire à l'établissement d'une communication satisfaisante. Ce matériel respecte les standards RSS exempt de licence d'ISED Canada. Son utilisation est soumise aux deux conditions suivantes: (1) l'appareil ne doit causer aucune interférence, et (2) l'appareil doit accepter toute interférence, quelle qu'elle soit, y compris les interférences susceptibles d'entraîner un fonctionnement non requis de l'appareil. Selon la réglementation d'ISED Canada, ce radio transmetteur ne peut utiliser qu'un seul type d'antenne et ne doit pas dépasser la limite de gain autorisée par ISED Canada pour les transmetteurs.

Product Conformity

Hereby, (Topcon) declares that (GRX5) is in compliance with the essential requirements and other relevant provisions of Radio Equipment Directive 2014/53/EC.

EU Declaration of Conformity (Radio Equipment Directive 2014/53/EU)

esky [Czech]	(Topcon) prohlašuje, že (GRX5) jsou v souladu s požadavky a dalšími příslušnými ustanoveními směrnice 2014/53/ES.
Dansk [Danish]	(Topcon) erklærer hermed, at (GRX5) er i overensstemmelse med kravene og andre relevante bestemmelser i direktiv 2014/53/EF.
Deutsch [German]	(Topcon) erklärt hiermit, dass (GRX5) mit den Anforderungen und anderen einschlägigen Bestimmungen der Richtlinie 2014/53/EG im Einklang steht.
Eesti [Estonian]	(Topcon) deklareerib käesolevaga, et (GRX5) on kooskõlas direktiivi 2014/53/EÜ nõuete ja muude asjakohaste sätetega.
English	(Topcon) hereby declares that (GRX5) are in accordance with requirements and other relevant provisions of Directive 2014/53/EC.
Español [Spanish]	(Topcon) declara que (GRX5) están de acuerdo con los requisitos y otras disposiciones pertinentes de la Directiva 2014/53/CE.
Ελληνικά [Greek]	(Topcon) δια του παρούσα δηλώνει ότι (GRX5) είναι σύμφωνα με τις απαιτήσεις και άλλες σχετικές διατάξεις της οδηγίας 2014/53/EK.
Français [French]	(Topcon) déclare par la présente que (GRX5) sont conformes aux exigences et autres dispositions pertinentes de la directive 2014/53/EC.
Italiano [Italian]	(Topcon) dichiara che (GRX5) sono conformi ai requisiti e ad altre disposizioni pertinenti del direttivo 2014/53/CE.
Latviski [Latvian]	(Topcon) ar šo deklarē, ka (GRX5) ir saskaņā ar prasībām un citiem attiecīgiem direktīvas 2014/53/EK noteikumiem.
Lietuvi [Lithuanian]	(Topcon) pareiškia, kad (GRX5) atitinka Direktyvos 2014/53/EB reikalavimus ir kitas atitinkamas nuostatas.
Nederlands [Dutch]	(Topcon) verklaart hierbij dat (GRX5) in overeenstemming zijn met de eisen en andere relevante bepalingen van Richtlijn 2014/53/EG.
Malti [Maltese]	(Topcon) b' dan tiddikjara li (GRX5) huma skont ir-rekwiżiti u dispożizzjonijiet rilevanti oħra tad-Direttiva 2014/53/KE.
Magyar [Hungarian]	(Topcon) kijelenti, hogy (a GRX5) összhangban van a 2014/53/EK irányelv követelményeivel és egyéb vonatkozó rendelkezéseivel.
Polski [Polish]	(Topcon) niniejszym oświadcza, że (GRX5) są zgodne z wymogami i innymi odpowiednimi przepisami dyrektywy 2014/53/WE.
Português [Portuguese]	(Topcon) declara que (GRX5) estão de acordo com os requisitos e outras disposições pertinentes da Diretiva 2014/53/CE.
Slovensko [Slovenian]	(Topcon) izjavlja, da so (GRX5) v skladu z zahtevami in drugimi ustreznimi določbami Direktive 2014/53/ES.

Slovensky [Slovak]	(TOPCON) týmto vyhlasuje, že (GRX5) sú v súlade s požiadavkami a inými relevantnými ustanoveniami smernice 2014/53/ES.
Suomi [Finnish]	(Topcon) vakuuttaa, että (GRX5) ovat direktiivin 2014/53/EY vaatimusten ja muiden asiaa koskevien säännösten mukaisia.
Svenska [Swedish]	(Topcon) förklarar härmed att (GRX5) är i enlighet med krav och andra relevanta bestämmelser i direktiv 2014/53/EG.

Appendix A-System Technology

This appendix describes the GRX5 GNSS receiver technology in more detail.

Station Marker Coordinates

A GNSS receiver does not find the coordinates of a station marker directly. It finds the coordinates of the GNSS antenna phase center.

Topcon Field or other post-processing applications use the antenna phase center coordinates and two user-specified parameters to calculate the station marker coordinates:

- Model of the receiver
- Measured height of the Antenna Reference Point (ARP) (5, Figure A-1) above the station marker

The antenna model and the received signal frequency position of the GNSS give the antenna phase center. Any Sokkia GNSS antenna has precise vertical offsets from the phase center to the ARP for the L1 and L2 frequencies (Figure A-1). After the application identifies the receiver model, it automatically takes the appropriate offsets from the built-in database and calculates the antenna reference point coordinates.

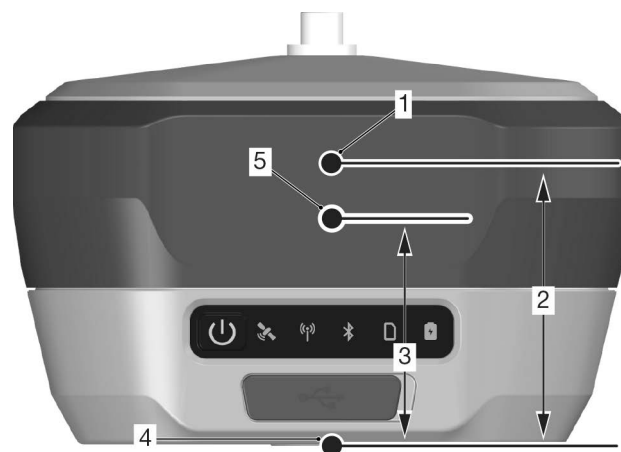

- | | | | |
|---|---------------------------------|---|-------------------------------|
| 1 | Antenna L2 phase center | 4 | Antenna Reference Point (ARP) |
| 2 | L2 phase center vertical offset | 5 | Antenna L1 phase center |
| 3 | L1 phase center vertical offset | | |

Figure A-1: GRX5 Antenna Phase Centers and ARP

The input of the measured height of the ARP above the station marker is necessary for field or post-processing applications to calculate the coordinates of the station marker.



NOTICE

The combination of the correct antenna phase center offsets and a reliable ARP height measurement method is necessary to accurately calculate the station marker coordinates of a given point.

Use a measuring tape and the vertical or slant measurement methods to find the height of the ARP above the station marker:

Base station (static) occupation	Use the slant measurement method for a tripod-mounted receiver. See “Receiver as Base Station Setup” on page 3-2.
Rover (kinematic) survey	Use the vertical measurement method for a pole-mounted receiver. See “Receiver as Rover Setup” on page 3-7.

USB Connections

Sokkia USB drivers for Microsoft Windows support all GRX5 receiver features that are available through a USB connection. They let a field controller or computer connect to the receiver through a Type-C USB data cable. See “Connection to a Computer Through USB” on page 2-16.

Topcon USB drivers set up a virtual COM port in Windows to supply a cabled connection to the GRX5 in the GNSS receiver mode. Select this port in the SRU and Topcon Field applications when you make a connection to the GRX5 with a USB Type-C data cable.

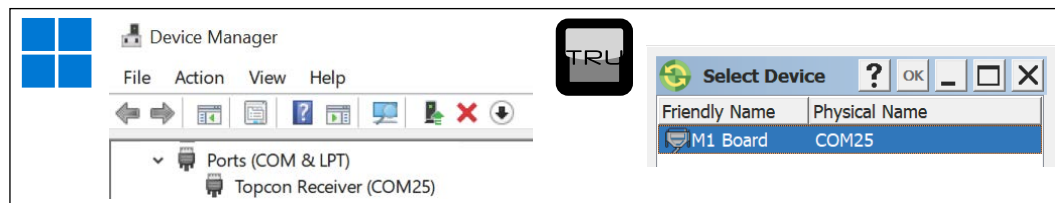

Figure A-2: Virtual COM Port in Windows and SRU

Glossary

B

BDS—BeiDou Navigation Satellite System maintained and operated by China. See also, BeiDou.

Base Station—A GNSS receiver set up over a known point, which is used to derive correction information for nearby Rover (mobile) GNSS receivers.

BeiDou—Navigation Satellite System maintained and operated by China. See also, BDS.

Bluetooth—Often used in place of cables, Bluetooth is open wireless technology for exchanging data over short distances from fixed and/or mobile devices.

E

Ephemeris Data—A table or data file showing the calculated positions of a celestial object.

G

GALILEO—The satellite system currently maintained and operated by the European Union (EU) and European Space Agency (ESA).

GGD—GPS + GLONASS Dual Frequency signal tracking.

GNSS—Global Navigation Satellite System.

GNSS Receiver—GNSS Receivers determine the user position, velocity and precise time by processing broadcasted signals from global satellites.

GLONASS—The **GLO**bal **NA**avigation **S**atellite **S**ystem maintained and operated by the Russian Federation.

GPS—The **G**lobal **P**ositioning **S**ystem maintained and operated by the United States Department of Defense.

L

L1—The primary L-band carrier used by GPS, GLONASS and QZSS satellites to transmit satellite data.

L2—The secondary L-band carrier used by GPS, GLONASS and QZSS satellites to transmit satellite data.

Light Emitting Diodes (LEDs)—These LEDs are used as indicator lights on the GRX5 receiver to show the condition of the receiver's components and to control receiver operations.

M

MINTER—The receiver's **M**inimum **I**NTERface used to display and control data input and output.

N

Network Real Time Kinematic (RTK)—a satellite navigation technique used to enhance the precision of position data derived from satellite-based positioning systems, for example, GPS, GLONASS, Galileo, BeiDou, QZSS, and NavIC systems.

O

Option Authorization File (OAF)— This enables the specific features that a customer purchases.

P

Phase Center of Antenna— The point from which the electromagnetic radiation spreads spherically outward, with the phase of the signal being equal at any point on the sphere.

Pocket 3D— Field controller software (made by Topcon) that supports both GNSS and Total Station measurements.

R

Real Time Kinematic (RTK)— A precise method of real-time surveying. RTK enables you to check the measurement quality without having to process the data.

Rover— A mobile GNSS receiver and data collector used for determining field location.

S

Satellite Based Augmentation Systems (SBAS)— SBAS transmits differential corrections and messages for navigation satellites that are within sight of a network or a reference station in a wide area— for example, a continent.

Static Survey— Typically uses a network or multiple baseline for positioning. The static survey method provides the highest accuracy and requires the longest observation times.

T

Topcon Field— Field application software used to collect survey mapping data for use by total stations, levels and GNSS receivers.

Topcon Office— Post-processing and CAD solution software for surveying and grade application. It is part of the Topcon software system.

Sokkia Receiver Utility (SRU)— Hardware configuration software designed for GNSS receivers and peripheral devices. SRU software is normally included on the GPS+ Software CD that accompanied your receiver.

U

Universal Serial Bus (USB)— An industry connection standard used by devices, for example, a receiver or controller to connect to a computer.

SOKKIA

Concerns regarding this Sokkia product may be sent to Service and Repair Department,
Topcon Positioning Systems, Inc., 7400 National Drive, Livermore, California 94550

Specifications subject to change without notice. All rights reserved.