

**SOKKIA**

**GP1X**  
**GP2X**  
**GP3X**  
**GP5X**

**Gyro Station**

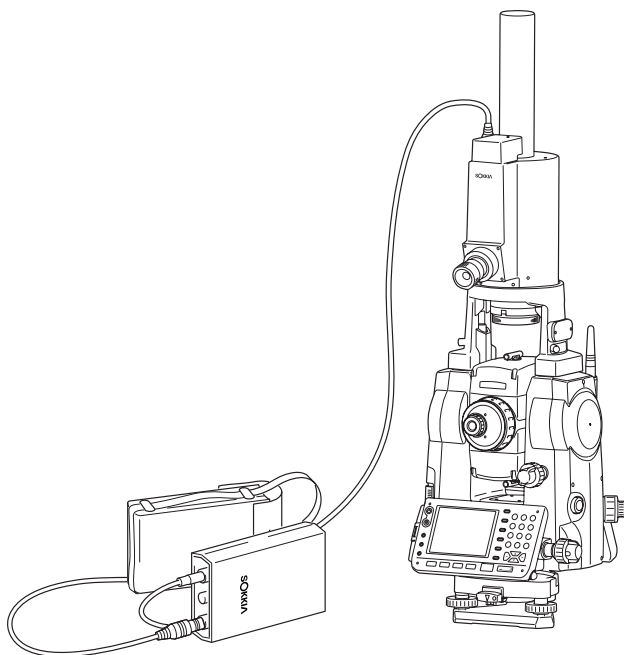

**CLASS 3R Laser Product**

**CLASS 1 LED Product**

**OPERATOR'S MANUAL**



Ni-MH

<b>[English]</b>	CONTAIN Ni-MH BATTERY. CADMIUM-FREE. MUST BE RECYCLED OR DISPOSED OF PROPERLY.
<b>[Deutsch]</b>	MIT NiMH AKKU. ENTHALT KEIN KADMIUM. EFORDERT RECYCLING ODER FACHGERECHTE ENTSORGUNG.
<b>[Français]</b>	CONTIENT UNE BATTERIE AU Ni-MH. SANS CADMIUM. DOIT ÊTRE RECYCLÉE OU DONNÉE A UN ORGANISME DE RETRAITEMENT.
<b>[Italiano]</b>	CONTIENE NiMH BATTERIA. NON CONTIENE CADMIO. DEVE QUINDI ESSERE RICICLATA O ELIMINATA IN MODO APPROPRIATO.
<b>[Nederlands]</b>	BEVAT EEN NiMH BATTERIJ. BEVAT GEEN CADMIUM. DIENT GERECYCLEERD OF OP EEN CORRECTE MANIER VERNIETIGD TE WORDEN.
<b>[Español]</b>	CONTIENE UNA NiMH BATERÍA. NO CONTIENE CADMIO. DEBE RECICLARSE O ELIMINARSE ADECUADAMENTE.
<b>[Portugulês]</b>	CONTEM BATERIA DE NiMH. SEM CÁDMIO. DEVERÁ SER RECICLADA OU DEPARTADA CONVENIENTEMENTE.
<b>[Svensk]</b>	INNEHÅLLER NiMH BATTERI. KÄDMIUMFRITT. BÖR ÅTERVINNAS ELLER FÖRSTÖRAS PÅ ETT SAKERT SÄTT.
<b>[Suomi]</b>	SISÄLTÄÄ NiMH AKUN. HÄVITETTÄESSÄ KÄSITELTÄVÄ ONGELMAJÄTTEENÄ.
<b>[Norsk]</b>	NiMH BATTERIER. INNEHOLDER IKKE KADMIUM. MÅ RESIRKULERES ELLER KASTES PÅ EN FORSVARLIG MÅTE.
<b>[Dansk]</b>	INDEHOLDER NiMH BATTERI. KADMIUMFRIT. SKAL GENVINDES ELLER KASSERES PÅ FORSVARLIG MÅDE.
<b>[Ελληνικά]</b>	ΠΕΡΙΕΧΕΙ ΜΠΑΤΑΡΙΑ ΝΙΚΕΛΙΟΥ-ΜΕΤΑΛΛΟΥ ΥΔΡΙΔΙΟΥ. ΔΕΝ ΠΕΡΙΕΧΕΙ ΚΑΔΜΙΟ. ΠΡΕΠΕΙ ΝΑ ΑΝΑΚΥΚΛΩΝΕΤΑΙ Η ΝΑ ΚΑΤΑΣΤΡΕΦΕΤΑΙ ΜΕ ΤΟΝ ΚΑΤΑΛΛΗΛΟ ΤΡΟΠΟ.

**For U.S.A. ATTENTION:**

The product that you have purchased contains a rechargeable battery. The battery is recyclable. At the end of its useful life, under various state and local laws, it may be illegal to dispose of this battery into the municipal waste stream. Check with your local solid waste officials for details in your area for recycling options or proper disposal. Use the standard battery charger.

**Die Schweiz:** Nach Gebrauch der Verkaufsstelle zurückgeben.

**La Suisse:** Après usage à rapporter au point de vente.

**Swizzera:** Ritornare la pila usate al negozio.

# SOKKIA

# GP1X GP2X GP3X GP5X

Gyro Station

CLASS 3R Laser Product

CLASS 1 LED Product



## OPERATOR'S MANUAL

- Thank you for selecting the GP1X/2X/3X/5X.
- Please read this operator's manual carefully before using this product.
- Verify that all equipment is included.  
☞ "15. STANDARD EQUIPMENT"
- The specifications and general appearance of the instrument are subject to change without prior notice and without obligation by Sokkia Topcon Co., Ltd. and may differ from those appearing in this manual.
- The content of this manual is subject to change without notice.
- Some of the diagrams shown in this manual may be simplified for easier understanding.

# HOW TO READ THIS MANUAL

## Regarding other manuals

---

- Manuals 3 and 4 below are electronic manuals provided on a CD-ROM in PDF format (  ). Adobe Reader is necessary in order to view these documents. The latest version of Acrobat Reader can be downloaded from the Adobe homepage.
- The GP1X/2X/3X/5X comes equipped with 4 manuals for operation information:
  1. GP1X/2X/3X/5X Operator's Manual (this manual):  
Explains gyro station use only.
  2. SETX Operator's Manual:  
Explains basic operation and functions of the SETX.
  3. Spectrum Survey Field Program Explanations (SETX)  :  
Explains advanced measurement operations using Spectrum Survey Field software.
  4. SFX Dial-Up Program Explanations (SETX)  :  
Explains how to send and receive data using the SFX function

## Symbols

---

The following conventions are used in this manual.



: Indicates precautions and important items which should be read before operations.



: Indicates the chapter title to refer to for additional information.



: Indicates supplementary explanation.



: Indicates an explanation for a particular term or operation.

**[Softkey]** etc. : Indicates softkeys on the display and window dialog buttons.

**{Key}** etc. : Indicates keys on the operation panel.

---

## Notes regarding manual style

---

- Except where stated, “SET” means “SET1X/2X/3X/5X” in this manual.
- Except where stated, “GPX” means “GP1X/2X/3X/5X” in this manual.

# CONTENTS

<b>1. PRECAUTIONS FOR SAFE OPERATION</b> .....	<b>1</b>
<b>2. PRECAUTIONS</b> .....	<b>5</b>
<b>3. LASER SAFETY INFORMATION</b> .....	<b>7</b>
<b>4. PARTS OF THE INSTRUMENT</b> .....	<b>9</b>
4.1 Gyro Station Features .....	9
4.2 Parts of the Instrument .....	10
4.3 Mode Structure .....	13
<b>5. BASIC OPERATION</b> .....	<b>14</b>
5.1 Basic Key Functions .....	14
<b>6. BATTERY CHARGING</b> .....	<b>17</b>
<b>7. PREPARATION FOR MEASUREMENT</b> .....	<b>19</b>
7.1 Connecting the Instruments .....	19
7.2 Preparing for Measurement with GP1 .....	21
7.3 Booting up and Quitting the Gyro Station Program .....	23
7.4 Finishing GP1 Measurement .....	25
<b>8. EXPLANATION OF MEASUREMENT MODES</b> .....	<b>26</b>
8.1 Selection of Measurement Mode .....	26
8.2 Azimuth Display Mode .....	27
<b>9. FOLLOW-UP MEASUREMENT</b> .....	<b>28</b>
<b>10. TIME MEASUREMENT</b> .....	<b>33</b>
<b>11. INSTRUMENT CONSTANT MEASUREMENT</b> .....	<b>38</b>
<b>12. ERROR MESSAGES</b> .....	<b>45</b>
<b>13. TROUBLE SHOOTING</b> .....	<b>46</b>
13.1 Replacing the Fuse .....	47
13.2 Replacing the Light Bulb .....	48
<b>14. CHECKS AND ADJUSTMENTS</b> .....	<b>49</b>

# CONTENTS

14.1 Checking the Suspension Tape . . . . .	50
14.2 Zero Point Adjustment . . . . .	50
14.3 Reticle Adjustment . . . . .	51
<b>15. STANDARD EQUIPMENT . . . . .</b>	<b>54</b>
<b>16. SPECIFICATIONS . . . . .</b>	<b>57</b>
<b>17. REGULATIONS . . . . .</b>	<b>59</b>
<b>18. APPENDIX : PRINCIPLE OF THE GP1 . . . . .</b>	<b>60</b>





# 1. PRECAUTIONS FOR SAFE OPERATION

For the safe use of the product and prevention of injury to operators and other persons as well as prevention of property damage, items which should be observed are indicated by an exclamation point within a triangle used with WARNING and CAUTION statements in this operator's manual.

The definitions of the indications are listed below. Be sure you understand them before reading the manual's main text.

## Definition of Indication



### WARNING

Ignoring this indication and making an operation error could possibly result in death or serious injury to the operator.



### CAUTION

Ignoring this indication and making an operation error could possibly result in personal injury or property damage.



This symbol indicates items for which caution (hazard warnings inclusive) is urged. Specific details are printed in or near the symbol.



This symbol indicates items which are prohibited. Specific details are printed in or near the symbol.



This symbol indicates items which must always be performed. Specific details are printed in or near the symbol.







## 1. PRECAUTIONS FOR SAFE OPERATION

---





### General

---

#### **Warning**

-  Do not use the unit in areas exposed to high amounts of dust or ash, in areas where there is inadequate ventilation, or near combustible materials. An explosion could occur.
-  Do not perform disassembly or rebuilding. Fire, electric shock, burns or hazardous radiation exposure could result.
-  Never look at the sun through the telescope. Loss of eyesight could result.
-  Do not look at reflected sunlight from a prism or other reflecting object through the telescope. Loss of eyesight could result.
-  Direct viewing of the sun using the telescope during sun observation will cause loss of eyesight. Use solar filter (option) for sun observation.
-  When securing the instrument in the carrying case make sure that all catches, including the side catches, are closed. Failure to do so could result in the instrument falling out while being carried, causing injury.











#### **Caution**

-  Do not use the carrying case as a footstool. The case is slippery and unstable so a person could slip and fall off it.
-  Do not place the instrument in a case with a damaged catch, belt or handle. The case or instrument could be dropped and cause injury.
-  Do not wield or throw the plumb bob. A person could be injured if struck.
-  Secure handle to main unit with locking screws. Failure to properly secure the handle could result in the unit falling off while being carried, causing injury.
-  Tighten the adjustment tribrach clamp securely. Failure to properly secure the clamp could result in the tribrach falling off while being carried, causing injury.

### Power Supply

---

#### **Warning**

-  Do not short circuit. Heat or ignition could result.
-  Do not place articles such as clothing on the battery charger while charging batteries. Sparks could be induced, leading to fire.
-  Do not use voltage other than the specified power supply voltage. Fire or electrical shock could result.
-  Do not use damaged power cords, plugs or loose outlets. Fire or electric shock could result.
-  Do not use power cords other than those designated. Fire could result.
-  Use only the specified battery charger to recharge batteries. Other chargers may be of different voltage rating or polarity, causing sparking which could lead to fire or burns.
-  Do not use the battery or charger for any other equipment or purpose. Fire or burns caused by ignition could result.
-  Do not heat or throw batteries into fire. An explosion could occur, resulting in injury.
-  To prevent shorting of the battery in storage, apply insulating tape or equivalent to the terminals. Otherwise shorting could occur resulting in fire or burns.
-  Do not use batteries or the battery charger if wet. Resultant shorting could lead to fire or burns.
-  Do not connect or disconnect power supply plugs with wet hands. Electric shock could result.

#### **Caution**

-  Do not touch liquid leaking from batteries. Harmful chemicals could cause burns or blisters.





## 1. PRECAUTIONS FOR SAFE OPERATION

---

### Tripod

---

#### **Caution**

-  When mounting the instrument to the tripod, tighten the centering screw securely. Failure to tighten the screw properly could result in the instrument falling off the tripod, causing injury.
-  Tighten securely the leg fixing screws of the tripod on which the instrument is mounted. Failure to tighten the screws could result in the tripod collapsing, causing injury.
-  Do not carry the tripod with the tripod shoes pointed at other persons. A person could be injured if struck by the tripod shoes.
-  Keep hands and feet away from the tripod shoes when fixing the tripod in the ground. A hand or foot stab wound could result.
-  Tighten the leg fixing screws securely before carrying the tripod. Failure to tighten the screws could lead to the tripod legs extending, causing injury.

### Remote Trigger (DLC1)

---

#### **Caution**

-  Do not leave batteries within reach of small children. If swallowed, consult a physician immediately.

## 2. PRECAUTIONS



- Please ensure that you are fully familiar with the SETX instrument and operator's manual before using this manual.

### Using the GP1

---

- Never place the GPX directly on the ground. Sand or dust may cause damage to the screw holes or the centering screw on the base plate.
- Protect the GPX from heavy shocks or vibration.
- As the battery capacity is limited to about 4 hours for continuous measurement, it is advised that all the measurements at the same survey station are performed without switching the power off. (The running-up of the gyro uses a large amount of battery power.)
- Charge the battery after measurements, using the charger CDC75.
- Ensure that the gyromotor is fully clamped before switching on or off the GP1. (The suspension tape seldom breaks when the correct clamping procedure is followed.)

#### "7.4 Finishing GP1 Measurement"

- When removing the battery from the GP1, make sure that the gyromotor is fully clamped, and the power switched off.
- When storing the GP1, make sure that the gyromotor is fully clamped and put the clamp lock over the clamping ring.



### Precautions concerning water and dust resistance

---

Remote trigger (DLC1) conforms to IP66 specifications for waterproofing and dust resistance when the battery cover is closed.

 For SETX waterproofing and dust resistance, see SETX operator's manual

- Make sure that moisture or dust particles do not come in contact with the inside of the battery cover, terminals or connectors.  
Ingress of moisture or dust into internal parts may cause damage to the instrument.
- Make sure that the inside of the carrying case and the instrument are dry before closing the case. If moisture is trapped inside the case, it may cause the instrument to rust.

## 2. PRECAUTIONS

---

### Maintenance

---

- The gyromotor should be overhauled three years after the purchase date, or after 3000 hours of use, whichever occurs sooner.
- Always clean the instrument before returning it to the case. The lens requires special care. First, dust it off with the lens brush to remove tiny particles. Then, after providing a little condensation by breathing on the lens, wipe it with the wiping cloth.
- Store the GPX in a dry room where the temperature remains fairly constant.
- If any trouble is found on the rotatable portion, screws or optical parts (e.g. lens), contact your local dealer.
- When the instrument is not used for a long time, check it at least once every 3 months.

#### "14. CHECKS AND ADJUSTMENTS"

- When removing the instrument from the carrying case, never pull it out by force. The empty carrying case should be closed to protect it from moisture.

### Exceptions from responsibility

---

- The user of this product is expected to follow all operating instructions and make periodic checks (hardware only) of the product's performance.
- The manufacturer, or its representatives, assumes no responsibility for results of faulty or intentional usage or misuse including any direct, indirect, consequential damage, or loss of profits.
- The manufacturer, or its representatives, assumes no responsibility for consequential damage, or loss of profits due to any natural disaster, (earthquake, storms, floods etc.), fire, accident, or an act of a third party and/or usage under unusual conditions.
- The manufacturer, or its representatives, assumes no responsibility for any damage (change of data, loss of data, loss of profits, an interruption of business etc.) caused by use of the product or an unusable product.
- The manufacturer, or its representatives, assumes no responsibility for any damage, and loss of profits caused by usage different to that explained in the operator's manual.
- The manufacturer, or its representatives, assumes no responsibility for damage caused by incorrect operation, or action resulting from connecting to other products.

### 3. LASER SAFETY INFORMATION

GPX is classified as the following class of Laser Product and LED Product according to IEC Standard Publication 60825-1 Ed. 2.0:2007 and United States Government Code of Federal Regulation FDA CDRH 21CFR Part 1040.10 and 1040.11 (Complies with FDA performance standards for laser products except for deviations pursuant to Laser Notice No.50, dated June 24, 2007.)

- EDM device in objective lens: Class 3R Laser Product  
(When using prism or reflective sheet as target or when in Auto Tracking mode) Class 1 Laser Product
- Auto pointing device in objective lens: Class 1 Laser Product
- Guide light: Class 1 LED product



- EDM device is classified as Class 3R Laser Product, however the equivalent of class 2 output is emitted only when reflectorless measurement is selected. When the prism and reflective sheet is selected in Config mode as target, the output is equivalent to the safer class 1.

#### Warning

- Use of controls or adjustments or performance of procedures other than those specified herein may result in hazardous radiation exposure.
- Follow the safety instructions on the labels attached to the instrument as well as in this manual to ensure safe use of this laser and LED product. The position of these labels are described in the SETX operator's manual.
- Never point the laser beam at another person. If the laser beam strikes skin or an eye, it could cause serious injury.
- Do not look directly into the laser beam source. Doing so could cause permanent eye damage.
- Do not stare at the laser beam. Doing so could cause permanent eye damage.
- If an eye injury is caused by exposure to the laser beam, seek immediate medical attention from a licensed ophthalmologist.
- Never look at the laser beam through a telescope, binoculars or other optical instruments. Doing so could cause permanent eye damage.
- Sight the targets so that laser beam does not stray from them.

#### Caution

- Perform checks at start of work and periodic checks and adjustments with the laser beam emitted under normal conditions.
- When the instrument is not being used, turn off the power.
- When disposing of the instrument, destroy the battery connector so that the laser beam cannot be emitted.

### 3. LASER SAFETY INFORMATION

---

- Operate the instrument with due caution to avoid injuries that may be caused by the laser beam unintentionally striking a person in the eye. Avoid setting the instrument at heights at which the path of the laser beam may strike pedestrians or drivers at head height.
- Never point the laser beam at mirrors, windows or surfaces that are highly reflective. The reflected laser beam could cause serious injury.
- Only those who have received training as per the following items shall use this product.
  - Read the Operator's manual for usage procedures for this product.
  - Hazardous protection procedures (read this chapter).
  - Requisite protective gear (read this chapter).
  - Accident reporting procedures (stipulate procedures beforehand for transporting the injured and contacting physicians in case there are laser induced injuries).
- Areas in which the lasers are used should be posted with laser warning notices.
- Persons working within the range of the laser beam are advised to wear eye protection which corresponds to the laser wavelength of the instrument being used.
- When using the laser-pointer function, be sure to turn OFF the output laser after distance measurement is completed. Even if distance measurement is canceled, the laser-pointer function is still operating and the laser beam continues to be emitted.
- The LED beam is emitted when the guide light is set to ON and the power is turned ON. Before turning ON the power check that there are no persons in the LED beam path. Alternatively, always set the guide light to OFF when you have finished measurement.



## 4. PARTS OF THE INSTRUMENT

### 4.1 Gyro Station Features

Gyro station GPX is a system for measuring true north using a combination of the GP1 gyroscope and SETX total station.

- The GP1 gyroscope unit uses a suspended gyromotor which oscillates around the earth's meridian (true north) due to the principle of precession caused by the rotation of the earth.

☞ "18. APPENDIX : PRINCIPLE OF THE GP1".

- The combination of the GP1 gyroscope and the SETX total station with special application software programs allows the true north position to be calculated by the SETX instrument.
- Two different measurement methods (follow-up or time measurement) can be used to determine the true north position. The true north measurement can be performed regardless of the magnetic conditions to a mean accuracy of  $\pm 20''$  (0.006 gon/0.10 mil).

☞ "8. EXPLANATION OF MEASUREMENT MODES".

- The calculated true north position can be easily transferred to the SET horizontal circle.

## 4. PARTS OF THE INSTRUMENT

### 4.2 Parts of the Instrument

☞ For parts of the SETX, see SETX operator's manual

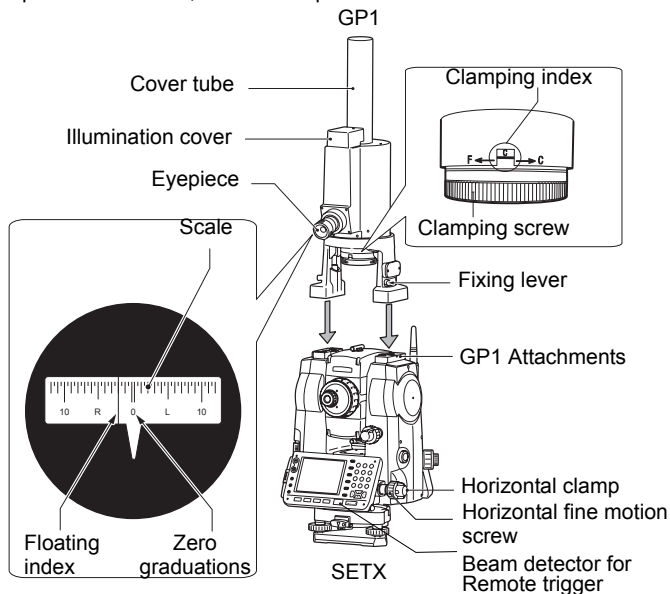

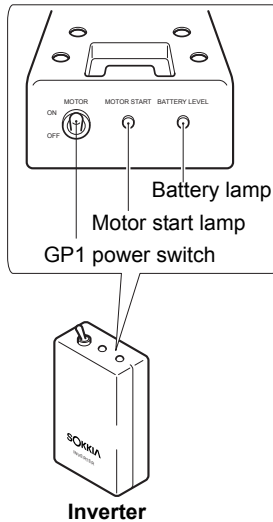

► SET operation panel

☞ "5.1 Basic Key Functions"

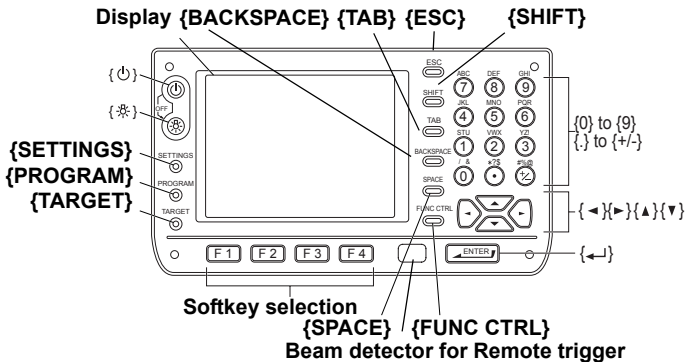

## 4. PARTS OF THE INSTRUMENT

---

### ► Remote trigger (DLC1)

---

The DLC1 allows remote key operation.

 "5.1 Basic Key Functions"

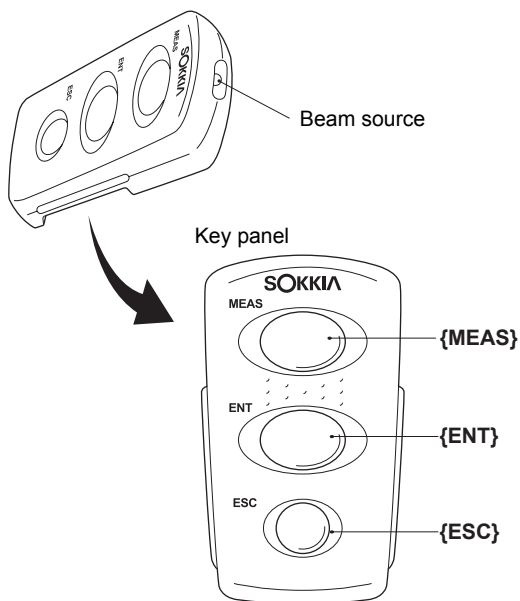

## 4.3 Mode Structure

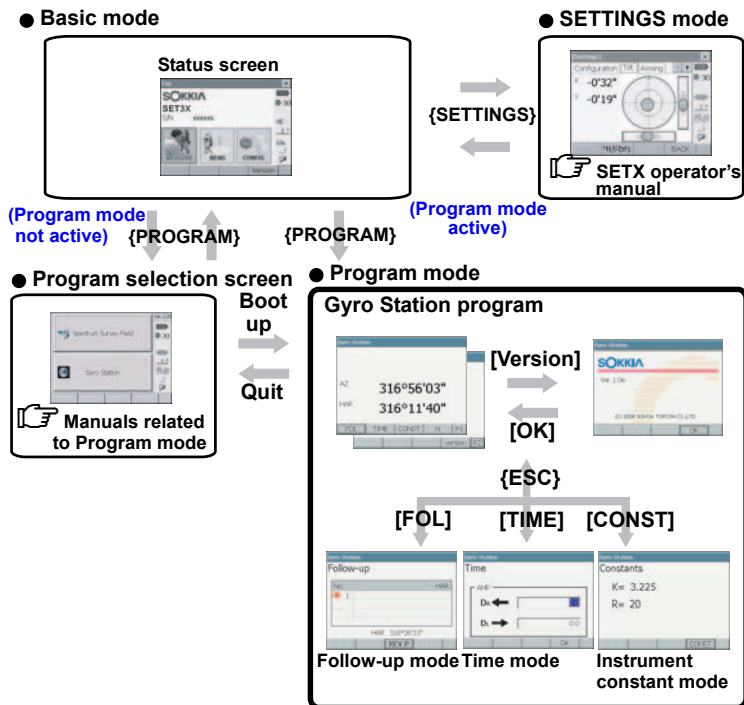



## 5. BASIC OPERATION

### 5.1 Basic Key Functions

 For the SET operation panel and Remote trigger key layout, see "4.2 Parts of the Instrument", for other key operations for the SET, see the SETX operator's manual

#### ● Power ON/OFF

{  }	Power ON
{  } (while pressing) + {  }	Power OFF

#### ● Switching to Program mode

{PROGRAM}	Switches from Basic mode to Program mode
-----------	--

#### ● Gyro Station program key functions

##### ● Azimuth display mode

[N]	Transfer the measured azimuth angle (the angle from calculated true north) to the original horizontal angle value.
{ESC}	Return to the Status screen.
[FOL]	Enter the Follow-up measurement mode.
[TIME]	Enter the Time measurement mode.
[CONST]	Enter the Instrument constants measurement mode.

##### ● Follow-up measurement mode

[REV.P]	Enter the reversing (turning) point position.
[OK]	End the Follow-up measurement, compute the true north position and exit to the Azimuth display mode.
[CE]	Delete the last turning point value.
{ESC}	Cancel the Follow-up measurement. Azimuth angle will not be calculated.

##### ● Time measurement mode

[EPOCH]	Enter the Time that the floating index mark crosses the zero graduations of the gyro scale.
{▶}	Select L (which side of zero the floating index is).
{◀}	Select R (which side of zero the floating index is).
[AMP]	Enter DR or DL (amplitude of the R and L turning points).
[OK]	End the Time measurement, compute the true north position and exit to the Azimuth display mode.

[CE]	Delete the last input of the [EPOCH] (i.e. if the [EPOCH] has been pressed too early or late), and restart the Time measurement procedure.
{ESC}	Cancel the Time measurement. Azimuth angle will not be calculated.

● Instrument constants measurement mode

[EPOCH]	Enter the time that the floating index mark crosses the zero graduations of the gyro scale.
{▶}	Select L (which side of zero the floating index is).
{◀}	Select R (which side of zero the floating index is).
[AMP]	Enter DR or DL (amplitude of the R and L turning points).
{ESC}	Cancel the Instrument constants measurement. Instrument constants will not be calculated.
[CE]	Delete the last input of the [EPOCH] (i.e. if the [EPOCH] has been pressed too early or late), and restart the Instrument constants measurement procedure.
[REC]	Memorize the constant obtained by the measurement in SET, end the Instrument constant measurement and exit to the Azimuth display mode.

## 5. BASIC OPERATION

---

### Key operation for Remote trigger (DLC1)

---

The GPX is operated from the Remote trigger by pointing the Remote trigger beam at the SET and pressing the required operation keys.

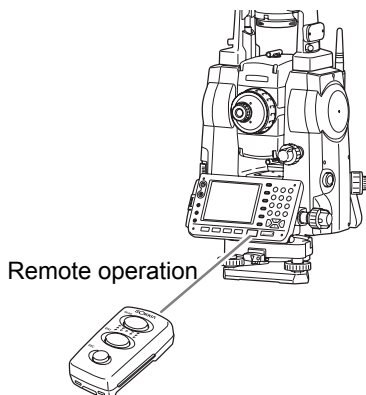

- When sunlight or the inverter lamp shines directly into the Beam Detector on the SET, remote operation with the Remote trigger may not work correctly.
- If other DLC1-compatible SOKKIA instruments are turned ON and placed within the operating range of the Remote trigger, they may be unintentionally operated at the same time.
- Do not place the keyboard under heavy objects or in a tight space. A key may be continuously depressed and deplete battery power.
- Working duration shortens under low temperatures.

<b>{MEAS}</b>	Performs same operation as trigger key on the SET (softkey in bold type on the screen)
<b>{ENT}</b>	Same operation as <b>{←}</b> on SET
<b>{ESC}</b>	Same operation as <b>{ESC}</b> on SET



## 6. BATTERY CHARGING



- Disconnect the battery from the GP1 to charge it.
- Charge the battery at a temperature between 0 and 40°C. The higher the temperature, the longer the charging time will be.
- Cables should not be connected to both the CHG and DC12V receptacles simultaneously.
- The battery charger normally becomes warm while charging.
- Do not charge the same battery more than once in quick succession.
- Do not wet the battery charger.
- Disconnect from the wall outlet when not in use.
- Charge the battery once a month when not in use for long periods.
- Prevent short circuit by closing case flap when not charging.

### ► PROCEDURE

---

1. Plug the charger power plug into the wall outlet.
2. Open the BDC7A case flap and insert the cable attached to CDC75 into the DC12V receptacle on BDC7A. The yellow LED blinks slowly. Then after a short period, the green LED blinks and charging starts.
3. The green LED stops blinking and lights steadily when charging is complete. Charging time is about 9 hours.
4. When charging is complete, disconnect the charger cable from the battery and unplug the charger power plug from the wall outlet.

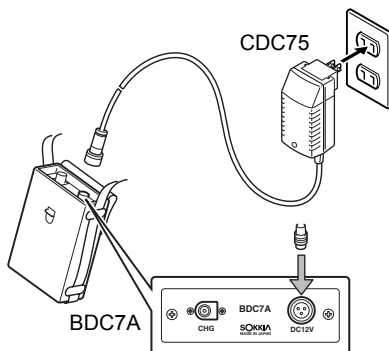

## 6. BATTERY CHARGING

---

- The following table describes the status of the yellow/green LEDs under various conditions.

Display on Main Unit	Status	Yellow LED	Green LED
Standby	Stand-by	ON	OFF
Pre Charge	Pre-charge check	Slow blink	OFF
Rapid Charge	Rapid Charge	OFF	Rapid blink
Maintain	Trickle Charge	OFF	Slow blink
Error	Battery may be faulty. Please contact your local dealer.	Rapid blink	OFF
Ready	Charging complete	OFF	ON
Wait	N/A		

# 7. PREPARATION AND FINISHING MEASUREMENT

This chapter will describe the preparations necessary for measurement as well as explaining how to finish measurement.

## 7.1 Connecting the Instruments

Connect the SET, GP1, inverter and battery as shown below.

5-pin cable

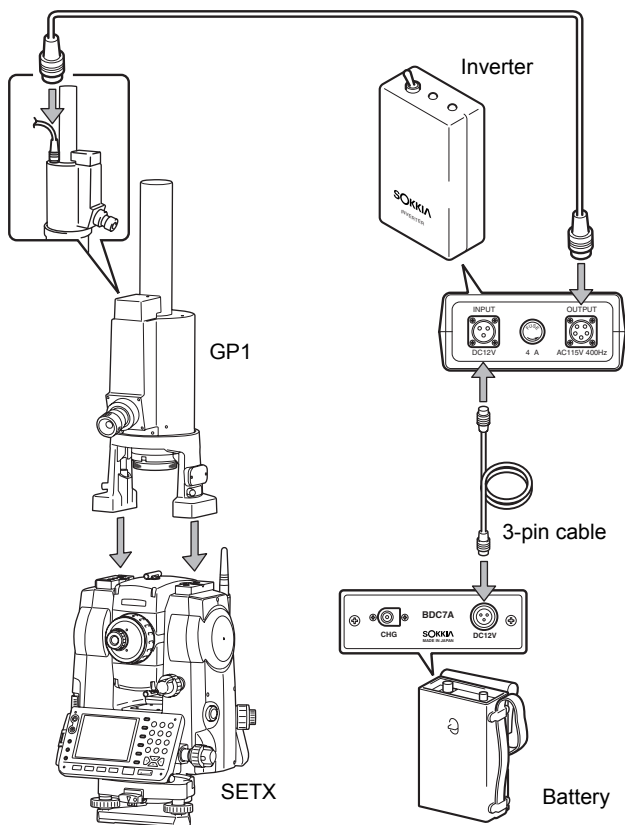

## 7. PREPARATION AND FINISHING MEASUREMENT

---

### ►PROCEDURE

---

1. Set up the tripod over the measurement point and mount the SET on the tripod.

 SETX operator's manual

2. Set the GP1 fixing levers to the open position. Lower the GP1 onto the SET and lock the fixing levers.

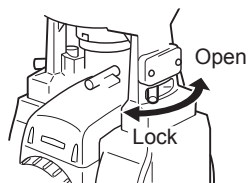

3. Connect the GP1 connector to the Inverter OUTPUT connector with the 5-pin cable.
4. Connect the Inverter INPUT connector to the battery DC 12V connector with the 3-pin cable.
5. Perform leveling as described in  SETX operator's manual

**7.2** Preparing for Measurement with GP1**► PROCEDURE**

1. Mount the tubular compass on the top of the GP1 and align the compass body with the SET telescope. Loosen the tubular compass clamping screw.

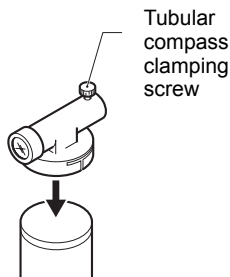

2. Use the horizontal clamp and horizontal fine motion screw to turn the SET until the tubular compass needle is centered between the S index lines. The SET is now pointing towards approximate magnetic north. Where the compass is not usable, use any other available means to point the SET telescope in the north direction; e.g. map, sun, time etc.

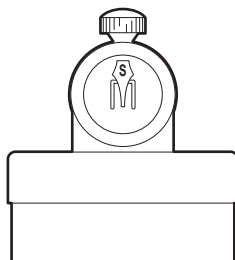

3. Do not turn on the gyromotor - check that the movement of the pendulum is symmetrical around the zero graduations using the following procedure.

## 7. PREPARATION AND FINISHING MEASUREMENT

---

- a. Turn the clamp screw fully in the C direction until the "C" mark can be seen in the clamping index. The pendulum is now fully clamped - **FULL CLAMP position**.

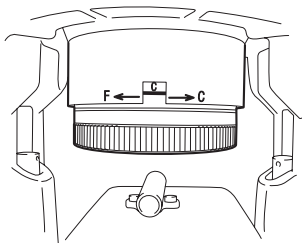

- b. Turn the clamp screw in the F direction until the "▼" mark can be seen in the clamping index. Continue turning in the F direction until the "▲HC" mark on the clamp screw is aligned with the "▼" mark in the clamping index. The pendulum is now only lightly clamped. This is the **HALF-CLAMP position**.

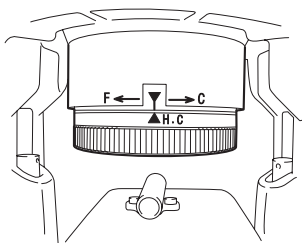

- c. Wait for approx. 10 seconds at this position to allow the pendulum movement to settle. Check the floating index movement.
- d. Now turn the clamp screw fully in the F direction. When the clamp can be turned no further in the F direction the **FREE position** has been reached. The pendulum is now freely suspended.
- e. Check that the floating index is moving symmetrically around the zero graduations. If the movement is not symmetrical,  "14.2 Zero Point Adjustment"

- f. Turn the clamp screw back in the C direction until the pendulum is in the FULL CLAMP position once again.
4. Switch on the GP1 power switch located on the inverter.



- When the battery power becomes low the battery lamp is lit red. Recharge the battery.

 "6. BATTERY CHARGING"

5. Approximately 60 seconds after turning on the power, the motor start lamp is lit green. This indicates that the gyromotor is rotating correctly.

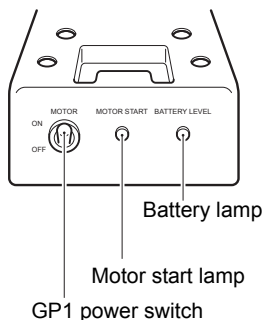

Preparation for measurement with the GP1 is complete.

### 7.3

## Booting up and Quitting the Gyro Station Program

### ►PROCEDURE Booting Up

1. Mount the battery.  
 SETX operator's manual
2. Press {⏻}. When the power is switched on, a self-check is run. The Status screen is displayed.

## 7. PREPARATION AND FINISHING MEASUREMENT

- Press **{PROGRAM}** in Basic mode to display the program selection screen. The program selection screen provides access to all programs in Program mode.

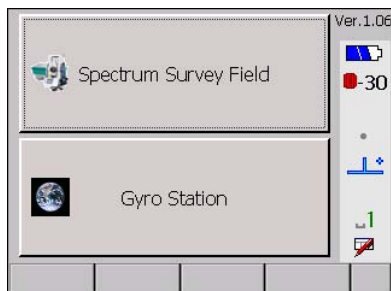

- Select "Gyro Station" in the screen of step 3. The screen shown at right is displayed.

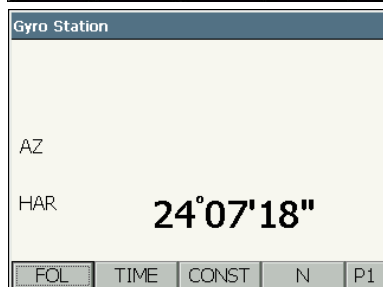

- Quit Gyro Station program, then press **{PROGRAM}** to return to Basic mode.

### ►PROCEDURE Quitting

- Press **{ESC}** to display the confirmation screen shown in step 2.
- Press **[YES]** to quit Gyro Station program.

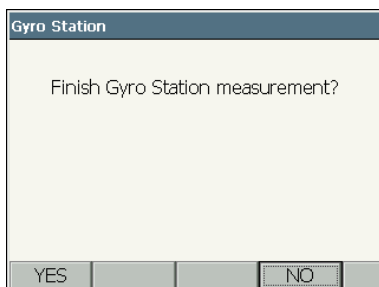





- Pressing **{PROGRAM}** after performing a warm boot will automatically restore the program active before the warm boot was performed.

### 7.4 Finishing GP1 Measurement

Always follow the procedure below to finish measurement. This procedure should also be performed when moving to a different point.

#### ► PROCEDURE

- Turn the clamp screw in the C direction until the pendulum is in the FULL CLAMP position.
- Check that the pendulum is in the FULL CLAMP position then turn off the power to the GP1 using the switch on the inverter.
- Wait for approx. 10 minutes for the motor to come to a complete standstill. Check that no sound is coming from the motor and put the clamp lock over the clamping screw, then store in the carrying case or move to the next point.

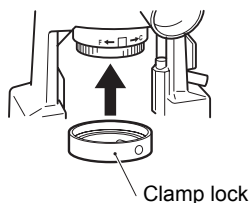
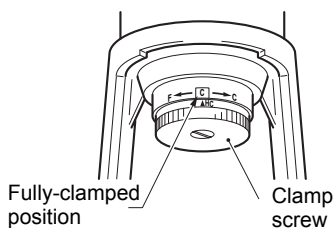

## 8. EXPLANATION OF MEASUREMENT MODES

This section will explain the selection of measurement mode and the Azimuth display which is displayed before and after the execution of true north measurement.

### 8.1 Selection of Measurement Mode

Both Follow-up (Turning point) measurement and Time measurement may be used to make a true north measurement.

**Follow-up measurement** (using 2 turning points) may be used to quickly obtain an approximate true north position. Repeat this measurement when the initial approximate alignment of the SET telescope with true north is not close to true north.

Follow-up measurement (using 3 or more turning points) can be used to determine an accurate true north position within 20" when the telescope can be roughly pointed to within  $\pm 2^\circ$  of true north before measurement.

☞ "9. FOLLOW-UP MEASUREMENT"

**Time measurement** can be used to determine an accurate true north position within 20" when the telescope can be roughly pointed to within  $\pm 20'$  of true north before measurement.

☞ "10. TIME MEASUREMENT"

Although the accuracy of both Follow-up measurement and Time measurement are the same when determining true north, the procedures are quite different. It is recommended that the results obtained by each mode be compared to check the accuracy of the measurements.

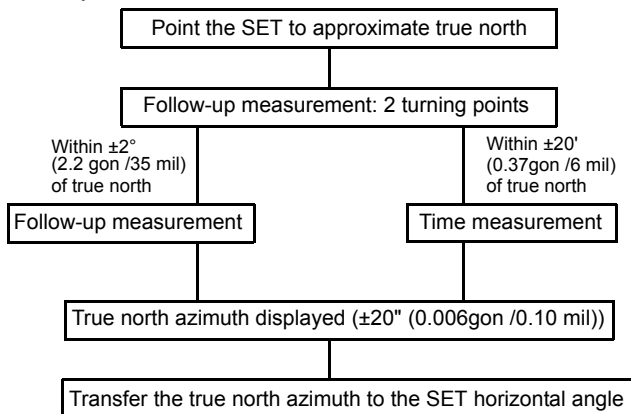

## 8.2 Azimuth Display

Azimuth angle is displayed in the Gyro Station program.

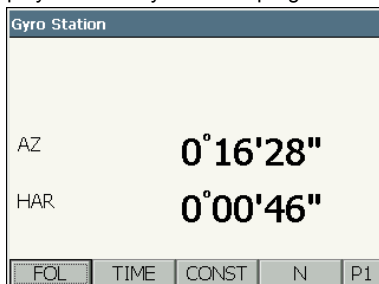

- The azimuth (angle from the calculated true north position) is displayed in AZ and the horizontal angle is displayed in HAR. The horizontal angle can be displayed as a clockwise/counterclockwise value whereas the azimuth can only be displayed as a clockwise value.
- Press **[N]** to transfer the azimuth angle to the horizontal angle. The azimuth angle is now displayed as a horizontal angle, even in Basic mode.
- To perform true north measurement, rotate the SET until the displayed AZ value (azimuth angle) is 0° 00' 00".  
 ☞ "9. FOLLOW-UP MEASUREMENT", "10. TIME MEASUREMENT"
- When the horizontal angle is set to 0 in the Instrument constants measurement mode the current azimuth angle settings cease to be in effect and the azimuth angle is no longer displayed. To display the azimuth angle, perform either Follow-up measurement or Time measurement.  
 ☞ "11. INSTRUMENT CONSTANT MEASUREMENT"

## 9. FOLLOW-UP MEASUREMENT

Follow-up measurement involves carefully rotating the SET to follow the movement of the floating index. When the floating index reaches its turning point, press **[REV.P]** to record the horizontal angle. When 2 or more successive turning points have been recorded, the true north direction can be determined. To improve the accuracy of true north determination, the SET telescope should be roughly pointed to within  $\pm 2^\circ$  of true north, and 3 or more successive turning points should be measured.



- Follow-up measurement involves rotation of the SET which can cause the pendulum to move. Such vibrations of the pendulum can adversely affect the accuracy of the results. Care must be taken to rotate the SET without disturbing the pendulum movement.



### Turning point

The turning point is the point at which the movement of the floating index switches  $R \rightarrow L$  or  $L \rightarrow R$ . As the index approaches the turning point it appears to slow down and stop, before changing direction.

The following is a method for following the floating index.

- Observe the movement of the index in the FREE position (Assuming that the index is starting from the 2nd graduation on the L side of zero and is moving in the R direction).
- Wait until the index comes to the 2nd graduation on the R side of zero.
- Rotate the SET using the horizontal clamp and horizontal fine motion screw until the index is at the opposite 2nd graduation on the L side.

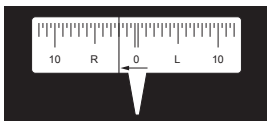
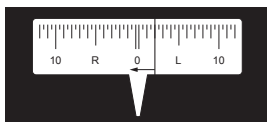

Rotate the SET

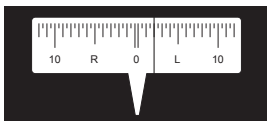

4. The index moves in the L → R direction once again. When the index movement slows repeat the procedure described in Steps 2 and 3 rotating the SET at smaller and smaller graduations, first 1 then 0.5 graduations.
5. The turning point has been reached when the index comes to a standstill in the zero graduations.

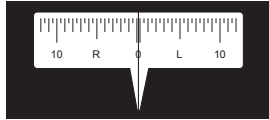

**Theory of the follow-up measurement**

Follow-up measurement computes true north as follows:

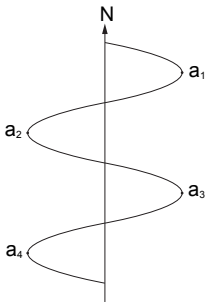

When the number of turning points is 2

:

$$N = \frac{a_1 + a_2}{2} + R$$

$a_1, a_2$ : turning points

N: true north

R: alignment constant

When the number of turning points is 3 or more:

$$N = \left( \frac{a_1 + a_3}{2} + a_2 + \frac{a_2 + a_4}{2} + a_3 + \dots + \frac{a_{n-2} + a_n}{2} + a_{n-1} \right) \cdot \frac{1}{n-2} + R$$

## 9. FOLLOW-UP MEASUREMENT

---

### ►PROCEDURE

---

1. Press [FOL] in the screen shown at right.



2. To prepare for measurement set the GP1 to the HALF-CLAMP position and wait approx. 10 seconds to allow the movement of the floating index to settle. Then, slowly open to the FREE position.



- If the floating index appears to make fine oscillations after turning the clamping screw to the FREE position, turn the clamp back halfway in the C direction. When these irregular movements have ceased release the clamp back to the FREE position.
- If the speed of the floating index appears to be too fast after turning the clamping screw to the FREE position, movements of 5 or 10 graduations may be necessary to follow it.

3. Press **[REV.P]** when the turning point is aligned with the zero graduations.
  - If a mistake is made when pressing **[REV.P]** at the turning point, **[CE]** can be used to delete the last input value. After deleting the last input value by pressing **[CE]**, continue measurement starting with the next turning point in the same direction (e.g. If **[CE]** is pressed at the turning point on the R side of zero, the next measurement should be the turning point on the R side of zero).

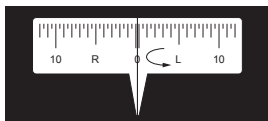

Gyro Station	
Follow-up	
No.	HAR
→ 1	
HAR 22°16'58"	
<b>[REV.P]</b>	

4. Input the turning point values for the turning point measured in Step 3 and the opposite turning point.

Gyro Station	
Follow-up	
No.	HAR
1	0°00'44"
→ 2	
HAR 0°00'43"	
<b>[CE]</b>	<b>[REV.P]</b>

5. Continue pressing **[REV.P]** until the required number of turning points have been measured. The minimum number is 2 and the maximum number is 10.

Gyro Station	
Follow-up	
No.	HAR
1	0°00'44"
2	0°32'10"
→ 3	
HAR 0°32'09"	
<b>[CE]</b>	<b>[REV.P]</b> <b>[OK]</b>

## 9. FOLLOW-UP MEASUREMENT

- Press **[OK]** to end follow-up measurement when input is complete. The true north position is calculated and the SET returns to the azimuth display screen. After the 10th turning point has been measured, the true north position is automatically calculated and the SET exits to the azimuth display screen.

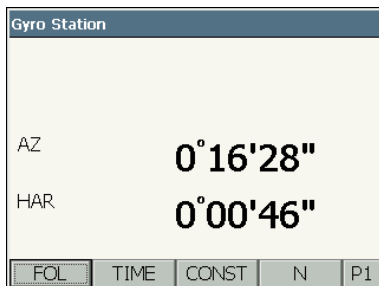

- The calculated azimuth angle can be set as the horizontal angle.

 "8.2 Azimuth Display"

- When switching to a different measurement mode, always set the GP1 to the FULL CLAMP position before starting measurement again. If all measurements have been completed, set the GP1 to the FULL CLAMP position then turn off the power.

 "7.4 Finishing GP1 Measurement"



# 10. TIME MEASUREMENT

Time measurement is performed without moving the SET instrument. By inputting the DR/DL values, i.e. the amplitude of the R and L turning points (position of the turning points on the graduated scale), and pressing a key each time the floating index crosses the zero graduations, it is possible to calculate a true north position.

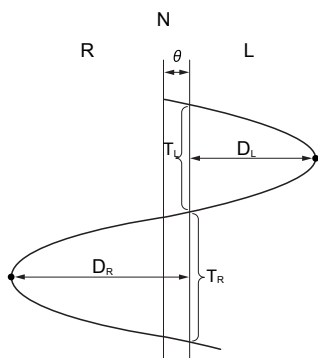

$$\theta = -(K \cdot D \cdot Dt + R)$$

K: Instrument constant

R: Alignment constant

$D = (DR + DL) / 2$ : Average of the R and L amplitude values.

$Dt = TR - TL$ : Time difference between successive zero crossings.



- Before starting Time measurement point the telescope approximately in the direction of true north to within  $\pm 20'$  using Follow-up measurement (2 turning points).  
[Hand icon] "9. FOLLOW-UP MEASUREMENT"
- For correct measurement, the index should have steady movement, and an R and L amplitude in the range of 8-10 graduations either side of 0. The amplitude of the index can be changed by first re-tightening the clamp to the FULL CLAMP position, then releasing again until the FREE position is reached once again.

## ► PROCEDURE

1. Perform Follow-up measurement (2 turning points).  
[Hand icon] "9. FOLLOW-UP MEASUREMENT"  
Determine true north to within  $\pm 20'$ . Point the telescope to Azimuth  $0^\circ 00' 00''$  in the Azimuth display mode.

## 10. TIME MEASUREMENT

- Press **[TIME]** in the Azimuth display mode to enter the Time measurement mode.

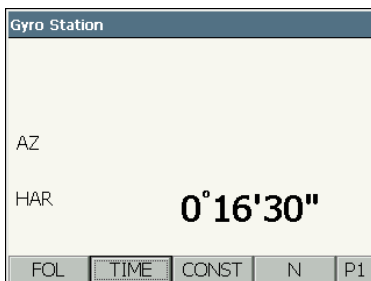

- Set the GP1 to the HALF-CLAMP position and wait approx. 10 seconds to allow the movement of the floating index to settle. Then, slowly open to the FREE position.



- If the floating index appears to make fine oscillations after turning the clamping screw to the FREE position, turn the clamp back halfway in the C direction. When these irregular movements have ceased release the clamp back to the FREE position.
- Observe the movement of the index.

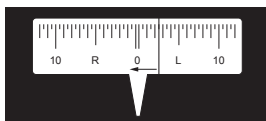

5. Read the position of the R/L-side turning point on the graduated scale to the nearest 0.1 units. Input this DR/DL value (amplitude) and press **[OK]**.

6. At the moment the floating index crosses the zero graduations, press **[EPOCH]**.

7. After the floating index has crossed the zero graduations input whether it is on the R or L side of the zero graduations. If it is on the R side of zero, press **[←]**. If it is on the L side of zero, press **[→]**. After inputting the direction, the relevant arrow symbol will be displayed.

- Incorrect input of **[←]** or **[→]** can be corrected by pressing the same key again.

## 10. TIME MEASUREMENT

8. At the moment the floating index crosses the zero graduations, press **[EPOCH]**.

The time (sec.) taken for this half-cycle is displayed in "Half cycle(sec)".

- Press **[AMP]** to change the amplitudes (DR and DL) input in Step 5.
- If a mistake is made when pressing **[EPOCH]** at the turning point, **[CE]** can be used to delete the last input value. After deleting the last input value by pressing **[CE]**, continue measurement starting with the next crossing of the zero graduations.

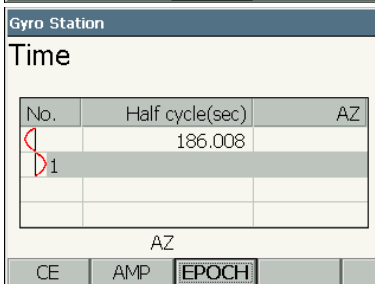
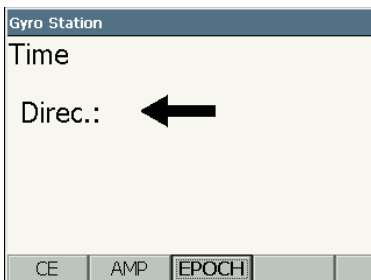

9. At the moment the floating index crosses the zero graduations, press **[EPOCH]**. The time (sec.) taken for this second half-cycle is displayed in "Half cycle(sec)". The calculated azimuth angle is displayed in AZ. After the input of the full cycle, an audio warning is given approximately 20 seconds before the floating index is due to cross the zero graduations.

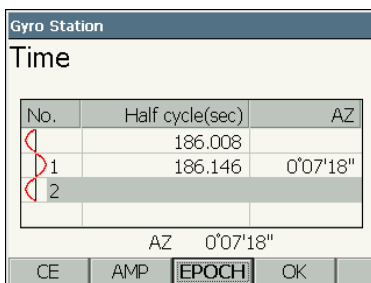

10. Continue to press **[EPOCH]** for the required number of crossings of the zero graduations. The maximum is 255.

Gyro Station		
Time		
No.	Half cycle(sec)	AZ
2	186.008	
3	186.146	0°07'18"
4	186.306	0°07'14"
5		
		AZ 0°07'16"
CE	AMP	<b>[EPOCH]</b> OK

11. Press **[OK]** to end Time measurement when input is complete. The true north position is calculated and the SET returns to the azimuth display mode. After the 255th value has been input, the true north position is automatically calculated and the SET exits to the azimuth display mode.

Gyro Station	
AZ	<b>0°07'16"</b>
HAR	<b>0°16'30"</b>
FOL	<b>[TIME]</b> CONST N P1

- The calculated azimuth angle can be set as the horizontal angle.

 "8.2 Azimuth Display"

12. When switching to a different measurement mode, always set fully clamp the gyrometer before starting measurement again.

If all measurements have been completed, make sure that the gyromotor is fully clamped, then turn off the power.

 "7.4 Finishing GP1 Measurement"

# 11. INSTRUMENT CONSTANT MEASUREMENT

Instrument constant measurement should be performed after the suspension tape has been replaced or if the measuring location is greatly different in latitude from the previous location.

The instrument constant  $K$  and alignment constant  $R$  can be obtained using Instrument constant measurement when an accurate true north position is known. Three measurements are taken:  $0^{\circ} 00' 00''$  (true north),  $0^{\circ} 10' 00''$ ,  $359^{\circ} 50' 00''$ . After the instrument constants have been set, the current azimuth angle settings will be lost.



- When the horizontal angle is set to 0 in the Instrument constants measurement mode the current azimuth angle settings cease to be in effect and the azimuth angle is no longer displayed.

## ►PROCEDURE

1. Check that the GP1 is in the FULL CLAMP position.  
 "7.2 Preparing for Measurement with GP1"
2. Press **[CONST]** in the screen shown at right.

The current instrument constants are displayed.

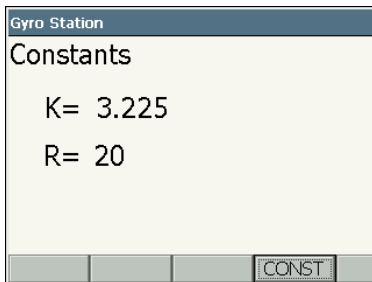
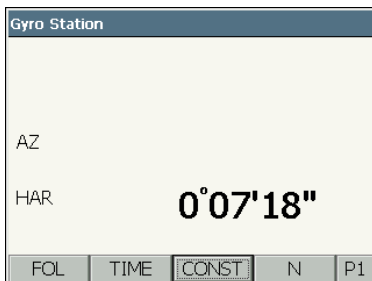

3. Press **[CONST]**.
4. Sight true north and press **[0Set]**.  
The horizontal angle will be set to  $0^\circ$ .

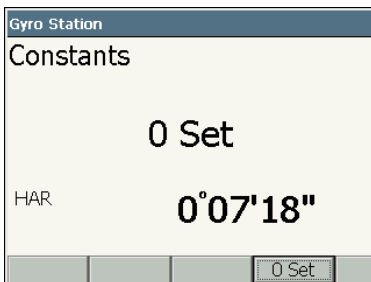

5. Sight the 1st direction and press **[OK]**.

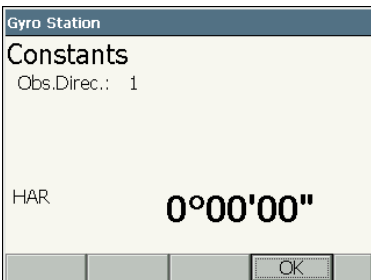

### ► PROCEDURE The first direction measurement

6. Set the GP1 to the HALF-CLAMP position and wait approx. 10 seconds to allow the movement of the floating index to settle. Then, slowly open to the FREE position.



- If the floating index appears to make fine oscillations after turning the clamping screw to the FREE position, turn the clamp halfway in the C direction. When these irregular movements have ceased release the clamp back to the FREE position.

## 11. INSTRUMENT CONSTANT MEASUREMENT

- For correct measurement, the index should have steady movement, and an R and L amplitude in the range of 8-10 graduations either side of 0. The amplitude of the index can be changed by first re-tightening the clamp to the FULL CLAMP position, then releasing again until the FREE position is reached once again.

7. Observe the movement of the index.

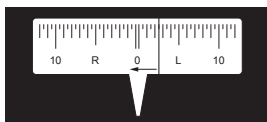



8. Read the position of the R/L-side turning point on the graduated scale to the nearest 0.1 units. Input this DR/DL value (amplitude) and press **[OK]**.

Gyro Station  
Constants  
Obs.Direc.: 1  
AMP  
DR ←   
DL →   
OK

9. At the moment the floating index crosses the zero graduations, press **[EPOCH]**.



Gyro Station  
Constants  
Obs.Direc.: 1  
Take Reading  
CE

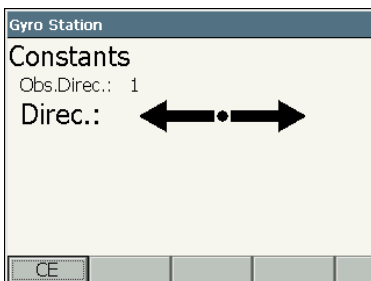

10. After the floating index has crossed the zero graduations input whether it is on the R or L side of the zero graduations. If it is on the R side of zero, press . If it is on the L side of zero, press . After inputting the direction, the relevant arrow symbol will be displayed.



11. At the moment the floating index crosses the zero graduations, press **[EPOCH]**.

- Incorrect input of  or  can be corrected by pressing the same key again.
- If a mistake is made when pressing **[EPOCH]** at the crossing of the zero graduations, the **[CE]** can be used to delete the last input value.
- After deleting the last input value by pressing **[CE]**, continue measurement starting with the next crossing of the zero graduations.

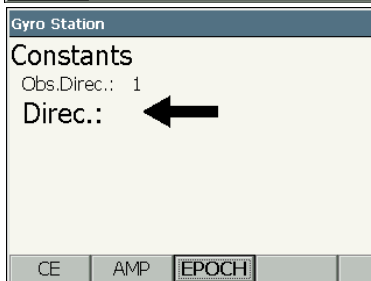

The time (sec.) taken for this half-cycle is displayed in "Half cycle(sec)".

- Press **[AMP]** to change the amplitudes (DR and DL) input in Step 7.
- If a mistake is made when pressing **[EPOCH]** at the crossing of the zero graduations, the **[CE]** can be used to delete the last input value.

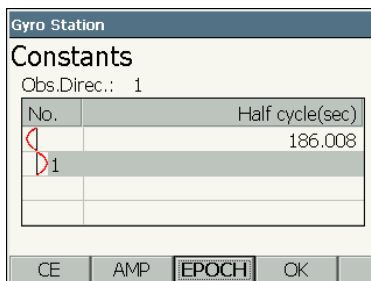

## 11. INSTRUMENT CONSTANT MEASUREMENT

---

- After deleting the last input value by pressing **[CE]**, continue measurement starting with the next crossing of the zero graduations.
12. At the moment the floating index crosses the zero graduations, press **[EPOCH]**. The time (sec.) taken for this half-cycle is displayed in "Half cycle(sec)". After the input of the full cycle, an audio warning is given approximately 20 seconds before the floating index is due to cross the zero graduations.
13. Continue to press **[EPOCH]** for the required number of crossings of the zero graduations. The maximum is 10.
14. When input is complete press **[OK]** and the 2nd direction measurement starts. After the 10th turning point has been measured, the 2nd direction measurement starts automatically.

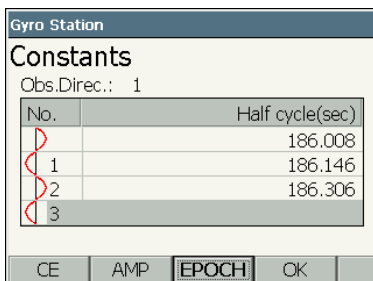

The screenshot shows a handheld device screen titled "Gyro Station" with a sub-header "Constants". Below the sub-header, it says "Obs.Direc.: 1". A table with two columns, "No." and "Half cycle(sec)", contains three rows of data. To the left of the table, there are three red curved arrows pointing to the right, corresponding to the three rows. At the bottom of the screen, there are five buttons: "CE", "AMP", "EPOCH", "OK", and a blank button.

No.	Half cycle(sec)
	186.008
1	186.146
2	186.306
3	

## ►PROCEDURE Second and third direction measurements

15. Turn the clamping screw in the C direction to the FULL CLAMP position and release to the HALF-CLAMP position.  
Then re-tighten to the FULL-CLAMP position.

16. Sight the 2nd direction (either  $0^{\circ} 10' 00''$  or  $359^{\circ} 50' 00''$  when true north is  $0^{\circ} 00' 00''$ ) and press **[OK]**.

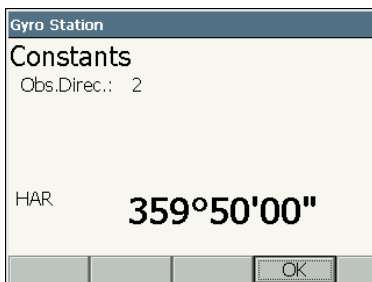

17. Perform measurement in the same way as  "PROCEDURE The first direction measurement".

18. Repeat the procedure shown in Step 15.

19. Sight the third direction (either  $0^{\circ} 10' 00''$  or  $359^{\circ} 50' 00''$  when true north is  $0^{\circ} 00' 00''$  - the direction not used for the 2nd direction measurement) and press **[OK]**.

20. Perform measurement in the same way as  "PROCEDURE The first direction measurement".

## 11. INSTRUMENT CONSTANT MEASUREMENT

---

21. Press **[OK]** at the end of the third measurement and the instrument constants K and R are calculated. To record these results press **[REC]**.

- Press **{ESC}** to display the quit mode confirmation screen. Press **[Yes]** to discard results.



- If constant R is large (greater than  $\pm 30''$ ), perform "14.3 Reticule Adjustment".

22. Turn the clamp to the FULL CLAMP position, then turn off the power to the GP1.

 "7.4 Finishing GP1 Measurement"

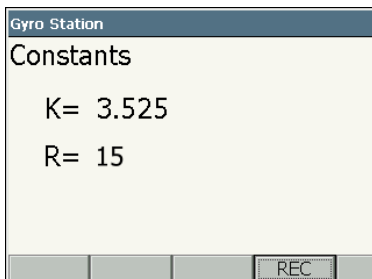

## 12. ERROR MESSAGES

The following is a list of the error messages displayed by the SET and the meaning of each message.

 For error messages not explained here, refer to the SETX operator's manual.

### Timeout

When **[EPOCH]** not input for a certain period in time measurement mode or instrument constants measurement mode.

When time measurement mode or instrument constants mode are forcibly ended, and the azimuth display is set.

In the time measurement mode, set the azimuth angle if it can be calculated.

When average calculated and measurement finished after error message displayed when previously calculated azimuth angle is set.

 "10. TIME MEASUREMENT", "11. INSTRUMENT CONSTANT MEASUREMENT"

### No solution

When divided by 0 or when the constant calculated exceeds the range in the instrument constants measurement mode.

The instrument constants measurement mode is ended and the azimuth display mode is set. The constant/azimuth angle measured before is effective. Check procedures in instrument constants measurement mode and perform measurement again. If the same error message is repeated, contact your local dealer.









### Confirm DR/DL input

The DL/DR (oscillation) values for time measurement mode or instrument constant measurement mode have not been input. Input the DL/DR (oscillation) values.

 "10. TIME MEASUREMENT", "11. INSTRUMENT CONSTANT MEASUREMENT"

# 13. TROUBLE SHOOTING

Perform the relevant "countermeasures" when the following problems occur. Contact your local dealer if the problem persists.

PROBLEM	COUNTERMEASURE
Battery lamp is lit	<ul style="list-style-type: none"> <li>Battery power is low. Ensure that the gyromotor is fully clamped then switch off the GP1. Remove and charge the battery.   "6. BATTERY CHARGING"</li> </ul>
Gyromotor does not run (The rotation sound cannot be heard.)	<ul style="list-style-type: none"> <li>Check if the battery lamp is lit red.   "Battery lamp is lit"</li> <li>Check if the cables are firmly connected.</li> <li>Check if the fuse of the Inverter is blown.   "13.1 Replacing the Fuse"</li> <li>Check if any cables are broken.</li> </ul>
Index mark does not move	<ul style="list-style-type: none"> <li>Check if the SET is levelled correctly.   SETX operator's manual</li> <li>Check to see if the suspension tape is broken.   "14.1 Checking the Suspension Tape"</li> </ul>
Index movement speed increases during observation:	<ul style="list-style-type: none"> <li>Check if the battery lamp is lit red.   "Battery lamp is lit"</li> </ul>
Graduations cannot be seen	<ul style="list-style-type: none"> <li>Check if the cables are firmly connected.</li> <li>Check if the battery lamp is lit red.   "Battery lamp is lit"</li> <li>Check if the bulb has blown. If so, replace the bulb.  "13.2 Replacing the Light Bulb"</li> </ul>
Motor start lamp does not light	<ul style="list-style-type: none"> <li>Check if the battery lamp is lit.   "Battery lamp is lit"</li> </ul>

## 13.1 Replacing the Fuse

If the motor does not run even when the power has been turned on, it is possible that the cause is a blown fuse. To replace a blown fuse, follow the procedure below.

### ►PROCEDURE

1. Turn the fuse screw (located on the base of the inverter) in a counterclockwise direction and pull out. The fuse is located on the inner portion of the fuse screw.
2. Remove the blown fuse and insert a fresh one. The fuse can be inserted in either direction.
3. Check that fuse is fitted properly. Insert the fuse screw back into the slot and turn in a clockwise direction to re-fasten.

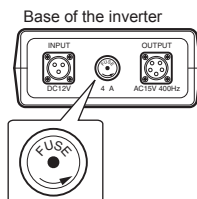

### 13.2 Replacing the Light Bulb

If the graduations cannot be seen when looking into the GP1 eyepiece, it is possible that the cause is a blown bulb. To replace a blown bulb, follow the procedure below.

#### ► PROCEDURE

1. Loosen the cover fixing screw located on the top of the illumination cover. Remove the cover.

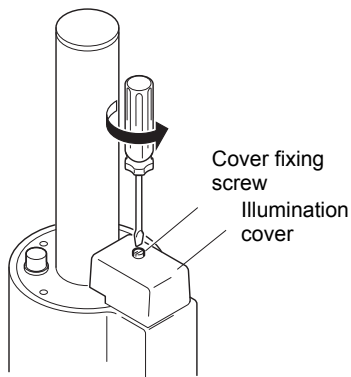

2. Push and turn the bulb in a counterclockwise direction. Remove the bulb.
3. Insert the new bulb into the slot, push and turn in a clockwise direction. Make sure that the bulb is fitted securely.
4. Retighten the cover fixing screw to secure the illumination cover back in place.

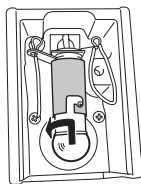



# 14. CHECKS AND ADJUSTMENTS

After the suspension tape has been replaced, or if the measuring station is greatly different in latitude from the previous one, perform the following checks and adjustments.

However, as it is necessary to know the true north position before checking (except for the zero point check), and to perform the checks precisely, it is recommended that your local dealer performs these checks.

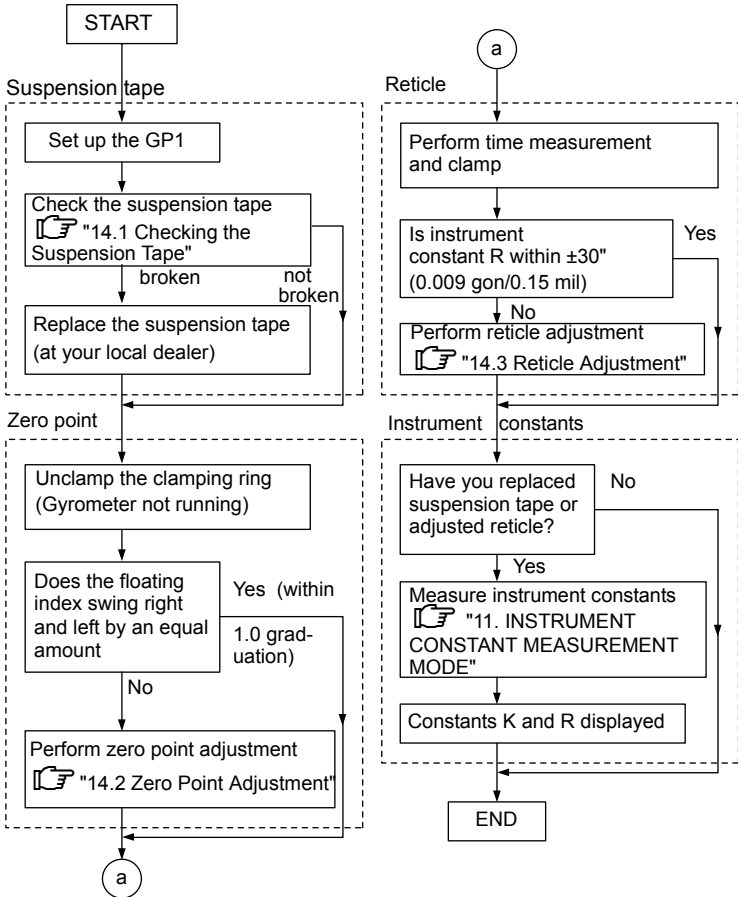

## 14. CHECKS AND ADJUSTMENTS

### 14.1 Checking the Suspension Tape

1. Set up the GP1 on the SET.  
 "7.1 Connecting the Instruments"
2. Unscrew and remove the GP1 cover tube.
3. Check if the tape is broken. If it is broken, contact your local dealer. Replacement of the suspension tape is carried out by our service representative.

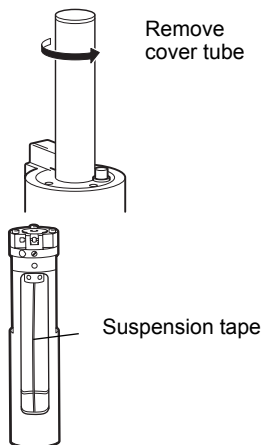

### 14.2 Zero Point Adjustment

This adjustment is necessary if the oscillation of the floating index is not symmetrical within 1.0 scale division.



- Always turn off the power to the GP1 when performing zero point adjustment. If the power is on, adjustment cannot be performed correctly.

#### ► PROCEDURE

1. Set up the GP1 on the SET.  
 "7.1 Connecting the Instruments"
2. Turn the telescope to the approximate true north position.
3. Remove the cover tube.

4. Unclamp the gyroscope pendulum by turning the clamping ring fully in the F direction.

5. Half-loosen the three set screws on the top of the suspension piece.

Adjust the zero adjustment screws while watching the floating index as follows:

When the R amplitude is larger than the L amplitude, loosen the right-side adjusting screw slightly and tighten the left-side adjusting screw by the same amount.

The screw adjusting procedure should be reversed if the L amplitude is larger than the R amplitude.

 Do not over-tighten the adjusting screws.

6. The adjustment is complete if the oscillation is symmetrical within 1.0 division about the zero point.

7. Tighten the upper three set screws and replace the cover tube.

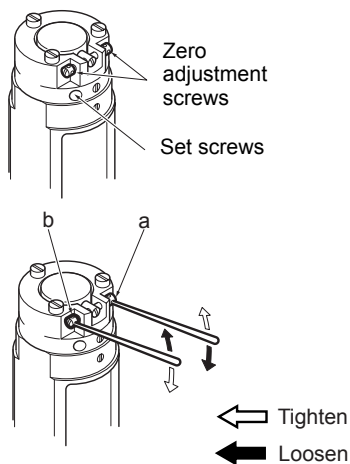

### 14.3 Reticle Adjustment

This adjustment is necessary if the alignment constant R is larger than 30" (0.009 gon/0.15 mil) after performing the instrument constant measurement, or if the difference between known and measured true north is greater than 30" (0.009 gon/0.15 mil).



- After this adjustment, the instrument constants measurement procedure should be performed.

 "11. INSTRUMENT CONSTANT MEASUREMENT"

## 14. CHECKS AND ADJUSTMENTS

---

### ►PROCEDURE Check

---

1. When the instrument is sighted on the known true north position, perform time measurement several times (input the R constant value as zero) and determine the difference between the measured and known true north positions.  
Turn the clamping ring to C to clamp the gyromotor.
2. To adjust, unscrew and remove the eyepiece cover and read the floating index position.
3. Adjust the reticle adjusting screws, considering that the amount of the shift is 0.1 divisions per 1' (0.02 gon/0.3 mil):  
When the measured value is between 30" and 1°00'00" (0.009 and 1.1 gon/0.15 and 18 mil), slightly loosen the adjusting screw on the left side and tighten the one on the right side by the same amount.

When the measured value is between 359°00'00" and 359°59'30" (398.9 and 399.991 gon/6382 and 6399.85 mil), loosen the adjusting screw on the right side and tighten the one on the left side by the same amount.

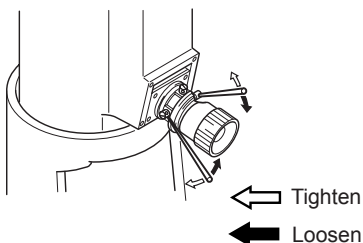

4. Replace the eyepiece cover.
5. Perform zero point adjustment.  
 "14.2 Zero Point Adjustment"
6. Repeat time measurement three times after the adjustment (with constant  $R = 0$ ) to determine the new measured D true north value. If the new value is greater than  $\pm 30''$  (0.009 gon/0.15 mil) repeat the above procedure from step 2).

# 15. STANDARD EQUIPMENT

Please verify that all equipment is included.

1

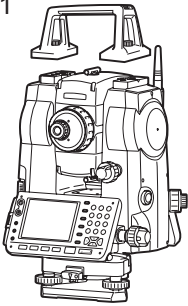

2

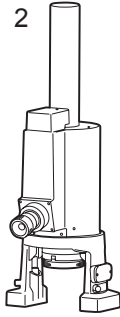

3



4



5



6



7



8



9



10



11



12



13

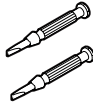

14



15



16



17



18



19



20



21

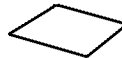

22



23

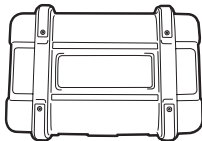

<p>1 SET main unit . . . . . 1          For SET accessories,   SETX operator's manual</p> <p>2 Gyroscope unit with bridge (GP1)          . . . . . 1</p> <p>3 Battery (BDC7A) . . . . . 1</p> <p>4 Charger (CDC75) . . . . . 1</p> <p>5 Inverter . . . . . 1</p> <p>6 Remote trigger (DLC1) . . . . . 1</p> <p>7 Coin-type battery (CR2032) . 1</p> <p>8 5-pin cable . . . . . 1</p> <p>9 3-pin cable . . . . . 1</p> <p>10 Bulb . . . . . 3</p>	<p>11 Fuse . . . . . 3</p> <p>12 Tool pouch . . . . . 1</p> <p>13 Watch-maker's screwdrivers. . 2</p> <p>14 Screwdriver . . . . . 1</p> <p>15 Lens brush . . . . . 1</p> <p>16 Adjusting pin . . . . . 3</p> <p>17 Lens hood . . . . . 1</p> <p>18 GP1 Tubular compass . . . . . 1</p> <p>19 Clamp lock . . . . . 1</p> <p>20 Vinyl cover . . . . . 1</p> <p>21 Cleaning cloth . . . . . 1</p> <p>22 Operator's manual . . . . . 1</p> <p>23 Carrying case . . . . . 1</p>
--	--

### ● Remote trigger (DLC1)

Changing battery cells



- Remove the battery cells when the remote trigger is not to be used for a long time.

### ► PROCEDURE

---

1. Pull the catch on the battery cover down. Remove the battery cover.

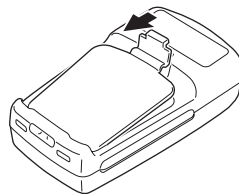

## 15. STANDARD EQUIPMENT

---

2. Slide the coin-type battery and press as shown at right to remove.

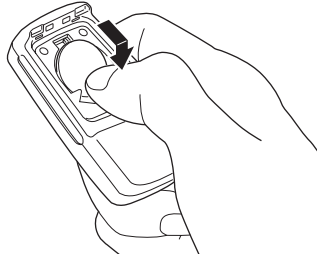

3. Insert a new battery with the + face up.
4. Fit the two prongs on the battery cover into the two notches, and close the battery cover. A click is heard when the cover is in place.

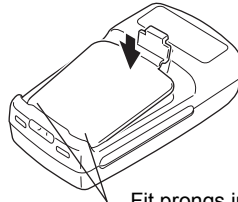

Fit prongs into notches



# 16. SPECIFICATIONS

## GP1 main unit

### Accuracy:

Follow-up measurement  $\pm 20''$  (0.006 gon/0.10 mil) (standard deviation)  
(when telescope pointed to within  $\pm 2^\circ$  of true north)

Time measurement  $\pm 20''$  (0.006 gon/0.10 mil) (standard deviation)  
(when telescope pointed to within  $\pm 20'$  of true north)

Running-up time: Approx. 60 sec

Half period (at middle latitudes):  
Approx. 3 min

Minimum interval between main divisions:  
Approx. 10' (0.185 gon/3 mil)/div.

GP1 mounting accuracy:  $\pm 5''$  (0.002 gon/0.025 mil)

Operating temperature:  $-20$  to  $50^\circ\text{C}$

Size: 145(W) x 186(D) x 416(H) mm  
(5.71(W) x 7.32(D) x 16.38(H) inch)

Weight: Approx. 3.8 kg (8.5 lb)

## Inverter

Input: 12V DC

Output: 115V AC, 400 Hz

12 V DC

Size: 130(W) x 55(D) x 240(H) mm  
(5.12(W) x 2.17(D) x 9.45(H) inch)

Weight: Approx. 1.6 kg (3.5 lb)

## Power supply

Power source: BDC7A Ni-MH rechargeable battery

Working duration at  $25^\circ\text{C}$ : Approx. 4 hours

### Battery (BDC7A)

Voltage: 12V DC

Capacity: 9Ah

Size: 140(W) x 50(D) x 250(H) mm  
(5.51(W) x 1.97(D) x 9.84(H) inch)

Weight: Approx. 2.2 kg (4.7 lb)

## 16. SPECIFICATIONS

---

### Charger (CDC75)

Input voltage:	100~240 VAC
Charging time:	Approx 9 hours
Size (excluding plug, protruding sections, and cable):	51.5(W) x 87.5(D) x 33(H)mm (2.03(W) x 3.44(D) x 1.3(H) inch)
Weight:	Approx. 180g (0.4 lb)

### Cables

5 pin:	1.5 m
3 pin:	1.0 m

### Remote trigger (DLC1)

Interface:	Modulated infrared LED
Power source:	Coin-type battery x 1 (CR2032) (3V DC)
Operating range:	within 0.5m (operating range may vary with different operating conditions)
Number of keys:	3
Dust and water resistance:	IP66 (IEC60529:2001)
Size:	40(W) x 68(D) x 22(H) mm (1.57(W) x 2.68(D) x 0.87(H) inch)
Weight:	Approx. 35g (0.08 lb) (with battery cell)

### SET1X/2X/3X/5X

Instrument size (with handle):	201 (W) X 220 (D) X 379 (H) mm (with optional Face 2 display, excluding protruding sections)
Instrument weight (with BDC58 and handle):	
Display on both sides:	7.2kg (16.0 lb)



For other SETX specifications, see SETX operator's manual

# 17. REGULATIONS

Users must ensure that their instrument is compliant with the relevant regulations and legal restrictions in place in the country of use.

## For users in the US

---

**WARNING:** Changes or modifications to this unit not expressly approved by the party responsible for compliance could void the user's authority to operate the equipment.

**NOTE:** This equipment has been tested and found to comply with the limits for a Class A digital device pursuant to Part 15 of the FCC Rules. These limits are designed to provide reasonable protection against harmful interference when the equipment is operated in a commercial environment. This equipment generates, uses, and can radiate radio frequency energy and, if not installed and used in accordance with the instruction manual, may cause harmful interference to radio communications. Operation of this equipment in a residential area is likely to cause harmful interference in which case the user will be required to correct the interference at his own expense.

## For users in California

**WARNING:** Handling the cord on this product or cords associated with accessories sold with this product will expose you to lead, a chemical known to the State of California to cause birth defects or other reproductive harm. ***Wash hands after handling.***

This product contains a CR Lithium Battery which contains Perchlorate Material - special handling may apply.

See <http://www.dtsc.ca.gov/hazardouswaste/perchlorate/>

Note: This is applicable to California, U.S.A only.

## For users in Canada

---

This Class A digital apparatus meets all requirements of Canadian Interference-Causing Equipment Regulations.

Cet appareil numérique de la Class A respecte toutes les exigences du Règlement sur le matériel brouilleur du Canada.

# 18. APPENDIX : PRINCIPLE OF THE GP1

The GPX pendulum-type gyroscope consists of a gyroscopic motor suspended by a tape and housed in a cylindrical body, which is mounted on the SETX total station.

The pendulum oscillates around the earth's meridian. This oscillation (called precession) is observed by the use of a mirror attached to the pendulum and can be followed without applying any torque to the suspension tape by slowly turning the theodolite (follow-up mode). Both turning points of the precessional oscillation can be read on the horizontal circle of the total station and the SET can calculate the centre of the precession (true north). When the optical axis of the theodolite is coincidental with the direction of the centre of precession, the instrument telescope is sighting true north.

### [Theory of the gyroscope]

The gyroscope is really a motor having a large moment of inertia, and spinning rapidly. When the angular momentum of the rotor is high, and the rotor is freely suspended, the direction of the rotating axis is kept unchanged in space.

The Earth is seen from the south.

Suppose a gyroscope started to oscillate over the arbitrary point A on the equator. It is assumed that the gyroscope has freedom in three axes as shown below.

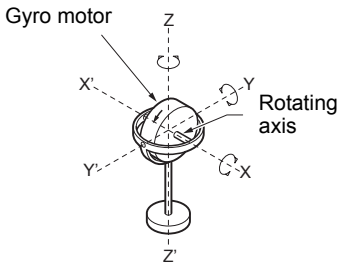
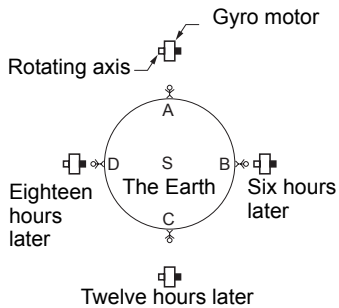

### [Degree of freedom in three axes]

The three axes are defined as shown. If the rotating axis of the gyroscope can freely change direction around the  $XX'$ ,  $YY'$ , and  $ZZ'$  axes, the gyroscope is said to have freedom in three axes.

Six hours later, the rotation of the earth will cause point A to reach point B. At that moment, the N end of the rotating axis faces the same direction as it did at point A. Similarly, 12 hours later, at point C and 18 hours later at point D, the direction of the axis will remain unchanged. Although an observer on the axis will perceive the direction of the axis to be changing, it must be remembered that, as described above, a gyroscope maintains its original rotating direction.

Besides the ability to maintain axis direction, the gyroscope has another important characteristic. When torque (twisting moment to change the axis direction) is applied to the rotating axis, the rotating axis starts moving in the direction of the torque vector due to precession.

If torque is applied to the rotating axis, lowering the N end of the rotating axis, while the gyro, which has freedom in three axes, is rotating clockwise as viewed from  $X'$ , the gyroscope will start rotating counterclockwise on the  $ZZ'$  axis as viewed from  $Z$ .

The original rotation of the rotor and the torque applied to the rotor which moves the N end downward are expressed as vectors  $H$  and  $T$ , respectively, based on the right-hand screw law.

The rotating vector  $H$  rotates in the direction of torque vector  $T$ , and this rotating motion is called precession.

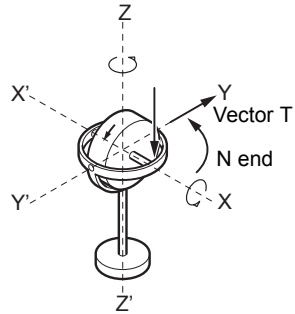

Direction of screw rotation

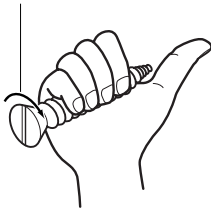

**[Right-hand screw law]**

The four fingers represent the direction of screw rotation, while the thumb indicates the advancing direction of the screw. Torque vector is defined as the direction of the thumb. The direction and amount of rotation are thus represented by a vector shown by the right-hand screw law.

**[Pendulum gyroscope]**

If the motor of a pendulum gyroscope is rotated clockwise viewed from end S of the rotating axis with another end N of the rotating axis facing east at an arbitrary point Q, the gyroscope changes its position from A to B, then B to C (see below) and finally the N end faces true north, i.e., the rotating axis aligns itself with the meridian by precession. Here it is assumed that the torque around the suspension tape is nil. Let us consider what causes the northward rotation of the N end.

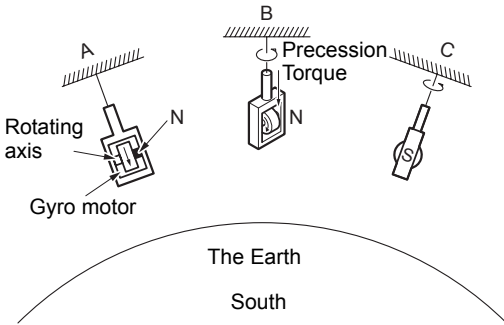

Even though the axis has a property which allows it to maintain its direction unchanged, end N of the axis must go down because of the rotation of the earth. In other words, when the Earth's gravity applies torque to the pendulum, its vector faces north. Therefore, end N of the axis (vector of rotor) starts a precession toward the north. Until end N precesses to the north, the torque caused by gravity is applied and the precession continues. The speed of precession is greatest in the north direction. After end N passes north, gravity applies torque to lower the new end N (old end S) downward. Therefore, the speed of precession decreases. When the new S end precesses to the same bearing at this end, a movement back to the north starts. Because the rotation of the Earth never stops, the back and forth motion around north will continue as long as the motor continues to rotate. This is the precession of a pendulum gyroscope.



# **SOKKIA TOPCON CO., LTD.**

<http://www.sokkia.co.jp/english/>

260-63 HASE, ATSUGI, KANAGAWA, 243-0036 JAPAN