

SOKKIA

SCT6

Construction Total Station



Class 1 LED Product

OPERATOR'S MANUAL



Li-ion

CONTAINS Li-ion BATTERY.
MUST BE RECYCLED OR DISPOSED OF PROPERLY.

JSIMA

:This is the mark of the Japan Surveying
Instruments Manufacturers Association.

SOKKIA

SCT6

Construction Total Station

Class 1 LED Product

OPERATOR'S MANUAL

- Thank you for selecting the SCT6.
- Before using the instrument, please read this operator's manual carefully.
- Verify that all equipment is included.
 - ☞ "29.1 Standard Equipment"
- SCT has a function to output data saved in the SCT to a connected host computer. Commands operations from a host computer can also be performed. For details, refer to "Interfacing with the SOKKIA SDR Electronic Field Book" and "Command Explanations" manuals and ask your Sokkia agent.
- The specifications and general appearance of the instrument may be altered at any time and may differ from those appearing in brochures and this manual.
- Some of the diagrams shown in this manual may be simplified for easier understanding.

READ THIS
FIRST

INTRODUCTION

PREPARATION
FOR
MEASURE-
MENT

MEASURE-
MENT
-MEASURE-
MENT
MODE

1.	PRECAUTIONS FOR SAFE OPERATION	1
2.	PRECAUTIONS	5
3.	HOW TO READ THIS MANUAL	7
4.	SCT FUNCTIONS	8
4.1	Parts of the Instrument	8
4.2	Mode Diagram	10
5.	BASIC OPERATION	11
5.1	Basic Key Operation	11
5.2	Display Functions	13
6.	USING THE BATTERY	15
6.1	Battery Charging	15
6.2	Installing/Removing the Battery	16
7.	SETTING UP THE INSTRUMENT	18
7.1	Centering	18
7.2	Levelling	19
8.	FOCUSSING AND TARGET SIGHTING	23
9.	POWER ON	25
10.	ANGLE MEASUREMENT	26
10.1	Measuring the Horizontal Angle between Two Points (Horizontal Angle 0°)	26
10.2	Setting the Horizontal Angle to a Required Value (Horizontal Angle Hold)	27
10.3	Angle Measurement and Outputting the Data	28
11.	DISTANCE MEASUREMENT	29
11.1	Distance and Angle Measurement	30
11.2	Recalling the Measured Data	31
11.3	Distance Measurement and Outputting the Data	32
11.4	Remote Elevation Measurement	33
12.	COORDINATE MEASUREMENT	35
12.1	Entering Instrument Station Data	35
12.2	Setting Azimuth Angle Setting from Backsight Coordinates	38
12.3	3-D Coordinate Measurement	40
12.4	Coordinate Measurement and Outputting the Data	42
13.	RESECTION MEASUREMENT	42
13.1	Coordinate Resection Measurement	43
13.2	Height Resection Measurement	47

MEASURE-
MENT
-MEASURE-
MENT
MODE-

14. STAKEOUT MEASUREMENT	51
14.1 Distance Stakeout Measurement	51
14.2 Coordinates Stakeout Measurement	54
14.3 REM Stakeout Measurement	57
15. STAKEOUT LINE	59
15.1 Defining Baseline	59
15.2 Stakeout Line Point	62
15.3 Stakeout Line Line	63
16. SETTING-OUT ARC.	66
16.1 Defining an Arc	66
16.2 Setting-out Arc.	70
17. POINT PROJECTION	72
17.1 Defining Baseline	72
17.2 Point Projection	73
18. INTERSECTIONS	75
19. MISSING LINE MEASUREMENT	79
19.1 Measuring the Distance between 2 or more Points	79
19.2 Changing the Starting Point	84
20. SURFACE AREA CALCULATION	86
21. RECORDING DATA - RECORD MENU -	91
21.1 Recording Instrument Station Data	91
21.2 Recording Backsight Point	93
21.3 Recording Angle Measurement Data	95
21.4 Recording Distance Measurement Data	97
21.5 Recording Coordinate Data	98
21.6 Recording Distance and Coordinate Data	99
21.7 Recording Notes	100
21.8 Reviewing JOB Data	100
21.9 Deleting Recorded JOB Data	103
22. SELECTING/DELETING A JOB	105
22.1 Selecting a JOB	105
22.2 Deleting a JOB	107
23. REGISTERING/DELETING DATA	108
23.1 Registering/Deleting Known Point Data	108
23.2 Reviewing Known Point Data	111
23.3 Registering/Deleting Codes	111

MANAGING THE
DATA
-JOB-DATA
MODE-

ADDITIONAL
DETAILS

23.4	Reviewing Codes	112
24.	OUTPUTTING JOB DATA	114
25.	CHANGING THE SETTINGS	116
25.1	Changing Instrument Options	116
25.2	Allocating Key Functions	122
25.3	Changing Password	125
25.4	Restoring Default Settings	126
26.	WIRELESS COMMUNICATION USING <i>BLUETOOTH</i> TECHNOLOGY	128
26.1	Necessary settings for <i>Bluetooth</i> communication	129
26.2	Establishing a connection between the SCT and paired <i>Bluetooth</i> device	133
26.3	Measurement using <i>Bluetooth</i> communication	134
26.4	Registering/Outputting data using <i>Bluetooth</i> communication	135
27.	WARNING AND ERROR MESSAGES	137
28.	CHECKS AND ADJUSTMENTS	141
28.1	Plate Level	141
28.2	Circular Level	142
28.3	Tilt Sensor	143
28.4	Collimation	147
28.5	Reticle	148
28.6	Optical plummet	149
28.7	Additive Distance Constant	151
29.	STANDARD EQUIPMENT AND OPTIONAL ACCESSORIES	153
29.1	Standard Equipment	153
29.2	Optional Accessories	155
29.3	Target System	157
29.4	Power Supply System	159
30.	SPECIFICATIONS	160
31.	EXPLANATION	164
31.1	Manually Indexing the Vertical Circle by Face Left, Face Right Measurement	164
32.	REGULATIONS	165



TROUBLE-
SHOOTING

INFORMATION
ABOUT
SCT

1. PRECAUTIONS FOR SAFE OPERATION

For the safe use of the product and prevention of injury to operators and other persons as well as prevention of property damage, items which should be observed are indicated by an exclamation point within a triangle used with WARNING and CAUTION statements in this operator's manual. The definitions of the indications are listed below. Be sure you understand them before reading the manual's main text.

Definition of Indication

 WARNING	Ignoring this indication and making an operation error could possibly result in death or serious injury to the operator.
 CAUTION	Ignoring this indication and making an operation error could possibly result in personal injury or property damage.



This symbol indicates items for which caution (hazard warnings inclusive) is urged. Specific details are printed in or near the symbol.



This symbol indicates items which are prohibited. Specific details are printed in or near the symbol.







This symbol indicates items which must always be performed. Specific details are printed in or near the symbol.

1. PRECAUTIONS FOR SAFE OPERATION

General





Warning

-  Do not use the unit in areas exposed to high amounts of dust or ash, in areas where there is inadequate ventilation, or near combustible materials. An explosion could occur.
-  Do not perform disassembly or rebuilding. Fire, electric shock, burns, or hazardous radiation exposure could result.
-  Never look at the sun through the telescope. Loss of eyesight could result.
-  Do not look at reflected sunlight from a prism or other reflecting object through the telescope. Loss of eyesight could result.
-  Direct viewing of the sun using the telescope during sun observation will cause loss of eyesight. Use solar filter (option) for sun observation.

 "29.1 Standard Equipment"









-  When securing the instrument in the carrying case make sure that all catches, including the side catches, are closed. Failure to do so could result in the instrument falling out while being carried, causing injury.

Caution

-  Do not use the carrying case as a footstool. The case is slippery and unstable so a person could slip and fall off it.
-  Do not place the instrument in a case with a damaged catch, belt or handle. The case or instrument could be dropped and cause injury.
-  Do not wield or throw the plumb bob. A person could be injured if struck.
-  Secure handle to main unit with locking screws. Failure to properly secure the handle could result in the unit falling off while being carried, causing injury.
-  Tighten the adjustment tribrach clamp securely. Failure to properly secure the clamp could result in the tribrach falling off while being carried, causing injury.

Power Supply

Warning

-  Do not use voltage other than the specified power supply voltage. Fire or electrical shock could result.
-  Do not use damaged power cords, plugs or loose outlets. Fire or electric shock could result.
-  Do not use power cords other than those designated. Fire could result.
-  Do not place articles such as clothing on the battery charger while charging batteries. Sparks could be induced, leading to fire.
-  Use only the specified battery charger to recharge batteries. Other chargers may be of different voltage rating or polarity, causing sparking which could lead to fire or burns.
-  Do not heat or throw batteries into fire. An explosion could occur, resulting in injury.
-  To prevent shorting of the battery in storage, apply insulating tape or equivalent to the terminals. Otherwise shorting could occur resulting in fire or burns.
-  Do not use batteries or the battery charger if wet. Resultant shorting could lead to fire or burns.
-  Do not connect or disconnect power supply plugs with wet hands. Electric shock could result.





Caution

-  Do not touch liquid leaking from batteries. Harmful chemicals could cause burns or blisters.

1. PRECAUTIONS FOR SAFE OPERATION





Tripod

Caution

-  When mounting the instrument to the tripod, tighten the centering screw securely. Failure to tighten the screw properly could result in the instrument falling off the tripod, causing injury.
-  Tighten securely the leg fixing screws of the tripod on which the instrument is mounted. Failure to tighten the screws could result in the tripod collapsing, causing injury.
-  Do not carry the tripod with the tripod shoes pointed at other persons. A person could be injured if struck by the tripod shoes.
-  Keep hands and feet away from the tripod shoes when fixing the tripod in the ground. A hand or foot stab wound could result.
-  Tighten the leg fixing screws securely before carrying the tripod. Failure to tighten the screws could lead to the tripod legs extending, causing injury.

Bluetooth wireless technology

Warning

-  Do not use within the vicinity of hospitals. Malfunction of medical equipment could result.
-  Use the instrument at a distance of at least 22 cm from anyone with a cardiac pacemaker. Otherwise, the pacemaker may be adversely affected by the electromagnetic waves produced and cease to operate as normal.
-  Do not use onboard aircraft. The aircraft instrumentation may malfunction as a result.
-  Do not use within the vicinity of automatic doors, fire alarms and other devices with automatic controls as they may be adversely affected by the electromagnetic waves produced resulting in malfunction and injury.

2. PRECAUTIONS

Tribrach Clamp

- When the instrument is shipped, the tribrach clamp is held firmly in place with a locking screw to prevent the instrument from shifting on the levelling base. Before using the instrument the first time, loosen this screw with a screwdriver. And before transporting it, tighten the locking screw to fasten the tribrach clamp in place so that it will not shift on the levelling base.

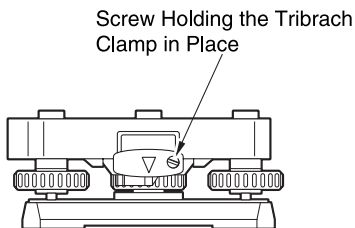

Precautions concerning water and dust resistance

SCT conforms to IP66 specifications for waterproofing and dust resistance when the battery cover is closed and connector caps are attached correctly.

- Be sure to close the battery cover and correctly attach the connector caps to protect the SCT from moisture and dust particles.
- Make sure that moisture or dust particles do not come in contact with the inside of the battery cover, terminal or connectors. Contact with these parts may cause damage to the instrument.
- Make sure that the inside of the carrying case and the instrument are dry before closing the case. If moisture is trapped inside the case, it may cause the instrument to rust.

Other precautions

- If the SCT is moved from a warm place to an extremely cold place, internal parts may contract, making the keys difficult to operate. This is caused by cold air trapped inside the hermetically sealed casing. If the keys do not depress, open the battery cover to resume normal functionality. To prevent the keys from becoming stiff, remove the connector caps before moving the SCT to a cold place.
- Never place the SCT directly on the ground. Sand or dust may cause damage to the screw holes or the centering screw on the base plate.
- Do not aim the telescope at the sun. Use the Solar filter to avoid causing internal damage to the instrument when observing the sun.
☞ "29.2 Optional Accessories"
- Protect the SCT from heavy shocks or vibration.
- Never carry the SCT on the tripod to another site.
- Turn the power off before removing the battery.

2. PRECAUTIONS

- When placing the SCT in its case, first remove its battery and place it in the case in accordance with the layout plan.
- Consult your Sokkia agent before using the instrument under special conditions such as long periods of continuous use or high levels of humidity. In general, special conditions are treated as being outside the scope of the product warranty.

Maintenance

- Always clean the instrument before returning it to the case. The lens requires special care. First, dust it off with the lens brush to remove tiny particles. Then, after providing a little condensation by breathing on the lens, wipe it with a soft clean cloth or lens tissue.
- If the display is dirty, carefully wipe it with a soft, dry cloth. To clean other parts of the instrument or the carrying case, lightly moisten a soft cloth in a mild detergent solution. Wring out excess water until the cloth is slightly damp, then carefully wipe the surface of the unit. Do not use any organic solvents or alkaline cleaning solutions.
- Store the SCT in a dry room where the temperature remains fairly constant.
- Check the tripod for loose fit and loose screws.
- If any trouble is found on the rotatable portion, screws or optical parts (e.g. lens), contact your Sokkia agent.
- When the instrument is not used for a long time, check it at least once every 3 months.





"28. CHECKS AND ADJUSTMENTS"

- When removing the SCT from the carrying case, never pull it out by force. The empty carrying case should be closed to protect it from moisture.
- Check the SCT for proper adjustment periodically to maintain the instrument accuracy.



3. HOW TO READ THIS MANUAL

Symbols

The following conventions are used in this manual.

-  : Indicates precautions and important items which should be read before operations.
-  : Indicates the chapter title to refer to for additional information.
-  : Indicates supplementary explanation.
-  : Indicates an explanation for a particular term or operation.
- [DIST] etc. : Indicates softkeys on the display.
- {ESC} etc. : Indicates operation keys on the SCT.
- <Resection> etc. : Indicates screen titles.

Notes regarding manual style

- Location of softkeys in screens used in procedures is based on the factory setting. It is possible to change the allocation of softkeys in Meas Mode.
-  What are softkeys: “4.1 Parts of the Instrument”, Softkeys allocation: “25.2 Allocating Key Functions”
- The names of softkeys in the main text of this manual may be depicted differently to the actual softkeys of the instrument.
- Learn basic key operations in “5. BASIC OPERATION” before you read each measurement procedure.
- Measurement procedures are based on continuous measurement. Some information about procedures when other measurement options are selected can be found in “Note” (.
- For selecting options and inputting figures, see “5.1 Basic Key Operation”
- *Bluetooth*[®] is a registered trademark of Bluetooth SIG, Inc.

4. SCT FUNCTIONS

4.1

Parts of the Instrument

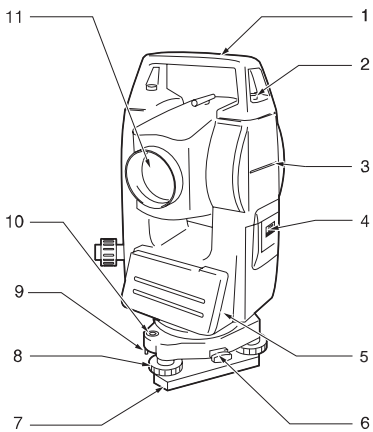

- 1 Handle
- 2 Handle securing screw
- 3 Instrument height mark
- 4 Battery cover
- 5 Data input/output connector
- 6 Tribrach clamp
- 7 Base plate
- 8 Levelling foot screw
- 9 Circular level adjusting screws
- 10 Circular level
- 11 Objective lens

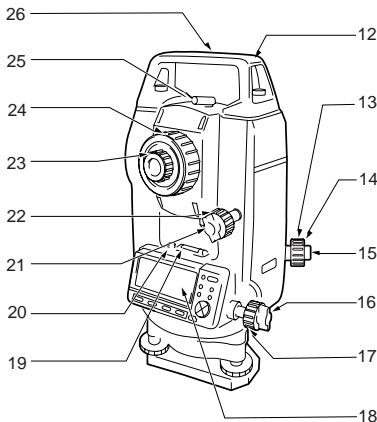

- 12 Tubular compass slot
- 13 Optical plummet focussing ring
- 14 Optical plummet reticle cover
- 15 Optical plummet eyepiece
- 16 Horizontal clamp
- 17 Horizontal fine motion screw
- 18 Display
- 19 Plate level
- 20 Plate level adjusting screw
- 21 Vertical clamp
- 22 Vertical fine motion screw
- 23 Telescope eyepiece
- 24 Telescope focussing ring
- 25 Peep sight
- 26 Instrument center mark

Operation panel

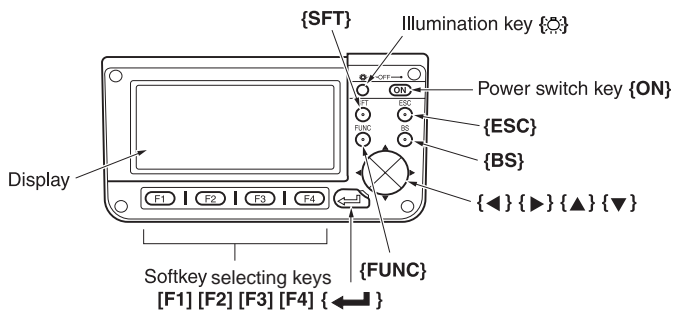
 "5.1 Basic Key Operation"

4.2 Mode Diagram

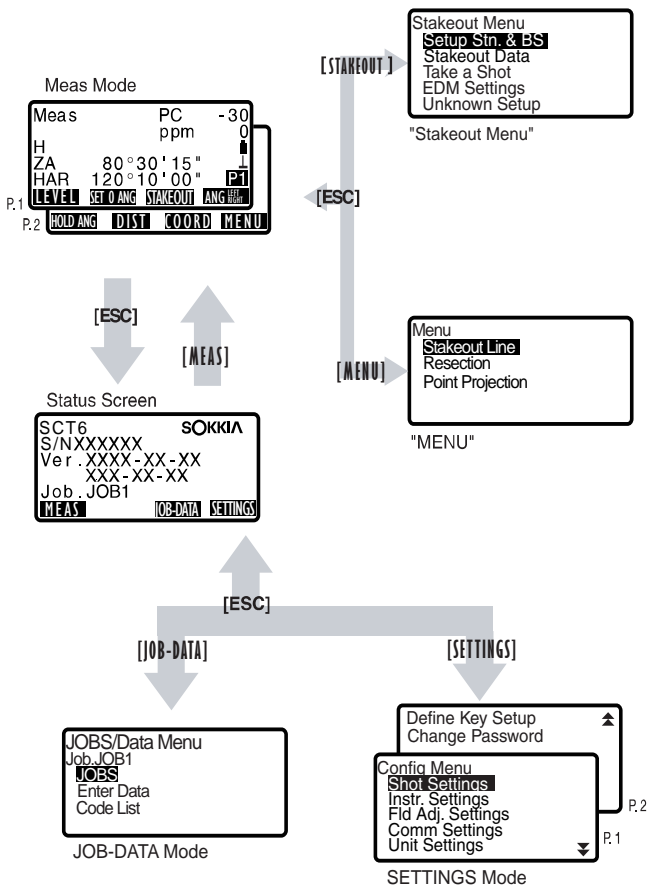

5. BASIC OPERATION

5.1 Basic Key Operation

Learn basic key operations here before you read each measurement procedure.

 Location of operation keys on the panel : “4.1 Parts of the Instrument”

● Power ON/OFF

{ON}: Power On

{ON} (while pressing) + : Power Off

● Lighting up the display

 : Switch the screen backlight On/Off

● Softkey operation

Softkeys are displayed on the bottom line of the screen.

{F1} to {F4}: Select the function matching the softkeys

{FUNC} : Toggle between Meas Mode screen pages (when more than 4 softkeys are allocated)

● Inputting letters/figures

{F1} to {F4}: Input a letter or a figure allocated to the softkey

{FUNC} : Go to the next softkey page (search for the letter or figure you want to input)

{FUNC} (hold for a moment): Go back one softkey page

{FUNC} (continue to hold): Go to previous softkey pages

{BS} : Delete a character on the left

{ESC} : Cancel the input data

{SFT} : Switch between upper and lower case

 : Select/accept input word/value

Example: Input of angle 125° 30' 00"(Input “125.3000”)

1. Allocate the **[H.ANG]** softkey to the Meas Mode screen.
2. Press **[H.ANG]** in page 2 of Meas Mode.
3. Press  to select “By Entering Angle”.
4. Press **[EDIT]**.
5. Press **[1]**. “1” is input and the cursor moves to next input position.
6. Press **[2]**.
7. Press **{FUNC}** to display the page in which **[5]** is allocated.
8. Press **[5]**.
9. Press **{FUNC}** to display the page in which **[.]** is allocated.

5. BASIC OPERATION

10. Input the remaining figures. When input is complete, press **{←}** to accept the value.

Backsight Angle
Shoot Backsight
ZA 105° 22' 33"
HAR 3° 36' 11"
HAR: 125.
1 2 3 4

Example: Input of distance 4 feet 9¾ inches (Input "4 09 3 4")

1. Press **[EDIT]** when distance field selected.
2. Press **[4]**. "4" is input and the cursor moves to next input position.
3. Press **{▶}** to insert a space.
4. Press **{FUNC}** to display the page in which **[0]** is allocated.
5. Press **[0]**.
6. Press **[9]**.
7. Press **{▶}** to insert a space.
8. Press **{FUNC}** to display the page in which **[3]** is allocated.
9. Press **[3]**.
10. Press **{▶}** to insert a space.
11. Press **[4]**.
12. Press **{←}** to accept the value.

Note

- When inputting alphabetic/numeric characters, press **{FUNC}** until the page in which letters/numbers are allocated is displayed.

● Selecting options

- {▲}/**{▼}**** : Up and down cursor
- {▶}/**{◀}**** : Right and left cursor/Select other option
- {←}** : Accept the option

Example: Select a reflector type

1. Press **[EDM SETTINGS]** when allocated to the Meas Mode screen.
2. Move to "Reflector" using **{▲}/**{▼}****.
3. Display the option you want to select using **{▶}/**{◀}****.
Switches between "Sheet" and "Prism."
4. Press **{←}** or **{▼}** to move to the next option.
The selection is set and you can set the next item.

EDM Settings
Mode : Fine "r"
Reflector: Prism
PC : -30
▼

● Switching modes

[SETTINGS]: From Status mode to SETTINGS mode

[MEAS] : From Status mode to Meas Mode (Measure Mode)

[JOB-DATA]: From Status mode to JOB-DATA Mode

{ESC} : Return to the Status mode from each Mode

☞ “4.2 Mode Diagram”

● Other operation

{ESC} : Return to the previous screen.

5.2 Display Functions

Status screen

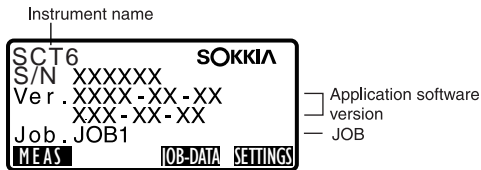

Meas Mode screen

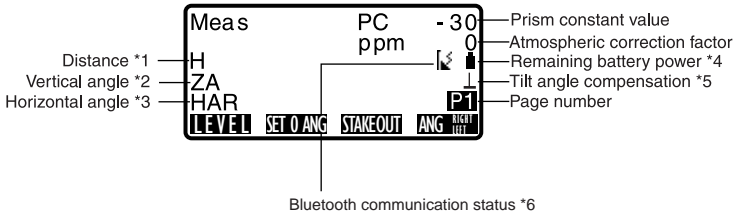

* 1 Distance

☞ Switching distance display status: “25.1 Changing Instrument Options ● Settings in SETTINGS mode”

S : Slope distance

H : Horizontal distance

V : Height difference

* 2 Vertical angle

☞ Switching vertical angle display status: “25.1 Changing Instrument Options ● Settings in SETTINGS mode”

ZA : Zenith angle (Z=0)

VA : Vertical angle (H=0/H=±90)

5. BASIC OPERATION

To switch vertical angle/slope in %, press **[ZA/%]** when allocated to the Meas mode screen.

* 3 Horizontal angle

Press **[ANG RIGHT LEFT]** to switch the display status.

HAR: Horizontal angle right

HAL: Horizontal angle left

* 1,2,3

To switch usual "H, ZA, HAR" display to "S, H, V", press **[▲ SHV DISPLAY]** when allocated to the Meas mode screen.

* 4 Remaining battery power (BDC46B, Temperature=25°C, EDM on)

 : level 3 Full power.

 : level 2 Plenty of power remains.

 : level 1 Half or less power remains.

 : level 0 Little power remains. Charge the battery.

 (This symbol is displayed every 3 seconds): No power remains.
Stop the measurement and charge the battery.

 "6.1 Battery Charging"

* 5 Tilt angle compensation

When this symbol is displayed, the vertical and horizontal angles are automatically compensated for small tilt errors using 2-axis tilt sensor.

 Tilt compensation setting: "25.1 Changing Instrument Options ●
Settings in SETTINGS mode"

*6 Bluetooth communication status

: Connection established ("Mode" is set to "Slave")

: Connection established ("Mode" is set to "Master")

 (flashing): Connecting ("Mode" is set to "Slave")

 (flashing): Connecting ("Mode" is set to "Master")

 (flashing): Waiting

 (flashing): Disconnecting ("Mode" is set to "Slave")

 (flashing): Disconnecting ("Mode" is set to "Master")

: Bluetooth device is OFF ("Mode" is set to "Slave")

: Bluetooth device is OFF ("Mode" is set to "Master")

6. USING THE BATTERY

6.1 Battery Charging

The battery has not been charged at the factory.



- Do not short circuit. Heat or ignition could result.
- Batteries cannot be charged, even when the charging lamp is flashing, when the temperature is outside the charging temperature range.
- Do not leave the battery in places exposed to high temperatures (more than 35°C). Doing so may reduce the life of the battery.
- Charge the battery once a month to maintain its quality when not in use for long periods.
- Do not charge the battery just after charging is completed. Battery performance may decline.
- Do not use to charge batteries other than those specified.
- If you allow the battery level to get too low, the battery may not be rechargeable or operating time may decline. Keep the battery always charged.
- The charger will become rather hot during use. This is normal.

►PROCEDURE

1. Connect the power cable to the CDC68 charger and plug the charger into the wall outlet.
2. Mount the battery (BDC46B) in the charger (CDC68) matching the groove on the battery with the guides on the charger. When charging starts, the lamp starts blinking.
3. Charging takes approximately 2 hours. The lamp lights when charging is finished.
4. Remove the battery and unplug the charger.

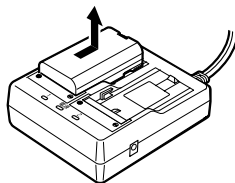
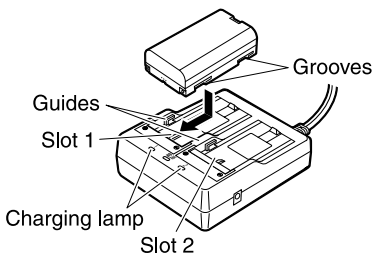

6. USING THE BATTERY



- Slots 1 and 2: The charger starts charging the battery mounted first. If you place two batteries in the charger, the battery in slot 1 is charged first, and then the battery in slot 2. (step 2)
- Charging lamp: The charging lamp is off when the charger is outside the charging temperature range or when the battery is mounted incorrectly. If the lamp is still off after the charger falls within its charging temperature range and the battery is mounted again, contact your Sokkia agent. (steps 2 and 3)

6.2 Installing/Removing the Battery

Mount the charged battery.



- When removing the battery, turn the power off.
- When installing/removing the battery, make sure that moisture or dust particles do not come in contact with the inside of the instrument.

►PROCEDURE

1.

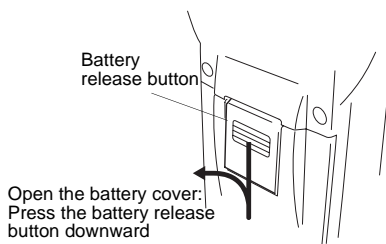

2.

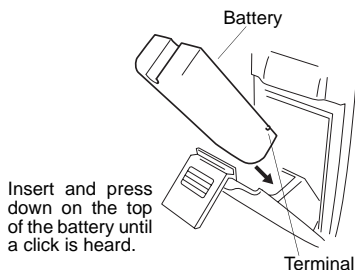

3.

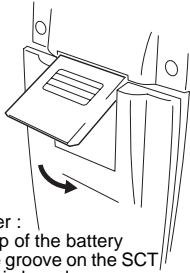

Close the battery cover :
Insert the lip on the top of the battery
release button into the groove on the SCT
and press until a click is heard.

Note

- Battery cover

If the battery cover is open during power on, SCT notifies you by displaying the screen below and beeping.

When the battery cover is closed, the previous screen is restored.

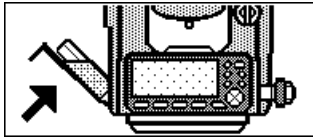

7. SETTING UP THE INSTRUMENT



- Mount the battery in the instrument before performing this operation because the instrument will tilt slightly if the battery is mounted after levelling.

7.1 Centering

► PROCEDURE

1. Make sure the legs are spaced at equal intervals and the head is approximately level.
Set the tripod so that the head is positioned over the surveying point.
Make sure the tripod shoes are firmly fixed in the ground.

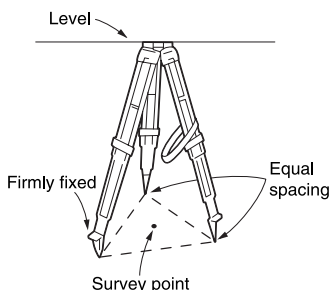

2. Place the instrument on the tripod head.
Supporting it with one hand, tighten the centering screw on the bottom of the unit to make sure it is secured to the tripod.

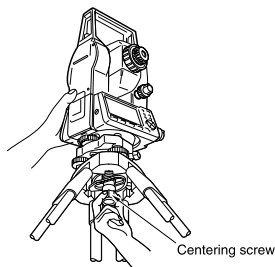

3. Looking through the optical plummet eyepiece, turn the optical plummet eyepiece to focus on the reticle.
Turn the optical plummet focusing ring to focus on the surveying point.

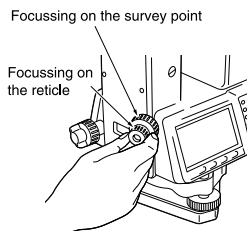

7.2 Levelling

Instrument can be levelled using the screen.

 **Note** Levelling on the screen”

► PROCEDURE

1. Adjust the levelling foot screws to center the surveying point in the optical plummet reticle.
2. Center the bubble in the circular level by either shortening the tripod leg closest to the offcenter direction of the bubble or by lengthening the tripod leg farthest from the offcenter direction of the bubble. Adjust one more tripod leg to center the bubble.

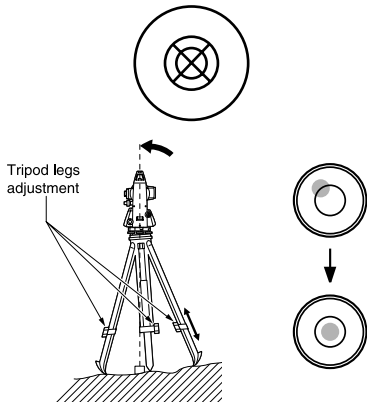

3. Loosen the horizontal clamp to turn the upper part of the instrument until the plate level is parallel to a line between levelling foot screws A and B. Center the air bubble using levelling foot screws A and B. The bubble moves towards a clockwise rotated levelling foot screw.

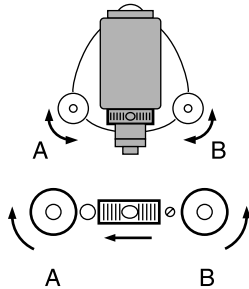

7. SETTING UP THE INSTRUMENT

4. Turn the upper part of the instrument through 90° . The plate level is now perpendicular to a line between levelling foot screws A and B. Center the air bubble using levelling foot screw C.

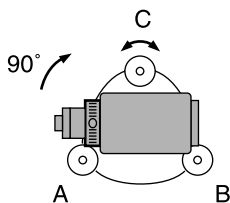

5. Turn the upper part of the instrument a further 90° and check to see if the bubble is still in the center of the plate level. If the bubble is off-center, perform the following:
- Turn levelling foot screws A and B equally in opposite directions to remove half of the bubble displacement.
 - Turn the upper part a further 90° , and use levelling foot screw C to remove half of the displacement in this direction.

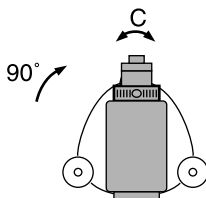

Or adjust the plate level.

 "28.1 Plate Level"

6. Turn the instrument and check to see if the air bubble is in the same position in all directions. If it is not, repeat the levelling procedure.

7. Loosen the centering screw slightly.
Looking through the optical plummet eyepiece, slide the instrument over the tripod head until the surveying point is exactly centered in the reticle.
Retighten the centering screw securely.

8. Check again to make sure the bubble in the plate level is centered.
If not, repeat the procedure starting from step 3.

7. SETTING UP THE INSTRUMENT

►PROCEDURE Levelling on the screen

1. Press **[LEVEL]** in the first page of Meas Mode to display the circular level on the screen.

“●” indicates bubble in circular level. The range of the inside circle is $\pm 3'$ and the range of the outside circle is $\pm 6'$.

Tilt angle values X and Y are also displayed on the screen.

2. Center “●” in the circular level
 “7.2 Levelling” steps 1 to 2

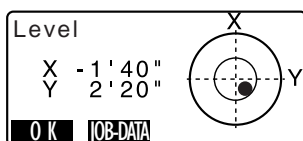

3. Turn the instrument until the telescope is parallel to a line between levelling foot screws A and B, then tighten the horizontal clamp.
4. Set the tilt angle to 0° using foot screws A and B for the X direction and levelling screw C for the Y direction.
5. Press **{ESC}** to return to Meas Mode.

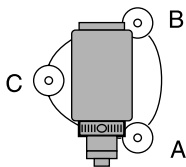

8. FOCUSING AND TARGET SIGHTING



- When sighting the target, strong light shining directly into the objective lens may cause the instrument to malfunction. Protect the objective lens from direct light by attaching the lens hood.
Observe to the same point of the reticle when the telescope face is changed.

►PROCEDURE

1. Look through the telescope eyepiece at a bright and featureless background. Turn the eyepiece clockwise, then counterclockwise little by little until just before the reticle image becomes focussed. Using these procedures, frequent reticle refocussing is not necessary since your eye is focussed at infinity.
2. Loosen the vertical and horizontal clamps, then use the peep sight to bring the target into the field of view. Tighten both clamps.
3. Turn the telescope focussing ring to focus on the target. Turn the vertical and horizontal fine motion screws to align the target with the reticle. The last adjustment of each fine motion screw should be in the clockwise direction.

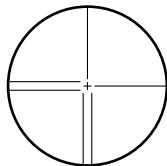

8. FOCUSING AND TARGET SIGHTING

4. Readjust the focus with the focussing ring until there is no parallax between the target image and the reticle.



Eliminating parallax

This is the relative displacement of the target image with respect to the reticle when the observer's head is moved slightly before the eyepiece. Parallax will introduce reading errors and must be removed before observations are taken. Parallax can be removed by refocussing the reticle.

9. POWER ON

Setting "V manual": "25.1 Changing Instrument Options • Settings in SETTINGS Mode", Setting/changing password: "25.3 Changing Password"

►PROCEDURE

1. Press {ON}.

When the power is switched on, a self-check is run to make sure the instrument is operating normally.

- When password is set, the display appears as at right. Input password and press {←}.

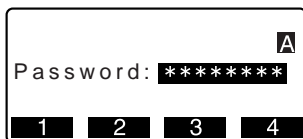

- When "V manual" is set to "Yes", the display appears as at right.

Manually indexing the vertical circle by face left, face right measurements:

"31. EXPLANATION"

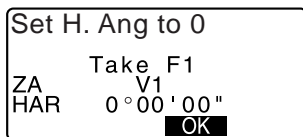

2. The Level screen appears. Center "●" in the circular level.

"7.2 Levelling" steps 1 to 2

- Press [JOB-DATA] to display <Jobs/Data Menu>.

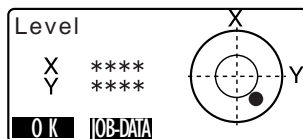

After that, the Meas Mode screen appears.

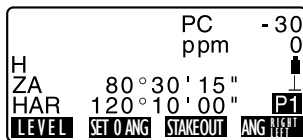

- When "Resume" in "Instr. Settings" is set to "On", the screen previous to power off is displayed.

"25.1 Changing Instrument Options • Settings in SETTINGS mode"

- "Level crn" in "Shot Settings" should be set to "No" if the display is unsteady due to vibration or strong wind.

"25.1 Changing Instrument Options • Settings in SETTINGS mode"

10. ANGLE MEASUREMENT

This section explains the procedures for basic angle measurement.

10.1 Measuring the Horizontal Angle between Two Points (Horizontal Angle 0°)

Use the "SET 0 ANG" function to measure the included angle between two points. The horizontal angle can be set to 0 at any direction.

► PROCEDURE

1. Sight the first target as at right.

1st target

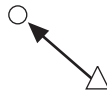

Instrument Station

2. In the first page of the Meas mode screen, press [SET 0 ANG].

[SET 0 ANG] will flash, so press [SET 0 ANG] again.

The horizontal angle at the first target becomes 0°.

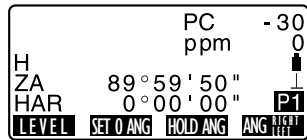

3. Sight the second target.

2nd Target

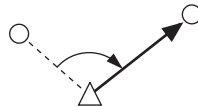

The displayed horizontal angle (HAR) is the included angle between two points.

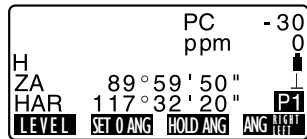

10.2 Setting the Horizontal Angle to a Required Value (Horizontal Angle Hold)

You can reset the horizontal angle to a required value and use this value to find the horizontal angle of a new target.

► PROCEDURE

1. Allocate the **[H.ANG]** softkey to the Meas Mode screen.
2. Sight the first target.
3. Press **[H.ANG]** and select "By Entering Angle".
4. Press **[EDIT]** and enter the angle you wish to set, then press **[OK]**. The value that is input as the horizontal angle is displayed.
 - When **[REC]** is pressed, backsight angle can be set and recorded in the current JOB.
 - ☞ "21.2 Recording Backsight Point"
5. Sight the second target. The horizontal angle from the second target to the value set as the horizontal angle is displayed.

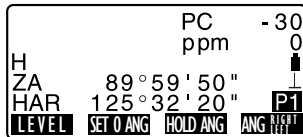
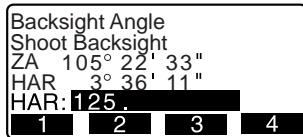

Note

- Pressing **[HOLD ANG]** performs the same function as above.
- Press **[HOLD ANG]** to set the displayed horizontal angle. Then, set the angle that is in hold status to the direction you require.
 - ☞ Allocating **[HOLD ANG]**: "25.2 Allocating Key Functions"

10.3 Angle Measurement and Outputting the Data

The following explains angle measurement and the features used to output measurement data to a computer or peripheral equipment.

 Communication cables: “29.2 Optional Accessories”

Output format and command operations: “Interfacing with the SOKKIA SDR Electronic Field Book” and “Command Explanations” manuals.

► PROCEDURE

1. Connect SCT and host computer.
2. Allocate the **[STREAM DATAOUT]** softkey to the Meas mode screen.
 “25.2 Allocating Key Functions”
3. Sight the target point.
4. Press **[STREAM DATAOUT]** and select “Angle Data.”
Output measurement data to peripheral equipment.

11. DISTANCE MEASUREMENT

Perform the following settings as preparation for distance measurement.

- Distance measurement mode
- Target type
- Prism constant correction value
- Atmospheric correction factor
- EDM Standby
- EDM ALC

 "25.1 Changing Instrument Options ● EDM Settings/● Settings in SETTINGS mode"s

- Check to make sure that sufficient reflected light is returned by the reflective prism sighted by the telescope. Checking the returned signal is particularly useful when performing long distance measurements.



- When the light intensity is sufficient even though the center of the reflective prism and the reticle are slightly misaligned (short distance etc.), "*" will be displayed in some cases, but in fact, accurate measurement is impossible. Therefore make sure that the target center is sighted correctly.
- Scintillation may affect the accuracy of distance of measurement results. Should this occur, repeat measurement several times and use the averaged value of the obtained results.

►PROCEDURE Returned Signal Checking

1. Allocate the **[SIGNAL DETECT]** softkey to the Meas mode screen.

 "25.2 Allocating Key Functions"

2. Accurately sight the target.
3. Press **[SIGNAL DETECT]**.
<Detecting Signal> is displayed.
The intensity of the light of the returned signal is displayed by a gauge.

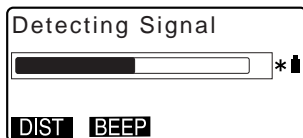

- The more  displayed, the greater the quantity of reflected light.

11. DISTANCE MEASUREMENT

- If “**” is displayed; only enough light for the measurement is returned.
- When “**” is not displayed, accurately resight the target.
- Press **[BEEP]** to make a buzzer sound when measurement is possible. Press **[OFF]** to shut off the buzzer.
- Press **[DIST]** to shift distance measurement.
- Press **{ESC}** to finish signal checking and return to Meas Mode.



- When ██████████ is displayed persistently, contact your Sokkia agent.
- If no key operations are performed for two minutes, the display automatically returns to the Meas mode screen.

11.1 Distance and Angle Measurement

An angle can be measured at the same time as the distance.

►PROCEDURE

1. Sight the target.
2. In the second page of Meas Mode, press **[DIST]** to start distance measurement.

When measurement starts, EDM information (distance mode, prism constant correction value, atmospheric correction factor) is represented by a flashing light.

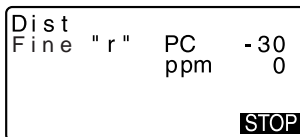

A short beep sounds, and the measured distance data (H), vertical angle (ZA), and horizontal angle (HAR) are displayed.

	PC	- 30
	ppm	0
H	23-04-1/4	↓
ZA	80°30'10"	↓
HAR	120°10'00"	P1
		STOP

3. Press **[STOP]** to quit distance measurement.

- Each time **[SHV DISPLAY]** is pressed when allocated to the Meas Mode screen, S (Slope distance), H (Horizontal distance) and V (Height difference) are displayed alternately.

	PC	- 30
	ppm	0
S	1601-04-1/2	↓
H	1587-02-1/2	↓
V	230-11-1/2	P1
LEVEL	SET 0 ANG	HOLD ANG
	ANG	RIGHT LEFT

Note

- If the single measurement mode is selected, measurement automatically stops after a single measurement.
- During fine average measurement, the distance data is displayed as S-1, S-2, ... to S-9. When the designated number of measurements has been completed, the average value of the distance is displayed in the [S-A] line.
- The distance and angle that are most recently measured remain stored in the memory until the power is off and can be displayed at any time.
 "11.2 Recalling the Measured Data"

11.2 Recalling the Measured Data

The distance and angle that are most recently measured remain stored in the memory until the power is off and can be displayed at any time.

The distance measurement value, vertical angle, horizontal angle, and the coordinates can be displayed. Distance measurement values converted into the horizontal distance, elevation difference, and the slope distance can also be displayed.

► PROCEDURE

1. Allocate the **[RECALL ANGLE]** softkey to the Meas mode screen.
 "25.2 Allocating Key Functions"

11. DISTANCE MEASUREMENT

2. Press **[RECALL ANGLE]**.
The stored data that is most recently measured is displayed.

H	1801-04-1/2
ZA	80°30'10"
HAR	120°10'10"
N	-422-06-3/4
E	-746-07-1/4
Z	99-08-1/2

- If you have pressed **[SHV DISPLAY]** beforehand, the distance values are converted into the horizontal distance, elevation difference, and the slope distance and recalled.

3. Press **{ESC}** to return to Meas mode.

11.3 Distance Measurement and Outputting the Data

The following explains distance measurement and the features used to output measurement data to a computer or peripheral equipment.

 Communication cables: “29.2 Optional Accessories”

Output format and command operations: “Interfacing with the SOKKIA SDR Electronic Field Book” and “Command Explanations” manuals.

►PROCEDURE

1. Connect SCT and host computer.
2. Allocate the **[STREAM DATAOUT]** softkey to the Meas mode screen.
 “25.2 Allocating Key Functions”
3. Sight the target point.
4. Press **[STREAM DATAOUT]**, and select “Dist data” to measure the distance and output the data to peripheral equipment.
5. Press **[STOP]** to stop the data outputting and return to Meas Mode.

11.4 REM Measurement

An REM measurement is a function used to measure the height to a point where a target cannot be directly installed such as power lines, overhead cables and bridges, etc.

The height of the object is calculated using the following formula.

$$H_t = h_1 + h_2$$

$$h_2 = S \sin \theta_{z1} \times \cot \theta_{z2} - S \cos \theta_{z1}$$

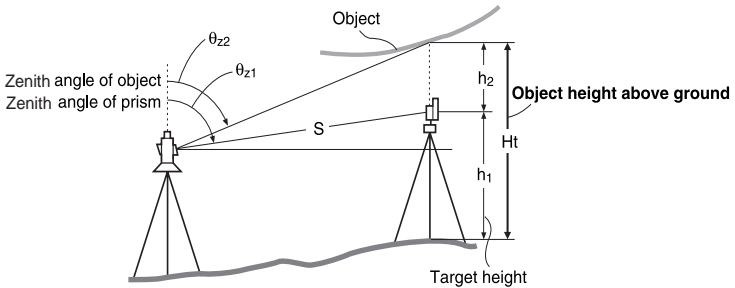

►PROCEDURE

1. Allocate the **[REMOTE ELEV]** softkey to the Meas mode screen.
 "25.2 Allocating Key Functions"
2. Set the target directly under or directly over the object and measure the rod height with a tape measure etc.

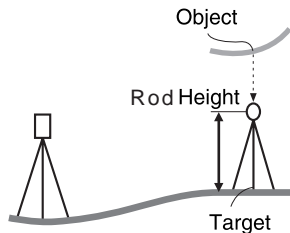

3. After inputting the rod height, accurately sight the target.
 "Note"
 Press **[DIST]** in page 2 of Meas Mode to carry out measurement.

11. DISTANCE MEASUREMENT

The measured distance data (H), vertical angle (ZA), and horizontal angle (HAR) are displayed.

Press **[STOP]** to stop the measurement.

4. Sight the object, then press **[REMOTE ELEV]**. The REM measurement is started and the height from the ground to the object is displayed in "Ht."

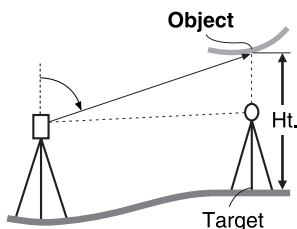
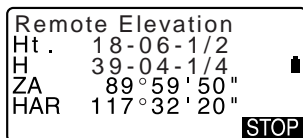

5. Press **[STOP]** to terminate the measurement operation.

- To re-observe the target, sight the target, then press **[TAKESHOT]**.
- When **[RECORD]** is pressed, REM data is saved.

 "21. RECORDING DATA - RECORD MENU -"

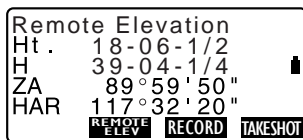

6. Press **{ESC}** to finish measurement and return to the Meas mode screen.



- Inputting instrument and rod height (Step 3): Press **[INSTR/ROD HT]** when allocated to the Meas Mode screen to set rod height. It can be set also in "Setup Stn. & BS" of coordinate measurement.

 "12.1 Entering Instrument Station Data and Azimuth Angle"

12. COORDINATE MEASUREMENT

By performing coordinate measurements it is possible to find the 3-dimensional coordinates of the target based on station point coordinates, instrument height, rod height, and azimuth angles of the backsight station which are entered in advance.

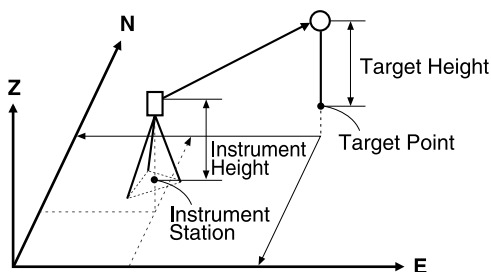

- EDM setting can be done in coordinate measurement menu.
☞ Setting items: "25.1 Changing Instrument Options ● EDM Settings"

12.1 Entering Instrument Station Data and Azimuth Angle

Before coordinate measurement, enter instrument station coordinates, the instrument height, rod height, and azimuth angle.

► PROCEDURE

1. First measure the rod height and instrument height with a tape measure, etc.
2. Press **[COORD]** in the second page of the Meas mode screen to display <Coordinate Menu>.

12. COORDINATE MEASUREMENT

3. Select "Setup Stn. & BS".
Press **[EDIT]**, then input the instrument station coordinates, point number, and instrument height.

```

NO:      0-00-0
EO:      0-00-0
ZO:      0-00-0
Pt.      100
Inst.HT  42-00-1/4
LIST  BSANGLE  BSCOORD  EDIT
    
```

4. Press **[BS ANGLE]** in the screen of step 3 to proceed to azimuth angle input.

```

NO:      1221-00-0
EO:      33-00-0
ZO:      330-00-0
Pt.      100
Inst.HT  42 00 1 4
1  2  3  4
    
```

- Press **[BS COORD]** to calculate azimuth angle input from backsight coordinates.

```

Backsight
Shoot Backsight
ZA      89°59'55"
HAR     117°32'20"
Azimuth 0°00'00"
RECORD  NO  YES
    
```

 "12.2 Setting Azimuth Angle Setting from Backsight Coordinates"

- When you wish to read in the registered coordinate data, press **[LIST]**.

 "PROCEDURE Reading in Registered Coordinate Data"

5. Input azimuth angle and press **[OK]** to set the input values.
<Coordinate Menu> is displayed again.

- Press **[RECORD]** to record code, rod height and point number values. Press **[OK]** to set the input values and return to <Coordinate Menu>.

```

ZA      89°59'55"
HAR     117°32'20"
Cd      ██████████
Rod HT  0-00-0 ↓
OK  ADD  LIST  EDIT
    
```

►PROCEDURE Reading in Registered Coordinate Data

Known point data, coordinate data and instrument station data in the current JOB can be read in.

 “23.1 Registering/Deleting Known Point Data”, “22.1 Selecting a JOB”

- Press **[LIST]** when setting Instrument Station.
The list of registered coordinates is displayed.
Pt. : Known point data saved in the current JOB.
Crđ./Stn : Coordinate data saved in the current JOB.

Pt.	11111111	▲	
Pt.	1		
Crđ.	2		
Stn	12345679		
Stn	1234	▼	
↑↓...P	TOP	LAST	SEARCH

- Align the cursor with the required point number and press **{←}**.
The point number that was read in and its coordinates are displayed.

N0:	32-07-1/4		
E0:	17-11-1/2		
Z0:	<Null>	■	
Pt.	100		
Inst.HT	0-00-0		
	BSANGLE	BSCOORD	EDIT

- **[↑↓...P]** = Use **{▲}**/**{▼}** to select individual point.
- **[↑↓...P]** = Use **{▲}**/**{▼}** to move from page to page.
- Press **[TOP]** to move to the first point number on the first page.
- Press **[LAST]** to move to the last point number on the last page.
- Press **[SEARCH]** to move to the “Coordinate Data Search Screen.” Input the point number you want to search in “Pt. no.”
The search may take time if many data are registered.

12. COORDINATE MEASUREMENT

- Press **[OK]**.
<Instrument Station Data Setting>
is restored.
 - Press **[EDIT]** to edit the coordinate data that was read in. Editing does not affect the original coordinate data. After editing, the point number is no longer displayed.



- The point number that was read in is displayed until the current JOB is changed.
- When **[SEARCH]** is pressed, SCT searches data in the current JOB first, then in the Coordinate Search JOB.
- If more than two points with the same point name exist in the current JOB, SCT finds the newer data only.

12.2 Setting Azimuth Angle Setting from Backsight Coordinates

Set the azimuth angle of the backsight station by inputting the angle or calculating from the coordinates.

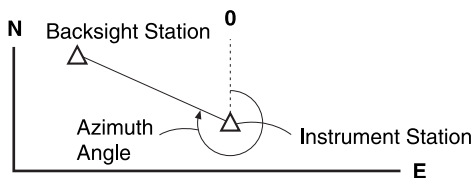

► PROCEDURE

- Enter the instrument station data.
 "12.1 Entering Instrument Station Data and Azimuth Angle" steps 1 to 3

2. Press **[BS COORD]** to proceed to backsight coordinate input.

```

NO: 0-00-0
EO: 0-00-0
ZO: 0-00-0
Pt. 100
Inst. HT 42-00-1/4
LIST BSANGLE BSCCOORD EDIT

```

3. Input the backsight coordinates and press **[OK]**. Angle measurement values are displayed in real time. Calculated azimuth angle is also also displayed.

```

Backsight
NBS: 561-00-0
EBS: 1551-00-0
ZBS: 330-00-0
LIST EDIT OK

```

- Press **[DIST]** to perform a horizontal distance check.

```

Backsight
Shoot Backsight
ZA 90°12'34"
HAR 123°12'34"
Azimuth 45°00'00"
RECORD DIST NO YES

```

- Press **[HT]** to set instrument and target height.
- Press **[REC]** to store check data in the current JOB

```

BS Hdist check
calc H 0-00-0
obs H 0-04-7/8
dH 0-00-0
RECORD INSTR / ROD HT OK

```

- When you wish to read in the registered coordinate data, press **[LIST]**.

☞ "12.1 Entering Instrument Station Data and Azimuth Angle PROCEDURE Reading in Registered Coordinate Data"

```

S 0-04-7/8
ZA 90°00'00"
HAR 30°00'00"
Cd
Rod HT 0-04-7/8
OK ADD LIST EDIT

```

4. Press **[YES]** in the screen of step 3 to set azimuth angle. <Coordinate Menu> is displayed again.

12. COORDINATE MEASUREMENT

- When storing the azimuth angle in the current JOB, press **[RECORD]**.
-  21.2 Recording Backsight Point, PROCEDURE Inputting azimuth angle".

12.3 3-D Coordinate Measurement

The coordinate values of the target can be found by measuring the target based on the settings of the instrument station and backsight station.

The coordinate values of the target are calculated using the following formulae.

$$N1 \text{ Coordinate} = N0 + S \times \sin Z \times \cos Az$$

$$E1 \text{ Coordinate} = E0 + S \times \sin Z \times \sin Az$$

$$Z1 \text{ Coordinate} = Z0 + S \times \cos Z + ih - fh$$

N0: Station point N coordinate S: Slope distance ih: Instrument height
E0: Station point E coordinate Z: Zenith angle fh: Rod height
Z0: Station point Z coordinate Az: Direction angle

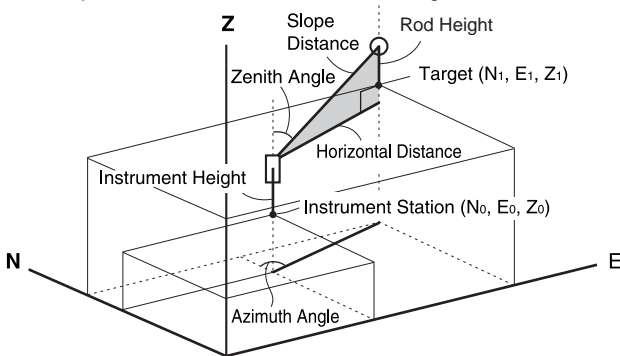

► PROCEDURE

1. Sight the target at the target point.
2. In <Coordinate Menu>, select "Take a Shot" to start measurement. The coordinate value of the target is displayed. Press **[STOP]** to quit measurement.

```
Coordinate Menu
Setup Stn. & BS
Take a Shot
EDM Settings
```

- By pressing **[INSTR/ROD HT]**, the instrument station data can be reset. When the rod height of the next target is different, reenter the rod height before beginning the observation.

```
N      793-07-1/4
E      1123-10-1/4
Z      1008-11-3/4
ZA     89°42'50"
HAR    180°31'20"
TAKESHOT  INSTR /ROD HT RECORD
```

- **[RECORD]**: records measurement results
- ☞ Recording method:
"21. RECORDING DATA -
RECORD MENU -"

3. Sight the next target and press **[TAKESHOT]** to begin measurement. Continue until all targets have been measured.
4. When coordinate measurement is completed, press **{ESC}** to return to <Coordinate Menu>.

12.4 Coordinate Measurement and Outputting the Data

The following explains coordinate measurement and the features used to output measurement data to a computer or peripheral equipment.



Communication cables: "29.2 Optional Accessories"

Output format and command operations: "Interfacing with the SOKKIA SDR Electronic Field Book" and "Command Explanations" manuals

►PROCEDURE

1. Connect SCT and host computer.
2. Allocate the **[STREAM-DATAOUT]** softkey to the Meas mode screen.
 "25.2 Allocating Key Functions"
3. Sight the target point.
4. Press **[STREAM-DATAOUT]**, and select "Coord Data" to output measurement data.
5. Press **[STOP]** to stop outputting data and return to Meas Mode

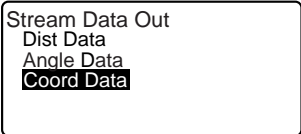

Stream Data Out
Dist Data
Angle Data
Coord Data

13. RESECTION MEASUREMENT

Resection is used to determine the coordinates of an instrument station by performing multiple measurements of points whose coordinate values are known. Registered coordinate data can be recalled and set as known point data. Residual of each point can be checked, if necessary.

Entry

Output

Coordinates of known point : (X_i, Y_i, Z_i) Station point coordinates : (X_0, Y_0, Z_0)
Observed horizontal angle : H_i
Observed vertical angle : V_i
Observed distance : D_i

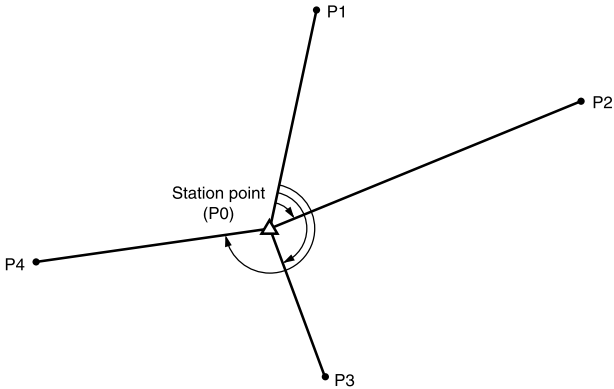

- All the N, E, Z or only Z data of an instrument station is calculated by measuring the known points.
- Coordinate resection measurement overwrites the N, E and Z data of the instrument station, but height resection does not overwrite N and E. Always perform resection measurement in the sequence described in “13.1 Coordinate Resection Measurement” and “13.2 Height Resection Measurement”.
- Input known coordinate data and calculated instrument station data can be recorded in the current JOB.

 “22. SELECTING/DELETING A JOB”

13. RESECTION MEASUREMENT

13.1 Coordinate Resection Measurement

N, E, Z of an instrument station is determined by the measurement.

- Between 2 and 10 known points can be measured by distance measurement, and between 3 and 10 known points by angle measurement.

►PROCEDURE

1. Allocate the **[RESEC]** softkey to the Meas mode screen.
☞ “25.2 Allocating Key Functions”
2. Press **[RESEC]** to begin resection measurement.
3. Select “NEZ” and press **[EDIT]** to input the known point.
After setting the coordinates for the first known point press **{▶}** to move to the second point.
When all required known points have been set, press **[MEAS]**.

	2nd Pt.	▶▶
Np:	330-00-0	
Ep:	330-00-0	
Zp:	165-00-0	
Rod HT	3-11-1/4	
1	2	3 4

- When **[LIST]** is pressed, registered coordinates can be recalled and used.

☞ “12.1 Entering Instrument Station Data and Azimuth Angle PROCEDURE Reading in Registered Coordinate Data”

- Press **{◀}** to return to the previous known point.
4. Sight the first known point and press **[DIST]** to begin measurement.
The measurement results are displayed on the screen.

Resection	1st Pt.
N	330-00-0
E	330-00-0
Z	165-00-0
[DIST]	[ANGLE]

13. RESECTION MEASUREMENT

- When **[ANGLE]** has been selected, the distance cannot be displayed.

5. Press **[YES]** to use the measurement results of the first known point.

Resection	1st Pt.
H	1733-09-3/4
ZA	80°30'15"
HAR	120°10'00"
Rod HT	3-11-1/3
EDIT NO YES	

- You can also input rod height here.

6. Repeat procedures 4 to 5 in the same way from the second point. When the minimum quantity of observation data required for the calculation is present, **[CALC]** is displayed.

7. Press **[CALC]** or **[YES]** to automatically start calculations after observations of all known points are completed. Instrument station coordinate and standard deviation, which describes the measurement accuracy, are displayed.

Resection	3rd Pt.
H	375-01-3/4
ZA	40°30'15"
HAR	20°10'00"
Rod HT	03-01-1/2
CALC EDIT NO YES	

8. Press **[RESULT]** to check the result.
If there are no problems with the result, press **{ESC}** and go to step 11.

N	330-00-1/4
E	330-00-0
Z	329-11-3/4
σN	0-00-1/4
σE	0-00-1/8
RESULT RECORD OK	

- **[RECORD]**: records measurement results

 Recording method:
"21. RECORDING DATA - RECORD MENU -"

- Press **[ADD]** when there is a known point that has not been measured or when a new known point is added.

	σN	σE
1st	-0.001	0.001
* 2nd	0.005	0.010
3rd	-0.001	0.001
4th	-0.003	-0.002
BAD RE.CALC REDOSHOT ADD		

13. RESECTION MEASUREMENT

9. If there are problems with the results of a point, align the cursor with that point and press **[BAD]**. “*” is displayed on the left of the point. Repeat for all results that include problems.

10. Press **[RE CALC]** to perform calculation again without the point designated in step 9. The result is displayed.

If there are no problems with the result, go to step 11.

If problems with the result occur again, perform the resection measurement from step 4.

- Press **[REDO SHOT]** to measure the point designated in step 9.

If no points are designated in step 9, all the points or only the final point can be observed again.



Resection
Start Point
Last Point

11. Press **[OK]** to finish resection measurement. The instrument station coordinate is set. Press **[YES]** when you want to set the azimuth angle of the first known point as the backsight point.

- Press **[NO]** to return to Meas Mode without setting the azimuth angle.



- It is also possible to perform resection measurement when **[MENU]** on page 2 of the Meas mode screen is pressed, then “Resection” is selected without allocating the function key.
- Even if “inch” is selected in SETTINGS mode, standard deviation is displayed in “feet” or “US feet” depending on the feet unit selected.

13.2 Height Resection Measurement

Only Z (height) of an instrument station is determined by the measurement.

- Known points must be measured by distance measurement only.
- Between 1 and 10 known points can be measured.

►PROCEDURE

1. Press **[RESEC]** when allocated to the Meas Mode screen to begin resection measurement.
2. Select "Elevation" and press **[EDIT]** to input the known point. After setting the elevation for the first known point, press **[▶]** to move to the second point. When all required known points have been set, press **[MEAS]**.

- Press **[◀]** to return to the previous known point.

10th Pt.

Zp: 39 03 1 4

Rod HT 0-03-3/4

1 2 3 4

Resection 10th Pt.

Z 39-03-1/4

TAKESHOT

3. Sight the first known point and press **[TAKESHOT]** to begin measurement. The measurement results are displayed on the screen.
4. Press **[YES]** to use the measurement results of the first known point.
5. If measuring two or more known points, repeat procedures 3 to 4 in the same way from the second point. When the minimum quantity of observation data required for the calculation is present, **[CALC]** is displayed.

13. RESECTION MEASUREMENT

6. Press **[CALC]** or **[YES]** to automatically start calculations after observations of all known points are completed. Instrument station elevation and standard deviation, which describes the measurement accuracy, are displayed.



Z 33-00-0
 σZ 0-01-3/4
RESULT RECORD OK

7. Press **[RESULT]** to check the result.
If there are no problems in the result, press **{ESC}** and go to step 10.

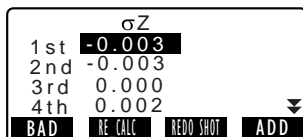

σZ
1st -0.003
2nd -0.003
3rd 0.000
4th 0.002
BAD RE-CALC REDO SHOT ADD

8. If there are problems with the results of a point, align the cursor with that point and press **[BAD]**. “*” is displayed on the left of the point.

9. Press **[RE CALC]** to perform calculation again without the point designated in step 8. The result is displayed.

If there are no problems with the result, go to step 10.

If problems with the result occur again, perform the resection measurement from step 3.

10. Press **[OK]** to finish resection measurement. Only Z (elevation) of the instrument station coordinate is set. N and E values are not overwritten.



Resection calculation process

The NE coordinates are found using angle and distance observation equations, and the instrument station coordinates are found using the method of least squares. The Z coordinate is found by treating the average value as the instrument station coordinates.

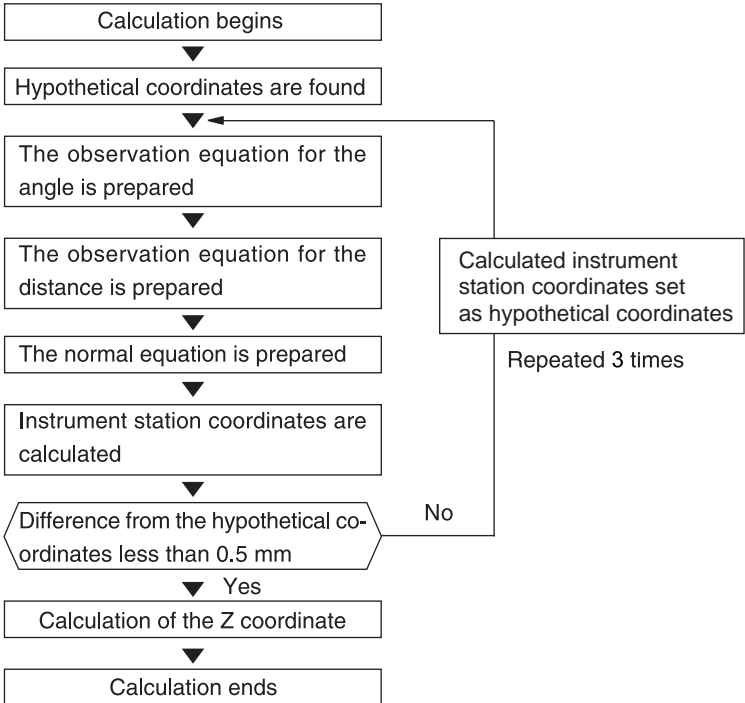

13. RESECTION MEASUREMENT



Precaution when performing resection

In some cases it is impossible to calculate the coordinates of an unknown point (instrument station) if the unknown point and three or more known points are arranged on the edge of a single circle.

An arrangement such as that shown below is desirable.

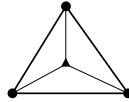

△▲ : Unknown point

○● : Known point

It is sometimes impossible to perform a correct calculation in a case such as the one below.

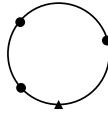

When they are on the edge of a single circle, take one of the following measures.

- (1) Move the instrument station as close as possible to the center of the triangle.

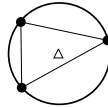

- (2) Observe one more known point which is not on the circle.

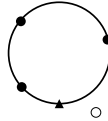

- (3) Perform a distance measurement on at least one of the three points.

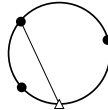

- In some cases it is impossible to calculate the coordinates of the instrument station if the included angle between the known points is too small. It is difficult to imagine that the longer the distance between the instrument station and the known points, the narrower the included angle between the known points. Be careful because the points can easily be aligned on the edge of a single circle.

14. STAKEOUT MEASUREMENT

Stakeout measurement is used to stake out the required point.

The difference between the previously input data to the instrument (the stakeout data) and the measured value can be displayed by measuring the horizontal angle, distance or coordinates of the sighted point.

The horizontal angle difference and distance difference are calculated and displayed using the following formulae.

Horizontal angle difference

dHA = Horizontal angle of stakeout data - measured horizontal angle

Distance difference

Distance Displayed item

Sdist: S-O S =measured slope distance - slope distance of stakeout data

Hdist: S-O H =measured horizontal distance - horizontal distance of stakeout data

Vdist: S-O V =measured height difference - height difference of stakeout data

- Stakeout data can be input in various modes: coordinates, horizontal distance, slope distance, height difference, and REM measurement.
- In coordinate, horizontal distance, slope distance, and height difference mode, registered coordinates can be recalled and used as stakeout coordinates. In horizontal distance, slope distance and height difference, S/H/V distances are calculated from the read in stakeout coordinate, instrument station data, instrument height, and rod height.

14.1 Coordinates Stakeout Measurement

After setting the coordinates for the point to be set out, the SCT calculates the stakeout horizontal angle and horizontal distance. By selecting the horizontal angle and/or the horizontal distance stakeout functions, the required coordinate location can be set out.

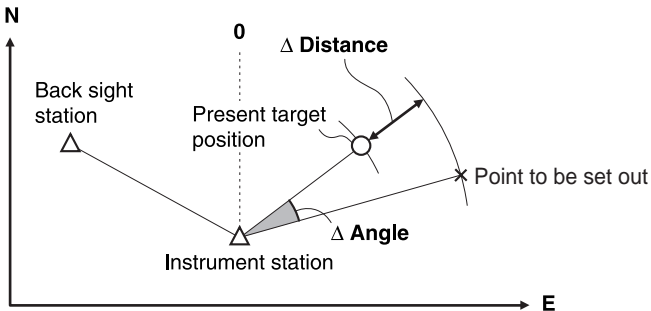

14. STAKEOUT MEASUREMENT

- To find the Z coordinate, attach the target to a pole etc. with the same rod height.

►PROCEDURE

1. Press **[STAKEOUT]** on the first page of the Meas mode screen to display <Stakeout Menu>.

2. Enter the instrument station data.
☞ "12.1 Entering Instrument Station Data and Azimuth Angle PROCEDURE Reading in Registered Coordinate Data"

3. Set the azimuth angle of the backsight point.
☞ "12.2 Setting Azimuth Angle Setting from Backsight Coordinates" steps 2 to 6

4. Select "Stakeout data".

5. Press **[EDIT]**. Enter the coordinates of the stakeout point.

- When **[LIST]** is pressed, registered coordinates can be recalled and used as stakeout coordinates.

- ☞ "12.1 Entering Instrument Station Data and Azimuth Angle PROCEDURE Reading in Registered Coordinate Data"

6. Press **[OK]** to set the stakeout data.

7. Rotate the top of the instrument until "dHA" is 0° and place the target on the sight line.

Stakeout Menu Coord			
Np:	330-00-0		
Ep:	330-00-0		
Zp:	165 00 0		
Rod HT	0-42-1/2		
1	2	3	4

8. Press **[TAKESHOT]** to begin coordinate stakeout measurement.

9. The direction (left/right, in/out, fill/cut) in which the target should be moved is displayed. When the target is within measurement range, no direction is displayed. Fill: Move the prism upward. Cut: Move the prism downward.

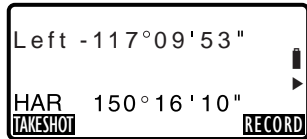

- Press **[▶]** to switch to Normal mode. Press **[◀]** to return to Simple mode.

- Press **[▲]** to switch to <S-OΔ>.

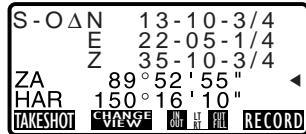
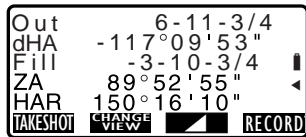

10. Press **{ESC}** to return to <Stakeout Menu>.
 - When **[LIST]** was used in step 5, the list of registered coordinates is restored. Continue stakeout measurement.
 - **[RECORD]** : records measurement results.

- Recording method:
 "21. RECORDING DATA - RECORD MENU -

- "Unknown Setup" in <Stakeout Menu> is for coordinate resection measurement when limited to only 2 known points
[F] "13.1 Coordinate Resection Measurement".

14. STAKEOUT MEASUREMENT

14.2 Distance Stakeout Measurement

The point to be found based on the horizontal angle from the reference direction and the distance from the instrument station.

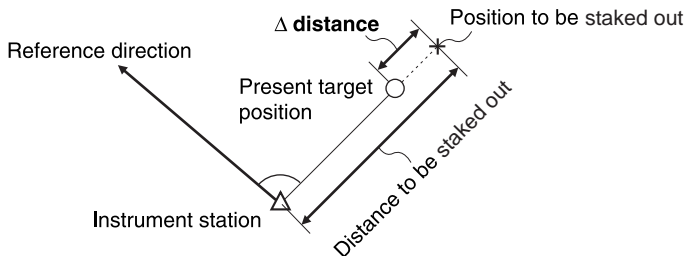

► PROCEDURE

1. Press **[STAKEOUT]** in the first page of the Meas mode screen to display <Stakeout Menu>.
2. Enter the instrument station data.
☞ "12.1 Entering Instrument Station Data and Azimuth Angle PROCEDURE Reading in Registered Coordinate Data"
3. Set the azimuth angle of the backsight point.
☞ "12.2 Setting Azimuth Angle Setting from Backsight Coordinates" steps 2 to 6.
4. Select "Stakeout Data".

5. Press **[CHANGE VIEW]** to select distance input mode.
 Each time **[CHANGE VIEW]** is pressed: Stakeout Menu Coord (coordinates), Stakeout Menu H (horizontal distance), Stakeout Menu S (slope distance), Stakeout Menu V (height difference), Stakeout Menu Ht. (REM measurement).

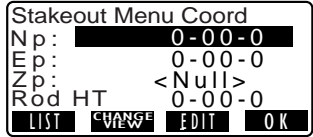

"14.1 Coordinates Stakeout Measurement", "14.3 REM Stakeout Measurement"

6. Press **[CHANGE VIEW]** until <Stakeout Menu H> is displayed.
- When **[LIST]** is pressed, registered coordinates can be recalled and used. Distance and angle are calculated using the coordinate value.

"12.1 Entering Instrument Station Data and Azimuth Angle PROCEDURE Reading in Registered Coordinate Data"

7. Press **[EDIT]** and set the following items.

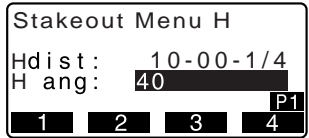

- (1) Hd ist/Sdist/Vdist: distance from the instrument station to the position to be set out.
- (2) H ang: included angle between the direction of the reference and the point to be set out.

- Pressing **[COORD]** in the second page allows you to enter the coordinates of the point to be set out.

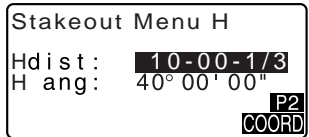

14. STAKEOUT MEASUREMENT

- Press **[OK]** to set the input values.
- Rotate the top of the instrument until "dHA" is 0° and place the target on the sight line.

- Press **[TAKESHOT]** to start distance measurement. The target and the distance of the point to be set out is displayed.

Out	-0-00-1/2
Left	-0-00-7/8
Cut	0-00-7/8
ZA	75°20'30"
HAR	39°05'20"

STOP

- Move the prism to find the point to be set out.

- Press **{◀}** to switch to Simple mode. Press **{▶}** to return to Normal mode.

- Press **{ESC}** to return to <Stakeout Menu>.

- When **[LIST]** was used in step 5, the list of registered coordinates is restored. Continue stakeout measurement.

- [RECORD]**: records measurement results

 Recording method:

"21. RECORDING DATA - RECORD MENU -"

14.3 REM Stakeout Measurement

To find a point where a target cannot be directly installed, perform REM stakeout measurement.

 "11.4 REM Measurement"

►PROCEDURE

1. Install a target directly below or directly above the point to be found, then use a measuring tape etc. to measure the rod height (height from the surveying point to the target).
2. Press **[STAKEOUT]** in the Meas mode screen to display <Stakeout Menu>.
3. Enter the instrument station data.
 "12.1 Entering Instrument Station Data and Azimuth Angle PROCEDURE Reading in Registered Coordinate Data".
4. Select "Stakeout Data" and press **[CHANGE VIEW]** until <Stakeout Menu Ht.> is displayed.
5. Press **[EDIT]**.
Input height from the surveying point to the position to be set out in "SO dist".
6. After inputting the data, press **[OK]**.

Stakeout Menu Ht.			
Height: <input type="text" value="1200"/>			
<input type="button" value="1"/>	<input type="button" value="2"/>	<input type="button" value="3"/>	<input type="button" value="4"/>

14. STAKEOUT MEASUREMENT

7. Press **[REMOTE ELEV]** to begin REM stakeout measurement. Move the telescope to find the point to be set out.

 "14.1 Coordinates Stakeout Measurement" steps 9 to 10

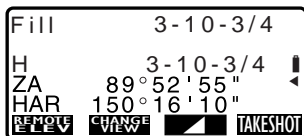

Fill : Move the telescope near the zenith.

Cut : Move the telescope near the nadir.

- Press **{◀}** to switch to Simple mode. Press **{▶}** to return to Normal mode.
8. When the measurement is completed, press **{ESC}** to restore <Stakeout Menu>.

15. STAKEOUT LINE

Stakeout line is used for setting out a required point at a designated distance from the baseline and for finding the distance from the baseline to a measured point.

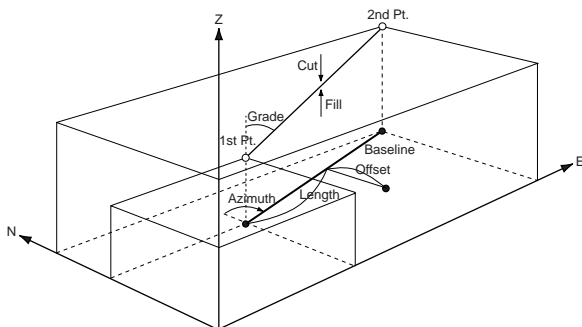

15.1 Defining Baseline

To perform stakeout line measurement, first, define the baseline. The baseline can be defined by inputting the coordinates of the two points. The scale factor value is the difference between the input coordinates and the observed coordinates.

$$\text{Scale (X, Y)} = \frac{\text{Hdist}' \text{ (horizontal distance calculated from the measured value)}}{\text{Hdist} \text{ (horizontal distance calculated from the input coordinates)}}$$

- When not observing first or second points, scale factor is set to "1".
- Defined baseline can be used in both stakeout line measurement and point projection.

► PROCEDURE

1. Allocate the **[STAKEOUT LINE]** softkey to the Meas mode screen.
☞ "25.2 Allocating Key Functions"
2. Press **[STAKEOUT LINE]** to display <Stakeout Line Menu>.

15. STAKEOUT LINE

3. Enter the instrument station data.
☞ “12.1 Entering Instrument Station Data and Azimuth Angle PROCEDURE Reading in Registered Coordinate Data”

4. Select “Define Baseline” in <Stakeout Line Menu> and press **[EDIT]**.

- When **[LIST]** is pressed, registered coordinates can be recalled and used.

- ☞ “12.1 Entering Instrument Station Data and Azimuth Angle PROCEDURE Reading in Registered Coordinate Data”

5. Enter the first point data and press **{←}**.

6. Press **{▶}** to move to the second point.

7. Press **[EDIT]** and enter the second point data.

8. Press **{FUNC}**.
[MEAS] is displayed.

- When not observing the first point and the second point, go to step 14.

Define 1st Pt. ▶▶			
Np:	374	05	1 4
Ep:	300-06-0		
Zp:	40-00-1/4		
1	2	3	4

◀ Define 2nd Pt.			
Np:	371	11	3/4
Ep:	343-05-3/4		
Zp:	38-10-3/4		
Pt.	2	P1	
LIST	RECORD	EDIT	OK

◀ Define 2nd Pt.			
Np:	371	11	3/4
Ep:	343-05-3/4		
Zp:	38-10-3/4		
Pt.	2	P2	
			MEAS

9. Press **[MEAS]** to move to observation of the first point.

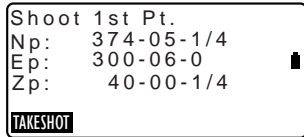

10. Sight the first point and press **[TAKESHOT]**.
 The measurement results are displayed on the screen.

- Press **[STOP]** to stop the measurement.
- You can input rod height here.

11. Press **[YES]** to use the measurement results of the first point.

- Press **[NO]** to observe the first point again.

12. Sight the second point and press **[TAKESHOT]**.

13. Press **[YES]** to use the measurement results of the second point.
 The distance between the two measured points, the distance calculated from inputting the coordinates of two points and the scale factors are displayed.

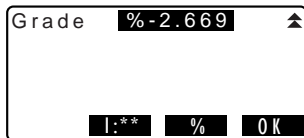
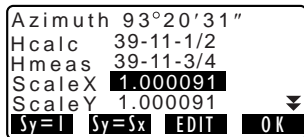

15. STAKEOUT LINE

14. Press **[OK]** to define the baseline.
<Stakeout line> is displayed.

Move to stakeout line measurement.

 "15.2 Stakeout Line Point"/
"15.3 Stakeout Line Line"

Stakeout Line Menu
Point
Line

- Press **[Sy=1]** to set scale factor y to "1".
- Press **[1 : **]** to change the grade display mode to "1 : * * = elevation : horizontal distance".

Note

- It is also possible to perform stakeout line measurement when **[MENU]** on page 2 of the Meas mode screen is pressed, then "Stakeout Line" is selected without allocating the function key.

15.2 Stakeout Line Point

Stakeout line point measurement can be used to find the required point coordinate by inputting the length and offset based on the baseline.

- Before performing stakeout line point, the baseline must be defined.

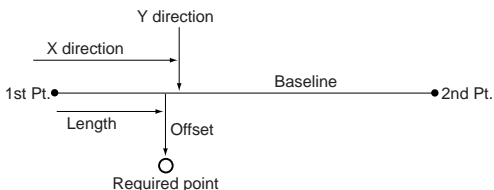

►PROCEDURE

1. Select "Point" in <Stakeout Line Menu>

2. Press **[EDIT]**.

Set the following items.

- (1) Length: Distance along the baseline from the first point to the position at which a line extending from the required point intersects the baseline at right angles (X direction).
- (2) Offset: Distance from the required point to the position at which a line extending from the required point intersects the baseline at right angles (Y direction).

Stakeout Line Menu			
Length	8 06 1 2		
Offset	4-03-1/4		
1	2	3	4

3. Press **[OK]**. The coordinate value of the required point is calculated and displayed.

- **[RECORD]**: records the coordinate value as a known point data.

 Recording method:
"23.1 Registering/Deleting
Known Point Data"

- Press **[STAKEOUT]** to move to stakeout measurement of the required point.

 "14. STAKEOUT
MEASUREMENT"

Stakeout Line Menu	
N	368-11-1/2
E	312-05-3/4
Z	39-08-3/4
RECORD	STAKEOUT

4. Press **{ESC}**. Continue the measurement (repeat steps from 4).

15.3 Stakeout Line Line

Stakeout line line measurement tells how far horizontally the measured point is from the baseline and how far vertically the measured point is from the connected line. The baseline can be offset in a horizontal direction if necessary.

15. STAKEOUT LINE

- Before performing stakeout line line, the baseline must be defined.

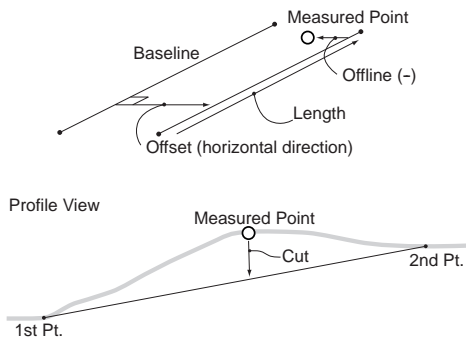

►PROCEDURE

1. Select "Line" in <Stakeout Line Menu>.
2. Press **[EDIT]** and enter the offset value.
 - Offset: How much to move the baseline.
A positive value indicates right side and a negative value indicates left side.
 - When not setting offset value, go to step 3.
3. Sight the target and press **[TAKESHOT]**.
The measurement results are displayed on the screen.
Press **[STOP]** to stop the measurement.
4. Press **[NO]** to observe the target again.

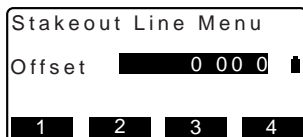

5. Press **[YES]** to use the measurement results.
Displays the difference between the measured point and the baseline.

Stakeout Line Menu	
Offline	-0-00-1/4
Cut	-0-00-1/4
Length	39-09-1/4
<div style="display: flex; justify-content: space-around;"> RECORD TAKESHOT </div>	

- Offline: A positive value indicates the point is on the right of the baseline and a negative value indicates it is on the left.
 - "Cut" indicates that the point is below the baseline.
 - "Fill" indicates that the point is above the baseline.
 - Length: Distance along the baseline from the first point to the measured point.
6. Sight the next target and press **[TAKESHOT]** to continue the measurement.
- Press **[RECORD]**: records measurement results.
-  Recording method:
"21. RECORDING DATA - RECORD MENU -"

16. SETTING-OUT ARC

This mode allows the operator to define an arc from various arc parameters, such as From Pt. coordinates, and set out this arc as well as points (offsets) along it.

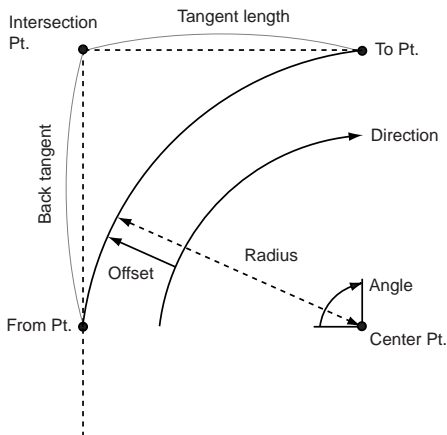

16.1 Defining an Arc

An arc can be defined by entering arc parameters such as arc radius, angle, coordinates for the From point, Center point, To point etc.

► PROCEDURE

1. Allocate the **[S-O ARC]** softkey to the Meas mode screen.
2. Press **[S-O ARC]**, then select "Setup Stn. Coord."
3. Enter the instrument station data.
☞ "12.1 Entering Instrument Station Data and Azimuth Angle PROCEDURE Reading in Registered Coordinate Data"

```
Set-out arc
Setup Stn. Coord.
Define arc
Set-out arc
```

4. Select "Define arc" in <Set-out arc>.
- When **[LIST]** is pressed, registered coordinates can be recalled and used.
-  "12.1 Entering Instrument Station Data and Azimuth Angle PROCEDURE Reading in Registered Coordinate Data"

```
Set-out arc
Setup Stn. Coord.
Define arc
Set-out arc
```

```
From Pt.
Np: 0-00-00
Ep: 0-00-00
Zp: 0-00-00
LIST RECORD EDIT OK
```

5. Enter the arc From point data and press **[OK]**.
6. Press **[▶]**/**[◀]** to select coordinates then press **[OK]**.

```
Select Pt.
To
OK
```

```
Select Pt.
Center/Intersect
OK
```

To : Enter arc To point.

To/Center : Enter arc To point and Center point.

To/Intersect : Enter arc To point and Intersect point (intersection of the tangents).

Center : Enter arc Center point.

Intersect : Enter arc Intersect point.

Center/Intersect: Enter arc Center point and Intersect point (intersection of the tangents).

7. Enter the coordinates specified in step 5 then press **[▶]**.
- When entering multiple coordinates, the right arrow is displayed.

```
To Pt.
Np: 0-00-00
Ep: 0-00-00
Zp: 0-00-00
LIST RECORD EDIT OK
```

16. SETTING-OUT ARC

8. Enter other arc parameters.

- (1) Direction (whether the arc turns right/left from the From point)
- (2) Radius (radius of the arc)
- (3) Angle (subtended angle)
- (4) Arc (distance along the arc)
- (5) Chord (straight line distance between the From and To points)
- (6) Tan In (tangent length)
- (7) Bk tan (back tangent length)

Direction:	Left
Radius:	<Null>
Angle :	<Null>
Arc :	<Null>
Chord :	141-04-1/2
OK	

Tan In:	<Null>	▲
Bk tan:	<Null>	
EDIT OK		



Parameters that can be entered may be restricted depending on the coordinates specified in step 5.



"Specifying coordinates and curve parameters"

9. Enter curve parameters then press **[←]**. Other parameters will be calculated.

Direction:	Right
Radius :	100-00-0
Angle :	90°00'00"
Arc :	157-08-0
Chord :	141-04-1/2
OK	

10. Press **[OK]** on the screen of step 8 to define the arc. <Set-out arc> is displayed. Move to setting-out arc measurement.



"16.2 Setting-out Arc" step 2

Note

- It is also possible to perform setting-out arc measurement by pressing **[S-O ARC]** when allocated to the Meas mode screen.



Allocating **[S-O ARC]**: "25.2 Allocating Key Functions"



Specifying coordinates and curve parameters

Parameters that can be entered may be restricted depending on the coordinates specified in step 5. Parameters that can be entered are marked with a circle (○). Those that cannot are marked with a cross (×).

Parameters \ Set coord	Radius	Angle	Arc	Chord	Tan In	Bk tan	Directi on
To pt Center pt	×	×	×	×	×	×	○
To pt Intersect pt	×	×	×	×	×	×	○
Center pt Intersect pt	×	×	×	×	×	×	○
To pt	○	○	○	×	○	○	○
Center pt	×	○	○	○	○	×	○
Intersect pt	○	○	×	○	×	×	○



Precaution when performing setting-out arc

In the following cases parameters cannot be calculated:

when Radius < $\frac{\text{Chord}}{2}$

When Arc < Chord

When Tan In × 2 < Chord

When the included angle between the back tangent and the azimuth angle between the From Pt. and To Pt is 0°, or exceeds 180°.

16.2 Setting-out Arc

Setting-out arc measurement can be used to find the coordinates of required points along the arc by inputting the arc (or chord) length and offset based on the arc.

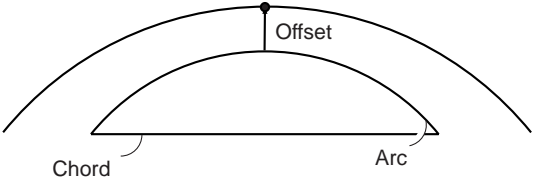

- Before performing setting-out arc, the arc must be defined.

►PROCEDURE

1. Select "Set-out arc" in <Set-out arc>.
2. Set the following items.
 - (1) Arc: Distance along the defined arc from the From point to the required point.
 - (1)' Chord: Distance along the chord of the defined arc from the From point to the required point.
 - (2) Offset: Distance from the required point to the position on a curve parallel to the original defined arc. A positive value indicates an offset arc to the right, and a negative value indicates an arc to the left.

```

Set-out arc
Setup Stn. Coord.
Define arc
Set-out arc
    
```

```

Set-out arc
Arc : 20-09-5/8
Offset : 0-03-0
[CHORD] [EDIT] [OK]
    
```

- Press **[CHORD]** to switch to Chord input.

Set-out arc	
Chord :	0-00-0
Offset :	0-00-0
ARC	EDIT OK

3. Press **[OK]** on the screen of step 2. The coordinate value of the required point is calculated and displayed.

Set-out arc	
N	118-11-1/4
E	106-08-1/4
Z	12-05-1/2
RECORD	▲S-0

- **[RECORD]**: records the coordinate value as a known point data.  Recording method: "23.1 Registering/Deleting Known Point Data"
- Press **[▲S-O]** to move to setting-out measurement of the required point.

 "14. STAKEOUT MEASUREMENT"

4. Press **{ESC}**. Continue the measurement (repeat steps from 2).

17. POINT PROJECTION

Point projection is used for projecting a point onto the baseline. The point to project can be either measured or input. Displays the distances from the first point and point to project to the position at which a line extending from point to project intersects the baseline at right angles.

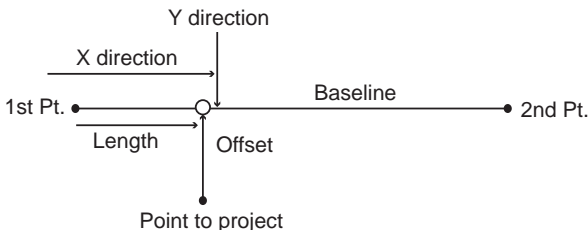

17.1 Defining Baseline

- Defined baseline can be used in both stakeout line measurement and point projection.

►PROCEDURE

1. Allocate the **[PT.PROJ]** softkey to the Meas mode screen.
☞ “25.2 Allocating Key Functions”
2. Press **[PT.PROJ]** to display <Point Proj. Menu>.
3. Enter the instrument station data then define the baseline.
☞ “15.1 Defining Baseline” steps 3 to 14
4. Press **[OK]** to define the baseline. <Point Proj. Menu> is displayed. Move to point projection measurement.
☞ “17.2 Point Projection”

Point Proj. Menu	
Np:	341-07-1/2
Ep:	334-07-3/4
Zp:	40-01-1/4
	P1
LIST	TAKESHOT
EDIT	OK



- It is also possible to perform stakeout line measurement when **[MENU]** on page 2 of the Meas mode screen is pressed, then “Point Projection” is selected without allocating the function key.

17.2 Point Projection

Before performing point projection, the baseline must be defined.

► PROCEDURE

- Define the baseline.
 “17.1 Defining Baseline”
- Press **[PT.PROJ]** to display <Point Proj. Menu>.
- Press **[EDIT]**, enter the point coordinate.

- Press **[TAKESHOT]** to observe the point to project.
- When recording the data as a known point, press **{FUNC}**, and then press **[RECORD]** on the second page.

Recording method:
 “23.1 Registering/Deleting Known Point Data”

- Press **[OK]**.
 The following items are calculated and displayed.

- Length: Distance along the baseline from the first point to the projected point (X direction).

Point Proj. Menu			
Np:	341-07-1/2		
Ep:	334-07-3/4		
Zp:	40-01-1/4		
			P1
1	2	3	4

Point Proj. Menu	
Length	31-00-1/4
Offset	27-11-0
d.Elev	01-01-0
NEZ	RECORD
STAKEOUT	

17. POINT PROJECTION

- Offset: Distance from point to project to the position at which a line extending from point of project intersects the baseline at right angles. (Y direction).
- d.Elev: Elevation between the baseline and the projected point.
- Press **[NEZ]** to switch the screen display to coordinate values.
- Press **[RECORD]**: records the coordinate value as a known point data.



Recording method:

"23.1 Registering/Deleting
Known Point Data"

- Press **[STAKEOUT]** to move to stakeout measurement of the projected point.



"14. STAKEOUT
MEASUREMENT"

5. Press **{ESC}**. Continue the measurement (repeat steps from 3).

18.INTERSECTIONS

It is possible to find an intersection point between 2 reference points by specifying the length or azimuth angle of either point.

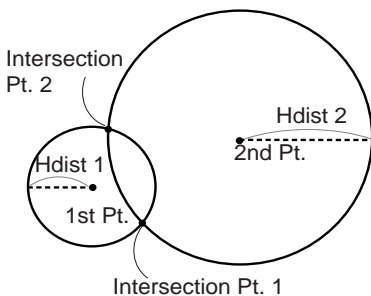
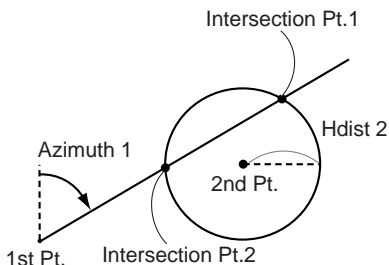

►PROCEDURE

1. Allocate the **[INTSCT]** softkey to the Meas mode screen.
2. Press **[INTSCT]**.
3. Enter the 1st point data and press **[NEXT]**.

Define 1st Pt.	
Np:	113-04-3/4
Ep:	91-08-0
Zp:	12-11-1/16
LIST	RECORD
EDIT	NEXT

18. INTERSECTIONS

- When **[LIST]** is pressed, registered coordinates can be recalled and used.
-  "12.1 Entering Instrument Station Data and Azimuth Angle PROCEDURE Reading in Registered Coordinate Data"
- [RECORD]**: records the coordinate value as a known point data.

rec 3991			
N	0 00 0		
E	0-00-0		
Z	0-00-0		
Pt.	5		
1	2	3	4

- Enter the 2nd point data and press **[OK]**.

Define 2nd Pt.	
Np:	112-07-1/4
Ep:	104-06-5/16
Zp:	11-07-0
[LIST]	[RECORD] [EDIT] [OK]

- Enter azimuth angle (or horizontal distance) of the 1st point and 2nd point.

Azmth1:	45°00'00"
H.dist1:	<Null>
Azmth2:	
H.dist2:	50-00-0
[COORD]	[EDIT] [OK]



Both the azimuth angle and horizontal distance of the 1st (or 2nd) point cannot be input.

- When the cursor is on "Azmth1" or "Azmth2", **[COORD]** is displayed. Press **[COORD]** to set the azimuth angle for each point by inputting coordinates.

1st Pt.	
Np:	0-00-0
Ep:	0-00-0
Zp:	<Null>
[LIST]	[RECORD] [EDIT] [NEXT]

6. Press **[OK]**. The coordinate value of the intersection point is calculated and displayed.

```
Azmth1 : 45° 00' 00"
H.dist1 : <Null>
Azmth2 : <Null>
H.dist2 : 50-00-0
      [EDIT] [OK]
```

```
Intersection1
N      176-04-5/8
E      176-04-5/8
Z      <Null>
[OTHER] [RECORD] [STAKEOUT]
```

- When there are 2 intersections, **[OTHER]** is displayed.

 "2 Intersections"

- Press **[STAKEOUT]** to move to setting-out measurement of the required point.

 "14. STAKEOUT MEASUREMENT"

7. Press **{ESC}**. Continue the measurement (repeat steps from 2).

Note

- It is also possible to perform intersection measurement by pressing **[INTSCT]** when allocated to the Meas mode screen.

 Allocating **[INTSCT]**: "25.2 Allocating Key Functions"



2 Intersections

2 intersections are defined according to 1st Pt. and 2nd Pt. as shown below
 Intersections created from Azmth 1 and H.dist 2 (or H.dist 1 and Azmth 2):
 An azimuth angle has already been set for a point. The furthest point from this point is set as Intersection Pt. 1, and the closest point set as Intersection Pt. 2.

- Intersections created from H.dist 1 and H.dist 2:
 Intersection to the right of the straight line between 1st point and 2nd point set as Intersection Pt. 1 and the point to the left set as Intersection Pt. 2.

18. INTERSECTIONS



Precaution when performing intersection measurement

In the following cases the coordinates of intersection points cannot be calculated.

When Azimuth 1 = Azimuth 2.

When Azimuth 1 – Azimuth 2 = $\pm 180^\circ$.

When H.dist 1 = 0, or H.dist 2 = 0.

When the coordinates for 1st Pt. and 2nd Pt are the same.

19. MISSING LINE MEASUREMENT

Missing line measurement is used to measure the slope distance, horizontal distance, and horizontal angle to a target from the target which is the reference (starting point) without moving the instrument.

- It is possible to change the last measured point to the next starting position.
- Measurement result can be displayed as the gradient between two points.

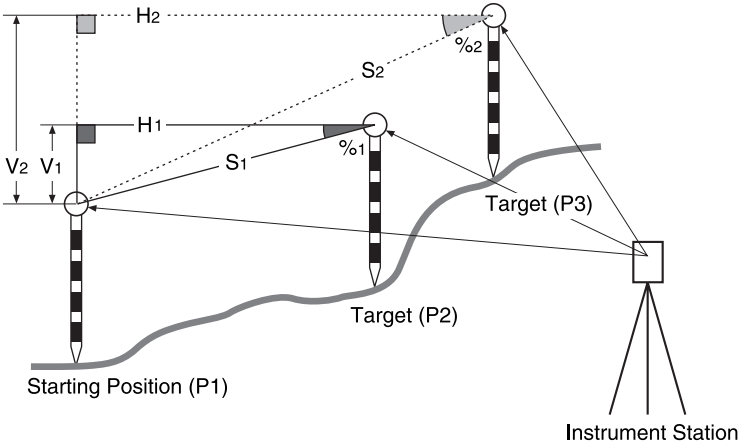

19.1 Measuring the Distance between 2 or more Points

The distance between two or more points can either be measured by observing the targets in question or calculating from input coordinates. A combination of these two methods (e.g. observing the 1st target and inputting 2nd target coordinates) is also possible.

19. MISSING LINE MEASUREMENT

►PROCEDURE Measuring using observation

1. Allocate the **[MISSING-LINE]** softkey to the Meas Mode screen.
2. Press **[MISSING-LINE]** then select "Missing Line".

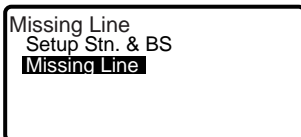

3. Sight the 1st target and press **[TAKESHOT]**.
 - **[RECORD]**: records 1st target measurement results.

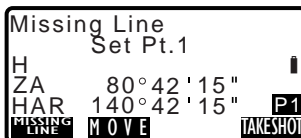

4. Sight the 2nd target and press **[MISSING-LINE]** to begin observation.

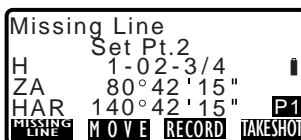

The following values are displayed:

S : Slope distance of the starting position and 2nd target.

H : Horizontal distance of the starting position and 2nd position.

V : Height difference of the starting position and 2nd target.

- Rod height of the starting position and second target can be input.

Press **[TARGET]** on the second page.

Input the rod heights and press **[OK]**.

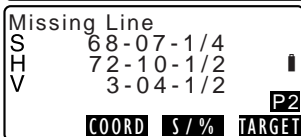
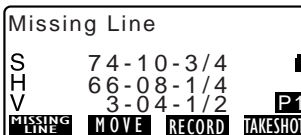

- Press **[COORD]** to input coordinates.
 "PROCEDURE
 Calculating from input
 coordinates"
- Press **[RECORD]** to record 2nd target measurement results and display the screen at right.

Press **[OK]** to record missing line measurement results and return to the results screen.

Press **{ESC}** to continue measurement without saving 2nd target or missing line measurement results.

N	10-00-0
E	20-00-0
Z	30-00-0
Cd	1010
Rod HT	8-00-0
OK ADD LIST EDIT	

H	0-11-3/8
V	0-11-3/8
Cd	1010
Pt.1	2
Pt.2	3
OK ADD LIST EDIT	

Missing Line	
S	0-11-5/8
H	0-11-3/8
V	0-11-3/8
P1	
MISSING LINE MOVE TAKESHOT	



- Missing line measurement results cannot be recorded when point names for 1st and/or 2nd target are null. Always input point names for both targets.

- Sight the next target and press **[MISSING-LINE]** to begin observation. Slope distance, horizontal distance and height difference between multiple points and the starting position can be measured this way.
 - When **[S/%]** is pressed, the distance between two points (S) is displayed as the gradient between two points.
 - Press **[TAKESHOT]** to re-observe the starting position. Sight the starting position and press **[TAKESHOT]**.

19. MISSING LINE MEASUREMENT

- When **[MOVE]** is pressed, the last target measured becomes the new starting position to perform missing line measurement of the next target.

 "19.2 Changing the Starting Point"

- Press **{ESC}** to end missing line measurement.

►PROCEDURE Calculating from input coordinates

- Allocate the **[MISSING-LINE]** softkey to the Meas mode screen.

- Press **[MISSING-LINE]** then select "Missing Line".

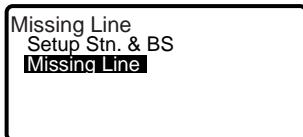

```
Missing Line
Setup Stn. & BS
Missing Line
```

- Press **[COORD]** on the second page.

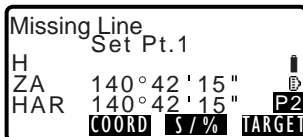

```
Missing Line
Set Pt. 1
H
ZA 140° 42' 15"
HAR 140° 42' 15" P2
COORD S/% TARGET
```

- Input coordinates for the 1st target and press **[OK]**.

- When you wish to read in and set coordinate data from memory, press **[LIST]**.

 "12.1 Entering Instrument Station Data and Azimuth Angle"

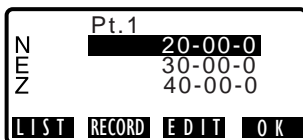

```
Pt. 1
N 20-00-0
E 30-00-0
Z 40-00-0
LIST RECORD EDIT OK
```

- Press **{←}** to proceed to 2nd target input.

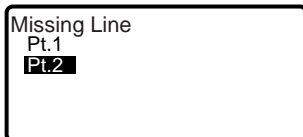

```
Missing Line
Pt. 1
Pt. 2
```

6. Input coordinates for the 2nd target and press **[OK]**.

The following values are displayed:

- S : Slope distance of the starting position and 2nd target.
 H : Horizontal distance of the starting position and 2nd position.
 V : Height difference of the starting position and 2nd target.

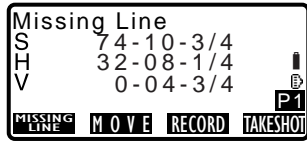

- Rod height of the starting position and 2nd target can be input.
 Press **[TARGET]** on the second page.

Input the target heights and press **[OK]**.

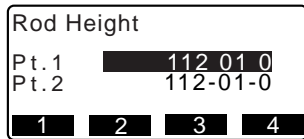

- Press **[COORD]** to re-input coordinates for the first or 2nd targets.
- [REC]**: records missing line measurement results.
- When **[S/%]** is pressed, the distance between two points (S) is displayed as the gradient between two points.
- Press **[TAKESHOT]** to observe the starting position.

 "PROCEDURE Measuring using observation"

19. MISSING LINE MEASUREMENT

- When **[MOVE]** is pressed, the last target measured becomes the new starting position to perform missing line measurement of the next target.

 "19.2 Changing the Starting Point"

Press **{ESC}** to end missing line measurement



- Missing line measurement results cannot be recorded when point names for 1st and/or 2nd target are null. Always input point names for both targets.

19.2 Changing the Starting Point

It is possible to change the last measured point to the next starting position.

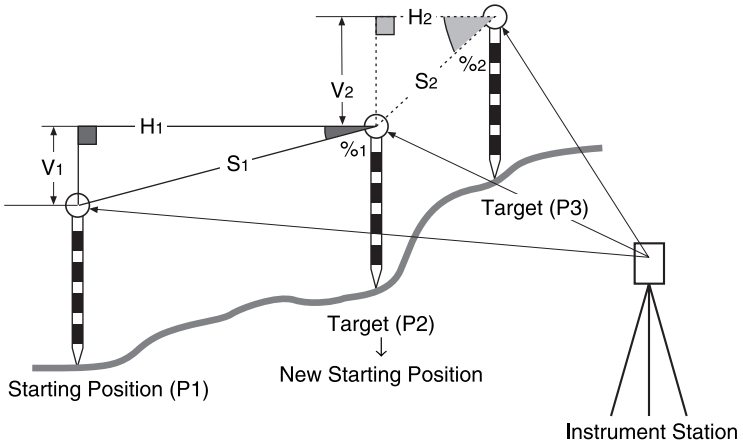

►PROCEDURE

1. Observe the starting position and target

 "19.1 Measuring the Distance between 2 or more Points"

2. After measuring the targets, press **[MOVE]**.
Press **[YES]**.

- Press **[NO]** to cancel measurement.

Missing Line		
S	74-10-3/4	
H	32-08-1/4	
V	0-04-3/4	P1
MISSING LINE	MOVE	TAKE SHOT

Missing Line		
Move 1st Shot?		
N	114-09-1/8	
E	85°50'30"	
Z	125°30'20"	
NO		YES

3. The last target measured is changed to the new starting position.
Perform missing line measurement
 "19.1 Measuring the Distance between 2 or more Points"

20. SURFACE AREA CALCULATION

You can calculate the area of land (slope area and horizontal area) enclosed by three or more known points on a line by inputting the coordinates of the points.

Input

Output

Coordinates: P1 (N1, E1, Z1) Surface area: S (slope area and horizontal area)

...
P5 (N5, E5, Z5)

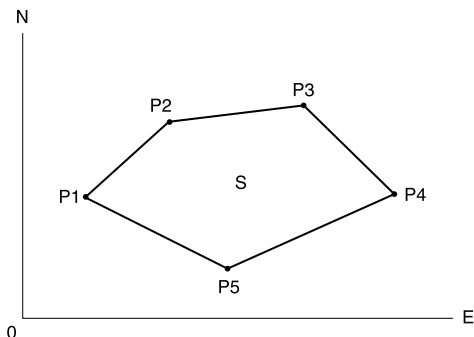

- Number of specified coordinate points: 3 or more, 50 or less
- Surface area is calculated by observing the points on a line enclosing an area in order or reading in the previously registered coordinates in order.





- If two or less points are used to measure an area, an error will occur.
- Be sure to observe (or recall) points on an enclosed area in a clockwise or counterclockwise direction. For example, the area specified by entering (or recalling) point numbers 1, 2, 3, 4, 5 or 5, 4, 3, 2, 1 implies the same shape. However, if points are not entered in numerical order, the surface area will not be calculated correctly.



Slope area

The first three points specified (measured/read-in) are used to create the surface of the slope area. Subsequent points are projected vertically onto this surface and the slope area calculated.

►PROCEDURE Surface area calculation by observing points

1. Allocate the **[AREA CALC]** softkey to the Meas mode screen.
 "25.2 Allocating Key Functions"
2. Enter the instrument station data.
 "12.1 Entering Instrument Station Data and Azimuth Angle PROCEDURE Reading in Registered Coordinate Data"
3. Press **[AREA CALC]** to begin surface area calculation.
4. Select "Area Calculation" in <Area Calc.>.

```
Area Calc.
Setup Stn. Coord.
Area Calculation
```

5. Sight the first point on the line enclosing the area, and press **[MEAS]**.
 Press **[TAKESHOT]** to begin observation.
 The measured values are displayed.

```
01:
02:
03:
04:
05:
LIST MEAS
```

- When **[LIST]** is pressed, registered coordinates can be recalled and used in subsequent measurements.

```
N 176-04-5/8
E 73-02-7/8
Z 1-11-1/4
ZA 90°01'25"
HAR 109°32'00"
OK RECORD TAKESHOT
```

-  "PROCEDURE Surface area calculation by reading in the points' coordinates"

```
01: Pt_01
02:
03:
04:
05:
MEAS
```

20. SURFACE AREA CALCULATION

- The **[LIST]** function allows all registered data to be calculated together.
 - Press **[RECORD]** to record code, rod height, and point number. The point number recorded here will be displayed in "01".
 - The **[TAKESHOT]** function requires each point to be observed individually before area calculation is performed.
6. Press **[OK]** to enter the value of the 1st point in "01".

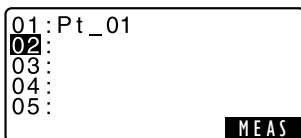

7. Repeat steps 5 to 6 until all points have been measured. Points on an enclosed area are observed in a clockwise or counterclockwise direction.

For example, the area specified by entering point numbers 1, 2, 3, 4, 5 or 5, 4, 3, 2, 1 implies the same shape.

After all known points necessary to calculate the surface area have been observed, **[CALC]** is displayed.

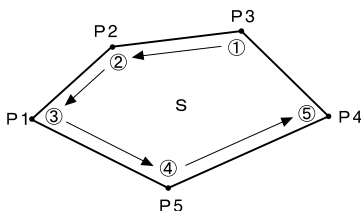

8. Press **[CALC]** to display the calculated area.
- Pt.: number of set points
SArea: slope area
HArea: horizontal area

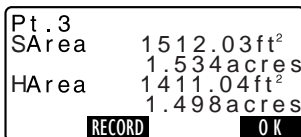

9. Press **[RECORD]** in the screen of step 8 to record results and return to Meas mode.
- Press **[OK]** to return to Meas mode without recording results.

► **PROCEDURE** Surface area calculation by reading in the points' coordinates

1.  "PROCEDURE Surface area calculation by observing points" steps 1 to 4

2. Press **[LIST]** to display the list of coordinate data.
 Pt. : Known point data saved in the current JOB.
 Crd./Stn : Coordinate data saved in the current JOB.

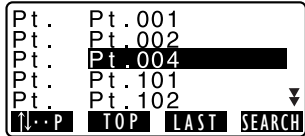

3. Select the first point in the list and press **{←}**.
 The coordinates of the first point is set as "Pt.001".

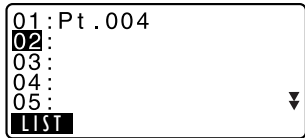

4. Repeat steps 2 to 3 until all points have been read in.
 Points on an enclosed area are read in a clockwise or counterclockwise direction.
 After all known points necessary to calculate the surface area have been observed, **[CALC]** is displayed.

5. Press **[CALC]** to display the calculated area.
 Pt.: number of set points
 SArea: slope area
 HArea: horizontal area

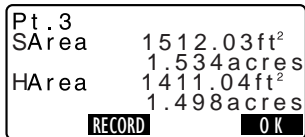
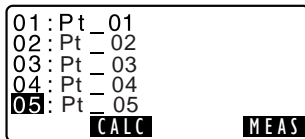

20. SURFACE AREA CALCULATION

6. Press **[RECORD]** in the second screen of Step 5 to record results and return to Meas Mode. Press **[OK]** to return to Meas mode without recording results.

21. RECORDING DATA - RECORD MENU -

In Jobs/Data menu, you can store the measurement data (distance, angle, coordinates), station point data, backsight station data, and note in the current JOB.

"22. SELECTING/DELETING A JOB"

- A total of 10000 data can be stored inside the instrument.

Note

- If the same point number is input, the following screen is displayed. Recording backsight station data is an exception.

N	18-04-1/2
E	2-05-3/4
Z	0-07-1/2
Pt.	PNT-001
	Overwrite ?
ADD	NO YES

Press **[YES]** to overwrite the present point.

Press **[NO]** to input a new name.

Press **[ADD]** to record the point as another record with the same name.

21.1 Recording Instrument Station Data

Instrument station data can be stored in the current JOB.

- The items that can be recorded are the instrument station coordinates, point number, instrument height, codes, operator, date, time, weather, wind, temperature, air pressure and atmospheric correction factor.
- If instrument station data is not stored for the current JOB, the previously stored instrument data settings will be used.

► PROCEDURE

1. Allocate the **[RECORD MENU]** softkey to the Meas Mode screen.
2. Press **[RECORD MENU]** to display <Record>.
 - Current JOB name is displayed.

21. RECORDING DATA - RECORD MENU -

3. Select "Stn Data".

- Select **[LIST]** to recall and use the registered coordinates.

 "12.1 Entering Instrument Station Data and Azimuth Angle PROCEDURE Reading in Registered Coordinate Data"

4. Press **[EDIT]** and set the following data items.

- (1) Instrument station coordinates
- (2) Point number
- (3) Instrument height
- (4) Code
- (5) Operator
- (6) Date
- (7) Time
- (8) Weather
- (9) Wind
- (10) Temperature
- (11) Air pressure
- (12) Atmospheric correction factor

- When inputting code, press **[ADD]** and **[LIST]** are displayed. Press to display saved codes in reverse chronological order. Align the cursor where you want to input the registered code.

 For reviewing and saving codes in JOB-DATA mode, see "23.3 Registering/Deleting Codes" and "23.4 Reviewing Codes"

- To set the atmospheric correction factor to 0ppm, press **[0ppm]**. The temperature and air pressure are set to the default setting.

N0:	187-03-1/4
E0:	-40741-09-1/4
Z0:	4-00-3/4
Pt.	Pt.004
Inst.	HT 3-07-0
	1 2 3 4

Cd	↑
:pole	
Operator	↓
:SOKKIA	
OK	ADD LIST EDIT

Date	: Jan/28/2006	↑
Time	: 00:00:00	
Weath	: Fine	↓
Wind	: Calm	
OK		

Temp.	: 59°F	↑
Press.	: 29.9 inchHg	
ppm	: 0	↓
OK	0ppm	EDIT

5. Check the input data, then press **[OK]** to return to <Record>



- Maximum point number size: 14 (alphanumeric)
- Input range of target height: -9999.999 to 9999.999 (m)
- Maximum code/operator size: 16 (alphanumeric)
- Weather selection: Fine, Cloudy, Light rain, Rain, Snow
- Wind selection: Calm, Gentle, Light, Strong, Very strong
- Temperature range: -30 to 60 (°C) (in 1°C step)/-22 to 140 (°F) (in 1°F step)
- Air pressure range: 500 to 1400 (hPa) (in 1 hPa step)/375 to 1050 (mmHg) (in 1mmHg step)/14.8 to 41.3 (inch Hg) (in 0.1 inch Hg step)
- Atmospheric correction factor range (ppm): -499 to 499

21.2 Recording Backsight Point

Backsight station data can be stored in the current JOB. Azimuth angle setting method can be selected from “inputting azimuth angle” or “calculating coordinates”.

►PROCEDURE Inputting azimuth angle

1. Allocate the **[RECORD MENU]** softkey to the Meas mode screen.
2. Press **[RECORD MENU]** to display <Record>.
3. Select “Backsight Data”.
4. Select “By Entering Angle”.
Angle measurement values are displayed in real time.

Record JOB1
Stn Data
Backsight Data
Angle Data
Dist Data
Coord Data

REC/Backsight
By Entering Angle
By Backsight Pt.

21. RECORDING DATA - RECORD MENU -

5. Input Azimuth angle.

REC/Backsight
Shoot Backsight
ZA 90° 12' 34"
HAR 130° 12' 34"
HAR: [REDACTED]
[EDIT] [RECORD]

6. Sight the backsight, press **[RECORD]** in the screen of step 5, and set the following items.

- (1) Code
- (2) Rod height
- (3) Point number

ZA 90° 12' 34"
HAR 0° 00' 00"
Cd [REDACTED]
Rod HT 0-00-0 ▾
[OK] [ADD] [LIST] [EDIT]

7. Check the input data, then press **[OK]** to set the backsight station. <Record> is restored.

Pt. [REDACTED] 1 ▲
[OK] [EDIT]

►PROCEDURE Calculating azimuth angle by coordinates

1. Press **[RECORD MENU]** to display <Record>.
2. Select "Backsight Data".
3. Select "By Backsight Pt."

REC/Backsight
By Entering Angle
By Backsight Pt.

4. Input the backsight station coordinates.
 - When you wish to read in and set coordinate data from memory, press **[LIST]**.

REC/Backsight
NBS : [REDACTED] 3-04-0
EBS : 3-04-0
ZBS : <Null>
[LIST] [EDIT] [OK]

 "12.1 Entering Instrument Station Data and Azimuth Angle PROCEDURE Reading in Registered Coordinate Data"

5. Press **[OK]** in the screen of step 4. Angle measurement values are displayed in real time. Calculated Azimuth angle is also displayed.

REC/Backsight
Shoot Backsight
ZA 90°12'34"
HAR 123°12'34"
Azmth 45°00'00"
RECORD

6. Sight the backsight, press **[RECORD]** in the screen of step 5, and set the following items.

- (1) Code
- (2) Rod height
- (3) Point number

ZA 90°12'34"
HAR 45°00'00"
Cd [REDACTED]
Rod HT 0-00-0
▼
OK ADD LIST EDIT

Pt. [REDACTED] 1
▲
OK EDIT

7. Check the input data, then press **[OK]** to set the backsight station. <Record> is restored.

21.3 Recording Angle Measurement Data

Angle measurement data can be stored in the current JOB.

- It is convenient to use **[AUTO]** to perform automatic operation from angle measurement to recording.

►PROCEDURE

1. Allocate the **[RECORD MENU]** softkey to the Meas mode screen.
2. Press **[RECORD MENU]** to display <Record>.
3. Select "Angle Data" and sight the point to be recorded. Angle measurement values are displayed in real time.

REC/Angle	rec 2922
ZA 60°15'40"	■
HAR 110°30'45"	
Pt. Pt.002	
AUTO	SET O ANG RECORD

21. RECORDING DATA - RECORD MENU -

4. Press **[RECORD]** in the screen of step 3, then press **[EDIT]**.
Set the following items.

- (1) Code
- (2) Rod height
- (3) Point number

ZA	60° 15' 40"		
HAR	110° 30' 45"		
Cd	[REDACTED]		
Rod HT	3-08-1/4 ▾		
OK	ADD	LIST	EDIT

Pt.	[REDACTED] ▲
OK	EDIT

5. Check the input data, then press **[OK]**.

6. To continue measurement, sight the next point, then perform steps 4 and 5 above.

- Press **[AUTO]** to perform angle measurement and automatically record the results. **[AUTO]** is convenient for recording measurement data when point number, code, and rod height are not set.

REC/Angle	rec 2923
ZA	80° 30' 15"
HAR	120° 10' 00"
Pt.	Pt .001
Recorded	

7. Press **{ESC}** to quit measurement and restore <Record>.

21.4 Recording Distance Measurement Data

Distance measurement data can be stored in the current JOB.



►PROCEDURE

1. Allocate the **[RECORD MENU]** softkey to the Meas mode screen.
2. Press **[DIST]** in the second page of Meas mode to perform distance measurement.
 "11.1 Distance and Angle Measurement"

3. Press **[RECORD MENU]** to display <Record>. Select "Dist Data" to display the measurement results.

REC/Dist	rec 2923
H	369-11-1/4
ZA	80°30'15" 
HAR	120°10'00"
Pt.	Pt.001
AUTO	DIST RECORD

4. Press **[RECORD]** in the screen of step 3, then press **[EDIT]**. Set the following items.
 - (1) Code
 - (2) Rod height
 - (3) Point number

S	375-01-0
ZA	80°30'15"
HAR	120°10'00"
Cd	
Rod HT	3-08-1/4 
OK	ADD LIST EDIT

5. Check the input data, then press **[OK]**.
6. To continue measurement, sight the next point, press **[DIST]**, then perform steps 4 and 5 above.
7. Press **{ESC}** to quit measurement and restore <Record>.

- When the same point number data is overwritten, the overwritten data is deleted.



- Once the data has been recorded, **[RECORD]** is not displayed in order to prevent double recording.

21.5 Recording Coordinate Data

Coordinate data can be stored in the current JOB

►PROCEDURE

1. Allocate the **[RECORD MENU]** softkey to the Meas mode screen.
2. Perform coordinates measurement in the Meas mode screen.
[ESC] "12. COORDINATE MEASUREMENT"

3. Press **[RECORD MENU]** to display <Record>. Select "Coord Data" to display the measurement results.

```
REC/Coord.    rec 2923
N      1136-02-3/4
E      415-05-1/4
Z      51-04-3/4
Pt.    Pt. 003
[AUTO] [TAKESHOT] [RECORD]
```

4. Press **[RECORD]**, then press **[EDIT]**. Set the following items.

- (1) Code
- (2) Rod height
- (3) Point number

```
N      1136-02-3/4
E      415-05-1/4
Z      51-04-3/4
Cd [REDACTED]
Rod HT 12-00-0
[OK] [ADD] [LIST] [EDIT]
```

5. Check the input data, then press **[OK]**.
6. To continue measurement, sight the next point, press **[TAKESHOT]**, then perform steps 4 and 5 above.
7. Press **{ESC}** to quit measurement and restore <Record>.

21.6 Recording Distance and Coordinate Data

Distance measurement data and coordinate data can be stored in the current JOB at the same time.

- Both distance measurement data and coordinate data are recorded as the same point number.
- Distance measurement data is recorded first, then coordinate data is recorded.

►PROCEDURE

1. Allocate the **[RECORD MENU]** softkey to the Meas mode screen.
2. Press **[RECORD MENU]** to display <Record>.
3. Select "Dist + Coord Data" to display <REC/DIST+C>.

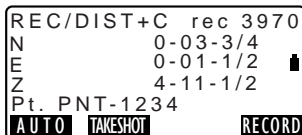

4. Sight the point and press **[TAKESHOT]** to begin the measurement.
The measurement results are displayed.
5. Press **[RECORD]** in the screen of step 3, then press **[EDIT]**.
Set the following items.
 - (1) Code
 - (2) Rod height
 - (3) Point number
6. Check the input data, then press **[OK]**.
7. Press **{ESC}** to quit measurement and restore <Record>.

21.7 Recording Notes

This procedure prepares notes data and records it in the current JOB.

►PROCEDURE

1. Allocate the **[RECORD MENU]** softkey to the Meas mode screen.
1. Press **[RECORD MENU]** to display <Record>. Select "Note".
2. Press **[EDIT]** and enter the note data.
3. After inputting the note data, press **[OK]** to return to <Record>.



- Maximum note length: 60 characters (alphanumeric)

21.8 Reviewing JOB Data

It is possible to display the data within the current JOB.

- It is possible to search for data within the JOB to be displayed by point number. But the note data cannot be searched.
- Known point data that are entered from an external instrument are not reviewed.

►PROCEDURE Reviewing JOB data

1. Allocate the **[RECORD MENU]** softkey to the Meas mode screen.
2. Press **[RECORD MENU]** to display <Record>. Select "View Data" to display the list of recorded points.

Stn	Pt. 1
Dist	1
Crđ.	2
Dist	3
Ang.	4
↑↓...P	TOP LAST SEARCH

3. Select the point number to be displayed in detail and press **[←|→]**. Details of the data is displayed. This screen contains distance measurement data.

S	369-08-3/4
ZA	20°31'21"
HAR	117°32'21"
Pt. 1	
Inst. HT	37-11-1/4
NEXT	PREV TO EDIT RED

- To display previous data item, press **[PREV]**.
- To display next data, press **[NEXT]**.
- Press **[TO EDIT]** to edit code/rod height/point number of the selected point number. Items that can be edited depends on the type of data selected. Press **[OK]** to confirm changes and return to the previous screen.
- **[↑↓...P]** = Use {▲}/{▼} to select individual point.
- **[↑↓...P]** = Use {▲}/{▼} to move from page to page.
- Press **[TOP]** to display first data.
- Press **[LAST]** to display last data.
- Press **[SEARCH]** to search for point number. Input the point number after "Pt. No."
- The search may take time if many data are registered.

Azmth	12°34'56"
H	378-11-1/4
V	-903-05-1/2
Pt. 3	
Rod HT	378-11-1/4
NEXT	PREV OBS

21. RECORDING DATA - RECORD MENU -

- Press **[RED]** to display the reduced data screen shown at right.
Press **[OBS]** to return to the previous screen.
4. Press **{ESC}** to conclude detailed display and restore the list of points.
Press **{ESC}** again to restore <Record>.



- If more than two points with the same point name exist in the current JOB, SCT finds the newer data only.

21.9 Deleting Recorded JOB Data

It is possible to delete data from the currently selected JOB.

►PROCEDURE Deleting Recorded JOB data

1. Press **[REC]** in the third page of Meas mode to display <REC>. Select "Deletion" to display the list of recorded points.

```
Dist + Coord data
Note
View
Deletion
```

2. Select the data item to be displayed in detail and press **[←]**. Details of the data are displayed.

```
Stn 1
RED 2
Bkb 2
Ang. 2
Dist 3
↑...P TOP LAST SEARCH
```

```
S 12-03-0
ZA 20°31'21"
HAR 117°32'21"
Cd 1010
Rod HT 12-03-0
NEXT PREV DELETE
```

- To display previous data item, press **[PREV]**.
- To display next data, press **[NEXT]**.
- **[↑↓...P]** = Use {▲}/▼ to move from page to page.
- **[↑↓...P]** = Use {▲}/▼ to select individual point.
- Press **[TOP]** to display first data.
- Press **[LAST]** to display last data.
- Press **[SEARCH]** to search for point number. Input the point number after "Pt. No".
The search may take time if many data are registered.

21. RECORDING DATA - RECORD MENU -

3. Press **[DELETE]** to display the screen at right.
Press **[YES]** to delete and return to the second screen in step 1.
- Press **[NO]** to return to the second screen in step 1 without deleting.

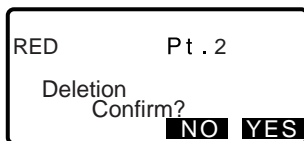

- Check data items before deleting to avoid losing important data.
- Deleting an important data item, such as instrument station coordinates, can prevent successful completion of software operations that require such data after outputting to an external device.

22. SELECTING/DELETING A JOB

22.1 Selecting a JOB

Select the current JOB.

- A total of 10 JOBS have been prepared, and JOB1 was selected when your SCT was shipped from the factory.
- The names of the JOBS have been preset as JOB1 to JOB10; you can change them to any names you wish.



Current JOB

Measurement results, instrument station data, known points data, notes and coordinate data are recorded in the current JOB.

 Registering known point data: “23.1 Registering/Deleting Known Point Data”

►PROCEDURE JOB selection and scale factor setting

1. Select “JOB” in JOB-DATA Mode.

```
Jobs/Data Menu
Job.JOB1
JOBS
Enter Data
Code List
```

2. Select “Select JOB”.
<Select JOB> is displayed.

```
JOBS
Select JOB
Delete JOB
Download JOBS
Comms Setup
```

3. Press [LIST].

- JOB can also be selected by pressing {▲}/{▼}.
- The numbers to the right represent the number of data items in each JOB.
- “*” means that the JOB has not been output to an external device yet.

```
Select JOB
: JOB1
```

```
LIST EDIT
```

22. SELECTING/DELETING A JOB

- Align the cursor with the desired JOB as the current JOB and press {←}.
The JOB is determined.

Select JOB	
JOB01	46
* ATUGI	254
JOB03	0
JOB04	0
JOB05	0



- The list of JOB names is contained on up to 2 pages.

►PROCEDURE Inputting a JOB name

- Select "JOBS" in JOB-DATA mode.
- Select "Select JOB" in <JOBS>. Select JOB by pressing {←/→}. Press [EDIT] and input the new JOB name and press {←}. <JOB> is restored.

JOBS
Select JOB
Delete JOB
Download JOBS
Comms Setup

Select JOB
: JOB1
LIST
EDIT

Select JOB
:
1
2
3
4



- Maximum size of JOB name: 12 (alphanumeric)

22.2 Deleting a JOB

It is possible to clear the data within a designated JOB. After the data has been cleared, the JOB name returns to the name allocated when the SCT was shipped.



- A JOB that has not been output to an auxiliary device (displayed with *) cannot be deleted.

► PROCEDURE

1. Select "JOBS" in JOB-DATA Mode.

2. Select "Delete JOB"
<Delete JOB> is displayed.

- The numbers to the right represent the number of data items in each JOB.

```

JOBS
Select JOB
Delete JOB
Download JOBS
Comms Setup
  
```

```

Delete JOB
JOB01           46
*ATUGI         254
JOB03           12
JOB04           0
JOB05           0
  
```

3. Align the cursor with the desired JOB and press {←}.
4. Press [YES]. The data within the JOB that is selected is deleted and <Delete JOB> is restored.

```

JOB03
Deletion
Confirm ?
      NO  YES
  
```

23. REGISTERING/DELETING DATA

23.1 Registering/Deleting Known Point Data

It is possible to register or delete coordinate data of the known points in the current JOB.

The coordinate data that has been registered can be output during setting for use as instrument station, backsight station, known point, and stakeout point coordinate data.

- It is possible to register 10000 items of coordinate data, including the data inside the JOBS.
- There are two registration methods: key entry and entry from an external instrument.
 - ☞ Communication cables: "29.2 Optional Accessories"
Output format and command operations: "Interfacing with the SOKKIA SDR Electronic Field Book" and "Command Explanations" manuals.
- When entering known point data from an external device, SCT does not check the repeated point number.
- Communication setup can be performed in the known data as well. Select "Comms Setup" in <Enter Data>.



- When "inch" is selected as the distance unit, the value must be input in "US feet" or "feet."

► PROCEDURE Using the key entry method to register known point coordinate data

1. Select "Enter Data" in JOB-DATA Mode.

- Current JOB name is displayed.

2. Select "Key in Pt Data" and input known point coordinates and point number.

				rec 3991
N	1874	03	1/4	
E	-662	-08	-1/4	
Z	1008	-11	-1/4	
Pt.	5			
	1	2	3	4

3. After setting the data, press

{←}.

The coordinate data is recorded in the current JOB and screen in step 2 is restored.

				rec 2641
N	1874	-03	-1/4	
E	-662	-08	-1/4	
Z	1008	-11	-1/4	
Pt.	5			
	Recorded			

- Continue to enter other known point coordinate data.
- After the registration of all the coordinate data has been completed, press **{ESC}** to restore <Enter Data>.

►PROCEDURE Entering known point coordinate data from an external instrument

- Connect SCT and host computer.
- Select "Enter Data" in JOB-DATA Mode.
 - Current JOB name is displayed.

- Select "Upload Pt Data" to display <Upload Pt Data>. Coordinate data starts to be entered from an external instrument and the number of received items is displayed on the screen. When data reception is completed, <Enter Data> is displayed.

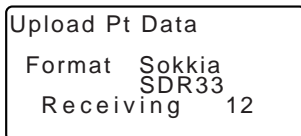

```

Upload Pt Data
Format   Sokkia
         SDR33
Receiving 12
  
```

- Press **{ESC}** to stop data reception in progress.

►PROCEDURE Deleting designated coordinate data

- Select "Enter Data" in JOB-DATA Mode.
- Select "Delete Pt. Data" to display the list of known point data.

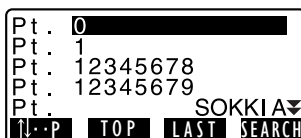

```

Pt. 0 ██████████
Pt. 1 ██████████
Pt. 12345678
Pt. 12345679
Pt. ██████████ SOKKIA
↑↓·P TOP LAST SEARCH
  
```

23. REGISTERING/DELETING DATA

3. Select the point number to be deleted and press {←}.

- [↑↓...P] = Use {▲}/ {▼} to select individual point.
- [↑↓...P] = Use {▲}/ {▼} to move from page to page.
- Press [TOP] to display top of point number list.
- Press [LAST] to display end of point number list.
- Press [SEARCH] to search for point number. Input the point number after "Pt. no."
The search may take time if many data are registered.

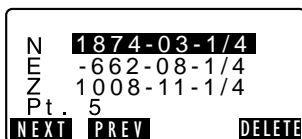

4. Press [DELETE] to delete the selected point number.

- Press [PREV] to display previous data.
- Press [NEXT] to display next data.

5. Press {ESC} to quit the point number list and return to <Enter Data>.

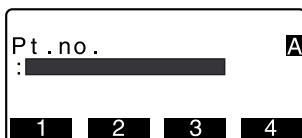

►PROCEDURE Clearing all coordinate data at once (initialization)

1. Select "Enter Data" in JOB-DATA Mode.

2. Select "Clear Pt. Data" and press {←}.

3. Press [YES].
<Enter Data> is restored.

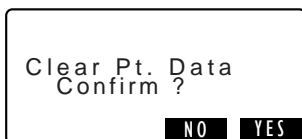

23.2 Reviewing Known Point Data

It is possible to display all the coordinate data within the current JOB.

►PROCEDURE

1. Select "Enter Data" in JOB-DATA Mode.
 - Current JOB name is displayed.
2. Select "View Pt. Data"

The point number list is displayed.

```

Pt. 0
Pt. 1
Pt. 12345678
Pt. 12345679
Pt. SOKKIA
↑N·P TOP LAST SEARCH
  
```

3. Select the point number to be displayed and press {←}.

The coordinates of the selected point number are displayed.

```

N 1874-03-1/4
E -662-08-1/4
Z 1008-11-1/4
Pt. 5
NEXT PREV
  
```

4. Press {ESC} to restore the point number list.

Press {ESC} again to restore <Enter Data>.

23.3 Registering/Deleting Codes

It is possible to save codes in memory. You can also read in codes registered in memory when recording instrument station data or observation data.

►PROCEDURE Inputting Codes

1. Select "Code List" in JOB-DATA Mode.

23. REGISTERING/DELETING DATA

2. Select "Key in Code"
Enter the code and press {←}.
The code is registered and <Code
List> is restored.

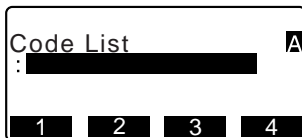

- Maximum code size: 16 (alphanumeric)
- Maximum number of codes registered: 40

►PROCEDURE Deleting codes

1. Select "Code List" in JOB-DATA
Mode.
2. Select "Delete Code." The
registered code list is displayed.
3. Align the cursor with the code to
be deleted and press [DELETE].
The designated code is deleted.
4. Press {ESC} to restore <Code
List>.

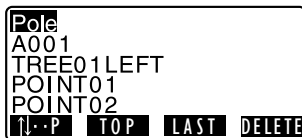

- If you select "Clear Code List" in step 2 and then press [YES], all registered codes are deleted.

23.4 Reviewing Codes

►PROCEDURE

1. Select "Code List" in JOB-DATA
Mode.

2. Select "View Code List."
The registered code list is displayed.

```
Pole  
A001  
Point 001  
TREE01 LEFT  
POINT01  
↓·P TOP LAST
```

3. Press **{ESC}** to restore <Code List>.

24. OUTPUTTING JOB DATA

It is possible to output data within a JOB to a host computer or printer.

 Communication cables: "29.2 Optional Accessories"

Output format and command operations: "Interfacing with the SOKKIA SDR Electronic Field Book" and "Command Explanations" manuals.

- Measurement results, instrument station data, known point data, notes, and coordinate data in the JOB is output.
- Known point data entered from an external instrument is not output.
- Communication setup can be performed in the JOBS menu as well. Select "Comms Setup" in <JOBS>.



- When "inch" is selected as the distance unit, data is output in "US feet" or "feet" depending on the feet unit selected.

► PROCEDURE Outputting JOB data to host computer

1. Connect SCT and host computer.
2. Select "JOBS" in JOB-DATA Mode.
3. Select "Download JOBS" to display the JOB list.
4. Select the JOB to be output and press .
"Out" appears to the right of the JOB selected. You can select as many JOBS as you want.

* JOB01	Out
ATUG1	254
JOB03	Out
JOB04	0
JOB05	0
	

- "*" means the JOB has not been output to an external device yet.

5. Press **[OK]**.

6. Select the output format and press **{←}**.

Output starts. When the output is complete, the JOB list is restored. It is possible to continue output of the next JOB.

- To stop output, press **{ESC}**.

```
Download JOBS
Sokkia SDR33
Sokkia SDR2x
Printed Format
```

```
Upload Pt Data
Format Sokkia
SDR33
Receiving 12
```

►PROCEDURE Outputting JOB data to printer

1. Select "JOBS" in JOB-DATA Mode.
2. Select "Download JOBS" to display the JOB list.
3. Select the JOB to be output and press **{←}**.
"Out" appears to the right of the JOB selected. You can select as many JOBS as you want.
4. Press **[OK]**.
5. Connect SCT and printer.
6. Turn ON the printer.
7. Select "Printed Format" and press **{←}**. Output starts. When the output is complete, the JOB list is restored. It is possible to continue output of the next JOB.

25. CHANGING THE SETTINGS

This section explains the contents of parameter settings, how to change settings and how to perform initialization.

25.1 Changing Instrument Options

The following explains the EDM settings and setting modes in Meas mode. Each item can be changed to meet your measurement requirements.

- “*”: Factory setting

● EDM settings (items set, options, and input range)

Press **[EDM SETTINGS]** when allocated to Meas mode.

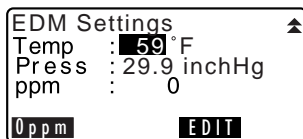
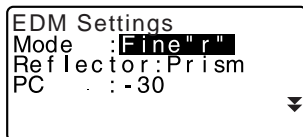

- **[EDIT]**: Sets items
- **[0ppm]**: Atmospheric correction factor returns to 0 and temperature and air pressure are set to the default values.
- Atmospheric correction factor is calculated and set using the entered values of the temperature and air pressure. Atmospheric correction factor can also be entered directly.

Mode (Distance measurement Mode): Fine "r"*, Fine AVG (Setting: 1 to 9 times), Fine "s", Rapid "r", Rapid "s", Tracking

Reflector: Prism*/Sheet

PC (Prism constant): -99 to 99 mm ("Prism" is selected: -30*, "Sheet" is selected: 0*)

Temp. (Temperature): -30 to 60°C (15*), -22 to 140°F (59*)

Air pressure: 500 to 1400hPa (1013*), 375 to 1050mmHg (760*), 14.8 to 41.3 inchHg (29.9*)

ppm (Atmospheric correction factor): -499 to 499 (0*)



Atmospheric correction factor

The SCT measures the distance with a beam of light, but the velocity of this light varies according to the index of refraction of light in the atmosphere. This index of refraction varies according to the temperature and air pressure.

- To precisely determine the atmospheric correction factor, the average temperature and air pressure along the measurement beam route must be taken. Take care when calculating the correction factor in mountainous terrain as the difference in height will result in differences in atmospheric conditions between two points.
- The SCT is designed so that the correction factor is 0 ppm at an air pressure of 29.9 inchHg and a temperature of 59°F.
- By inputting the temperature and air pressure values, the atmospheric correction value is calculated and set into the memory. Calculate the atmospheric correction factor as shown in the following formula.

$$\text{ppm} = 278.96 - \frac{0.2904 \times \text{air pressure (hPa)}}{1 + 0.003661 \times \text{air temperature (°C)}}$$

- If the weather correction is not required, set the ppm value to 0.



Prism constant correction

Reflective prisms each have their prism constant. Set the prism constant correction value of the reflective prism you are using.

- The following are samples of the prism constant correction values of reflective prisms from Sokkia.

AP01S+AP01AR
(Constant = 30mm)

AP01AR (Constant = 40mm)

CP01 (Constant = 0mm)

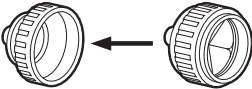

Correction Value = -30



Correction Value = -40



Correction Value = 0

25. CHANGING THE SETTINGS

● Settings in SETTINGS mode (items set, options, and input range)

Select "Shot Settings" in SETTINGS mode

```
Dist mode: Hdist
Level crn : Yes(H,V)
coll.crn  : Yes
C&R crn.  : No
V manual  : No
V. obs    : Zenith ▼
```

```
Coord.     : N-E-Z ▲
Ang. reso. : 1"
Sea level crn : No
Stn.ID Incr. : 100
Dist.reso.  : 1/8 inch
```

Dist mode: Sdist, Hdist*, Vdist

Tilt crn (Tilt angle compensation): Yes(H,V)*, Yes(V), No

coll. crn (Collimation correction): Yes*, No

C&R crn. (Earth curvature and refraction correction): No*, K=0.142, K=0.20

V manual: Yes, No*

V.obs (Vertical angle display method): Zenith*, Horiz, Horiz 90° (Horizontal ±90°)

Coord.: N-E-Z*, E-N-Z

Ang. reso. (Angle resolution): 1"*, 5"

Sea level crn. (Sea level correction): Yes, No*

Stn. ID Incr. (station ID increment): 0 to 99999 (100*)

Dist.reso. (Distance resolution): 1/8*, 1/16



Sea level correction

The SCT calculates horizontal distance using slope distance values. As this horizontal distance does not take height above sea level into consideration, performing spherical correction is recommended when measuring at high altitudes. Spherical distance is calculated as follows.



Automatic tilt angle compensation mechanism

The vertical and horizontal angles are automatically compensated for small tilt errors using the 2-axis tilt sensor.

- Read the automatically compensated angles when the display has stabilized.
- The horizontal angle error (vertical axis error) fluctuates according to the vertical axis, so when the instrument is not completely leveled, changing the vertical angle by rotating the telescope will cause the displayed horizontal angle value to change.

Compensated horizontal angle = Measured horizontal angle + Tilt in angle / tan (Vertical angle)

- When the telescope is directed close to the zenith or nadir angle, tilt compensation is not applied to the horizontal angle.



Collimation correction

The SCT has a collimation correction function that automatically corrects horizontal angle errors caused by horizontal axis and leveling axis errors.



V mode (vertical angle display method)

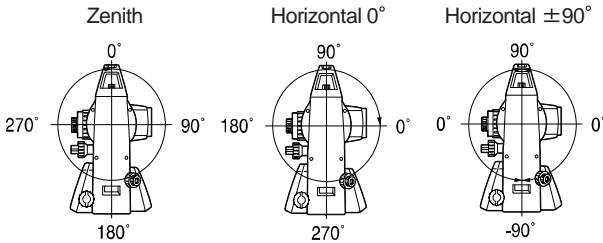

Select "Instr. Settings" in SETTINGS mode

Power off	: 30min
Reticle lev	: 3
Contrast	: 10
Resume	: Off
EDM standby	: Off
EDM ALC	: Hold

Power off: 5min, 10min, 15min, 30min*, No

Reticle lev: 0 to 5 level (3*)

Contrast: 0 to 15 level (10*)

Resume: On, Off*

EDM standby: On, Off*

EDM ALC: Hold*, Free



Power-saving automatic cut-off

To save power, power to the SCT is automatically cut off if it is not operated for the selected time.



Resume function

When the Resume function is set to "On," and the power is switched off and then on again, the screen appearing before the instrument was switched off

25. CHANGING THE SETTINGS

is redisplayed. Also, all parameter settings are saved. Memory backup period is about one week, after which the Resume function is cancelled.



EDM Standby

Set the power supply status of the EDM. When the EDM standby function is set to "ON", the EDM power status is set to standby. When **[DIST]** is pressed, you can reduce the time until the results are displayed.



EDM ALC

Set the light receiving status of the EDM. While carrying out continuous measurement, set this item according to the measurement conditions.

- When EDM ALC is set to "Free," the instrument's ALC will be automatically adjusted if an error occurs as a result of the amount of light received. Set to "Free" when the target is moved during measurement or different targets are used.
- When "Hold" is set, the amount of light received will not be adjusted until continuous measurement is completed.
- If an obstacle intermittently obstructs the light beam during continuous measurement and the "Signal off" error occurs, each time the obstruction occurs it takes some time for the amount of light received to be adjusted and the measurement value displayed. Set to "Hold" when the light beam used for measurement is stable but is frequently obstructed by obstacles such as people, cars, or tree branches etc.



- The EDM ALC setting will automatically be switched to "Free" when the distance measurement mode is set to "Tracking" (target is moved during distance measurement).

Select "Comm Settings" in SETTINGS mode

```
Bluetooth : Off
Baud rate: 1200bps
Data bits: 8bit
Parity    : Not set
Stop bit  : 1bit
Check sum: No
```

```
Xon/Xoff : Yes
```

Bluetooth: On, Off*

Baud rate: 1200bps*, 2400bps, 4800bps, 9600bps, 19200bps, 38400bps

Data bits: 8bit*, 7bit

Parity: Not set*, Odd, Even

Stop bit: 1bit*, 2bit

Check sum: Yes, No*

Xon/Xoff: Yes*, No

 Output format and command operations: "Interfacing with the SOKKIA SDR Electronic Field Book" and "Command Operations" manuals.

Select "Unit Settings" in SETTINGS mode

Temp.	: ° F
Press.	: inchHg
Angle	: degree
Dist	: inch
Feet	: US feet

Temp. (Temperature): °C, °F*

Press.: hPa, mmHg, inchHg*

Angle: degree*, gon, mil

Dist: meter, feet, US feet, inch*

Feet (only displayed when "feet" or "inch" selected above.:

Int. feet (1m = 3.280839895), US feet* (1m = 3.280833333)



Inch (Fraction of an inch)

"Fraction of an inch" is the unit used in the United States and expressed like the following example.

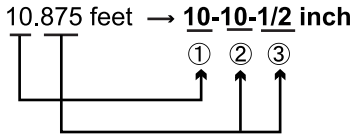

① 10.000 feet

② 0.875 feet x 12=10.5 inch

③ 0.5 inch=1/2 inch



- Even if "inch" is selected in this setting, all the data including the result of area calculation are output in "feet" and all the distance values must be input in "feet". In addition, when the "inch" display exceeds the range, it is displayed in "feet".



International feet and US survey feet

The SCT can display feet values in International feet and US survey feet units.

International feet, the standard feet units, are referred to simply as "feet" elsewhere in this manual.

25. CHANGING THE SETTINGS

US survey feet are units used in surveys by the U.S. Coast and Geodetic Survey and are referred to as "US feet" in this manual.

When "feet" or "inch" is selected in "Dist", the "Feet" item will appear on the screen as below. When "meter" is selected, this item will not be displayed.

25.2 Allocating Key Functions

It is possible to allocate the softkeys in Meas mode to suit the measurement conditions. It is possible to operate the SCT efficiently because unique softkey allocations can be preset to suit various applications and the ways that different operators handle the instrument.

- The current softkey allocations are retained until they are revised again, even when the power is cut off.
- It is possible to register two sets of key function allocations: user setting 1 and user setting 2.
- It is possible to recall the softkey arrays registered for User 1 and User 2 as necessary.



- When softkey allocations are recorded and registered, the previously recorded key settings are cleared. When a softkey array is recalled, the key array is changed to the key array that has been recalled, clearing the previous key array. Be sure to remember this.

• The following are the softkey allocations when the SCT was shipped.

Page 1 [LEVEL] [SET 0 ANG] [STAKEOUT] [ANG LEFT RIGHT]

Page 2 [HOLD ANG] [DIST] [COORD] [MENU]

• The following functions can be allocated to the softkeys.

[DIST]	: Distance measurement
[▲ SHV DISPLAY]	: Switch between angle display and distance display
[SET 0 ANG]	: Set horizontal angle to 0
[COORD]	: Coordinates measurement
[MISSING LINE]	: Missing line measurement
[STAKEOUT]	: Stakeout measurement
[RECORD MENU]	: To Record menu
[EDM SETTINGS]	: Setting EDM
[H.ANG]	: Set required horizontal angle

[LEVEL]	: Display level angle
[MENU]	: To Menu mode (Resection measurement, Stakeout line, point projection)
[REMOTE ELEV]	: Remote elevation measurement
[RESEC]	: Resection measurement
[ANG RIGHT LEFT]	: Select horizontal angle right/left
[ZA / %]	: Switch between zenith angle/slope in %
[HOLD ANG]	: Hold horizontal angle/release horizontal angle
[RECALL ANGLE]	: Display final measurement data
[STREAM DATAOUT]	: Output measurement results to an external instrument
[SIGNAL DETECT]	: Return signal
[AREA CALC]	: Surface area measurement
[FEET AND METERS]	: Switch between feet/meters
[INSTR/ROD HT]	: Set the instrument station height and rod height
[STAKEOUT LINE]	: Stakeout line measurement
[S-O ARC]	: Setting-out arc measurement
[PT.PROJ]	: Point projection measurement
[INTSCT]	: Intersections measurement
[BLANK]	: No functions set

● Softkey Allocation Examples

It is possible to allocate the same key to each page (example 1). The same function can be allocated to more than one key on the same page (example 2). And it is also possible to allocate a function to only one key (example 3).

Allocation example 1:

P1 [DIST] [▲ SHV DISPLAY] [H.ANG] [EDM SETTINGS]

P2 [DIST] [▲ SHV DISPLAY] [H.ANG] [EDM SETTINGS]

Allocation example 2:

P1 [DIST] [DIST] [▲ SHV DISPLAY] [▲ SHV DISPLAY]

Allocation example 3:

P1 [DIST] [BLANK] [BLANK] [BLANK]

25. CHANGING THE SETTINGS

►PROCEDURE Allocating functions

1. Select "Define Key Setup" in SETTINGS Mode.
Select "Define Keys" Currently allocated softkeys are displayed in <Define Key Setup>.
2. Align the cursor with the softkeys whose allocation you want to change using $\{\blacktriangleright\}/\{\blacktriangleleft\}$.
The cursor of the selected softkey flashes.
3. Change the softkey function using $\{\blacktriangle\}/\{\blacktriangledown\}$.
Set the softkey function and its location by pressing $\{\blacktriangleright\}/\{\blacktriangleleft\}$. The set softkey stops flashing and the cursor flashes on the next softkey.
4. Repeat steps 2 to 3 only as many times as necessary.
5. Press [OK] to record the allocations and restore <Define Key Setup>.
The functions with their new allocations are displayed in Meas mode.

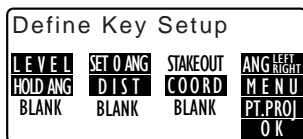

►PROCEDURE Registering an allocation

1. Allocate functions to the softkeys.
 $\{\text{F}\}$ "PROCEDURE Allocating functions"
2. Select "Define Key Setup" in SETTINGS mode.

3. Select "Save Defined"
Select either "User 1" or "User 2"
as the softkey array to be
registered.
4. Press {←}. The softkey array is
registered as user 1 or user 2 and
<Define Key Setup> is restored.

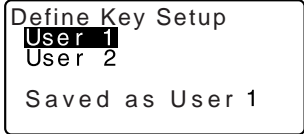

► **PROCEDURE Recalling an allocation**

1. Select "Define Key Setup" in
SETTINGS Mode.
2. Select "Recall Defined" Select the
key array for either User 1, User 2,
or Default (setting when the SCT
was shipped), and press {←}.
<Define Key Setup> is restored.
This displays the functions in the
recalled array in Meas mode.

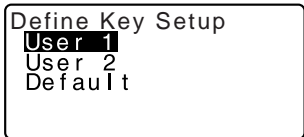

25.3 Changing Password

Set password can be changed.

- No password was set when the SCT was shipped.

► **PROCEDURE Changing password**

1. Select "Change Password" in
SETTINGS mode.
2. Input old password and press
{←}.

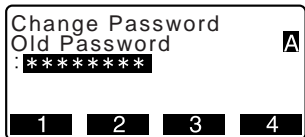

25. CHANGING THE SETTINGS

3. Input new password twice and press {←}. The password is changed and <Config> is restored.

Change Password			
New Password			
:*****			
New Password Again			
:*****			
1	2	3	4

- If no password was input as new password and {←} was pressed, no password is set.



- Input range of password: 3 or more characters and 8 or fewer characters

25.4 Restoring Default Settings

The following explains the two methods of restoring default settings:
Restoring set items to initial settings and turning power on. Initializing the data and turning power on.

- Restore the following items to the initial settings when the SCT was shipped.
EDM setting, SETTINGS mode settings (including softkey arrays)
 About initial settings when the SCT was shipped, “25.1 Changing Instrument Options”, “25.2 Allocating Key Functions”.
- Initialize the data. The following data is initialized.
Data within all jobs
Known point data within memory
Code data within memory

►PROCEDURE Restoring set items to initial settings and turning power on

1. Turn the power off.
2. While pressing **{F4}** and **{BS}**, press **{ON}**.
3. The SCT is turned on, "Default set" appears on the screen and all items are restored to their initial settings.

►PROCEDURE Initializing the data and turning the power on

1. Turn the power off.
2. While pressing **{F1}**, **{F3}** and **{BS}**, press **{ON}**.
3. The SCT is turned on and "Clearing Memory..." appears on the screen.

26. WIRELESS COMMUNICATION USING *BLUETOOTH* TECHNOLOGY

Bluetooth wireless technology allows the SCT to communicate wirelessly with other *Bluetooth* devices.



- Wireless communication using *Bluetooth* technology is an optional function. For availability of this option in your country, and for further information regarding this technology, contact your Sokkia agent.
- Use of this technology must be authorized according to telecommunications regulations of the country where the instrument is being used. Contact your Sokkia agent in advance.
- A radio station license is not required.
- Sokkia is not liable for the content of any transmission nor any content related thereto. When communicating important data, run tests beforehand to ascertain that communication is operating normally.
- Do not divulge the content of any transmission to any third party.
- Before starting transmission, check that operation will not take place within the vicinity of portable premises radio equipment or specified low-power radio equipment.
- In the case that the instrument causes radio interference with portable premises radio equipment, terminate the connection immediately and take measures to prevent further interference (e.g. connect using an interface cable). In the case that the instrument causes radio interference with portable specified low-power radio equipment, contact your Sokkia agent.
- When using other compatible *Bluetooth* devices, perform communication within a line-of-sight distance of approximately 2m. This distance becomes shorter when obstacles block the line of sight. Wood, glass and plastic will not impede communication. However, wood, glass and plastic containing metal frames, plates, foil and other heat shielding elements as well as coatings containing metallic powders may adversely affect *Bluetooth* communication and concrete, reinforced concrete, and metal will render it impossible. Use a vinyl or plastic cover to protect the instrument from rain and moisture.
- Perform communication at a distance of 3m or more from microwave ovens, which can cause significant interference. The SCT should also not be used within proximity to televisions and radios. Even though there may be no adverse effects with regard to *Bluetooth* communication, moving a *Bluetooth* compatible SCT closer to said equipment may result in electronic noise in sound or images, adversely affecting the signal reception of televisions and radios.
- Change location when proximity to a wireless device or broadcast station results in communication failure.
- When using the SCT near IEEE802.11b or IEEE802.11g standard wireless LAN devices or other devices that operate on the 2.4GHz ISM band, interference

may result, causing transmission speed to slow or even disrupting the connection completely. Turn off all devices not being used.

- The radio waves used by the SCT may be absorbed or scattered by rain, fog, and moisture from the human body with the limit of usable range becoming lower as a result. Similarly, usable range may also shorten when performing communication in wooded areas. Moreover, as wireless devices lose signal strength when close to the ground, perform communication at as high a position as possible.
- Sokkia cannot guarantee that the SCT will operate properly with all *Bluetooth* devices on the market.



Frequency bands

Bluetooth communication with the SCT uses the 2.4 GHz frequency band. This is the same band used by industrial, scientific, and medical (ISM) equipment such as microwaves, portable premises radio equipment (license required) and portable specified low-power radio equipment (license-exempt) used in factory production lines, and IEEE802.11b/IEEE802.11g standard wireless LAN devices.

Using the SCT within proximity to the above devices may result in interference causing communication failure or reduction of transmission speed.

Televisions and radios use a different frequency band.

Even if the SCT is used within proximity to the above equipment with no adverse effects with regard to transmission, moving a *Bluetooth* compatible device (including the SCT) closer to said equipment may result in electronic noise in sound or images.

26.1

Necessary settings for *Bluetooth* communication

Bluetooth wireless communication settings are performed in “Comm Settings” in SETTINGS mode.

► PROCEDURE Basic Settings

1. Select “Comm Settings” in SETTINGS mode.

26. WIRELESS COMMUNICATION USING BLUETOOTH TECHNOLOGY

2. Set "Bluetooth" to "On".



Bluetooth : On
Bluetooth setup
Link device list
My device info

3. Select "Bluetooth Setup".



Bluetooth : On
Bluetooth setup
Link device list
My device info

4. Set "Mode" to either "Master" or "Slave".

 Bluetooth connections"

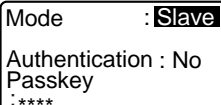

Mode : Slave
Authentication : No
Passkey
:****

5. Set "Link".

Select a companion device from among the *Bluetooth* devices registered in the SCT using {◀/▶}.

 Registering devices:
"PROCEDURE Registering Bluetooth companion devices"



Mode : Master
Link : DEVICE1
Authentication : No
Passkey
:****

- "Link" setting is not necessary when "Mode" is set to "Slave".

6. Set "Authentication". Select "Yes" or "No".

7. Set "Passkey". Set the same passkey as that for your *Bluetooth* device.

- Up to 16 numeral characters can be input. "0123" is the factory setting. Input characters will be displayed as asterisks (e.g. "*****").

8. Set check sum settings.

Note

- Even when "Authentication" is set to "No", a passkey is requested when authentication is set on the *Bluetooth* device being used.
- When "*Bluetooth*" is set to "On", "Xon/Xoff" will not be displayed. It is recommended that other communication settings are set to correspond with those of the *Bluetooth* device.



Bluetooth connections

- Communication between a pair of *Bluetooth* devices requires one device to be set as the "Master" and the other as the "Slave". To initiate connections from the SCT side, set the SCT as the "Master" device. To initiate connections from the paired device side, set the SCT as the "Slave" device.

►PROCEDURE Registering *Bluetooth* companion devices

1. Select "Comm Settings" in SETTINGS mode.
2. Set "*Bluetooth*" to "On".
3. Select "Link device list".
4. Register your *Bluetooth* device(s). Select a device and press [EDIT] to update related information.

- Select a device and press {←} to show details. Press [PREV]/[NEXT] to display details of the previous/next device.
- Press [DEL] to delete information for the selected device.

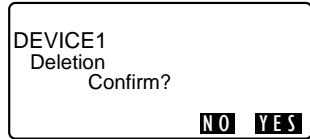
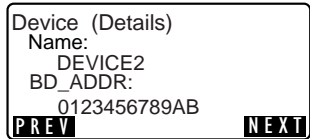
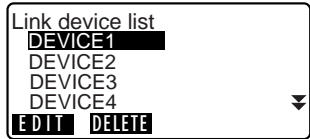

26. WIRELESS COMMUNICATION USING BLUETOOTH TECHNOLOGY

5. Input "Name" (device name) and "BD ADDR" (address) and press **[REG]**.

- 12 hexadecimal digits can be input.
- By pressing **[INQ]**, it is also possible to inquire about devices in the immediate vicinity and register their address.
Select an address from the list of devices discovered and press **[OK]**. The address is displayed "BD ADDR". (If SCT cannot find any devices within 30 sec., the inquiry will be canceled.)

```
Device registration
Name:
  DEVICE1
BD_ADDR:
  0123456789AB
[INQ] [EDIT] [REG]
```

```
Inquiry...
  0123456789AB
  123456789ABC
  23456789ABCD
  3456789ABCDE
[STOP] [OK]
```

►PROCEDURE Displaying *Bluetooth* module information for the SCT

1. Select "Comm Settings" in SETTINGS mode.
2. Set "*Bluetooth*" to "On" .
3. Select "My device info".
The *Bluetooth* information for the SCT is displayed. The "BD ADDR" for the SCT must be registered on your *Bluetooth* device.

```
Bluetooth : On
Bluetooth setup
Link device list
My device info
```

```
Bluetooth ID: B02706
Firmware: VerX.X.X

BD_ADDR:
  ABCDEF012345
```



Bluetooth Device Address



This is a number unique to one particular *Bluetooth* device used to identify devices during communication. This number consists of 12 characters (numbers 0 to 9 and letters from A to F). Some devices may be referred to by their *Bluetooth* device address.

26.2 Establishing a connection between the SCT and paired *Bluetooth* device

When "*Bluetooth*" is set to "On" in "Comm Settings" in SETTINGS mode

[] is displayed.

► PROCEDURE

- Complete the necessary settings for Bluetooth communication.
 -  "26.1 Necessary settings for Bluetooth communication"
 - To initiate communication from the side of the paired device set SCT to "Slave" and the device to "Master" (and vice versa).
- Press [] when allocated to the Meas mode screen. The *Bluetooth* module in the SCT powers on and connection starts.

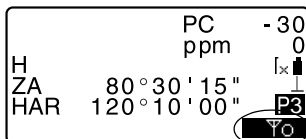

The *Bluetooth* icon indicates communication status.

 "5.2 Display Functions"

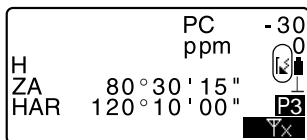

Note

- When "Mode" in "*Bluetooth Setup*" is set to "Slave", the establishing of a connection can only be initiated from the "Master" *Bluetooth* device.
- When "Mode" in "*Bluetooth Setup*" is set to "Master", SCT will attempt to establish a connection with the designated *Bluetooth* device (specified in "Link" in "*Bluetooth setup*").
- Softkeys (in Meas mode and <Detecting Signal>)
 - []: Press to enter waiting status ("Mode" is set to "Slave")/establish a connection ("Mode" is set to "Master")

26. WIRELESS COMMUNICATION USING BLUETOOTH TECHNOLOGY

[]: Press to cancel the connection/exit waiting status ("Mode" is set to "Slave")/stop establishing or cancel a connection ("Mode" is set to "Master")

- Audio tones

(While connecting/disconnecting)

Start paging/waiting:	short beep
Connection successfully established:	long beep
Connection canceled/being canceled:	two short beeps
Paging failed/waiting time out:	two short beeps



(While inquiring about other *Bluetooth* devices)

New device discovered:	short beep
Inquiry complete:	long beep

26.3 Measurement using *Bluetooth* communication

Data collectors can also be set as companion devices for wireless communication.

► PROCEDURE Performing measurement using a data collector

1. Complete the necessary settings for *Bluetooth* communication.
 "26.1 Necessary settings for Bluetooth communication"
2. Verify the current connection status by checking the *Bluetooth* icon in the Meas mode screen.
 "26.2 Establishing a connection between the SCT and paired Bluetooth device"
3. Initiate measurement using your *Bluetooth* device (e.g. a data collector). SCT will respond and measurement will start. Measured values are then displayed in the Meas mode screen.

26.4 Registering/Outputting data using *Bluetooth* communication

It is possible to set a computer as the partner device and output JOB data via wireless communication.

► **PROCEDURE** Entering known point coordinate data from an external instrument

1. Complete the necessary settings for *Bluetooth* communication.
☞ "26.1 Necessary settings for Bluetooth communication"
2. Verify the current connection status by checking the *Bluetooth* icon in the Meas mode screen.
☞ "26.2 Establishing a connection between the SCT and paired Bluetooth device"
3. Register known point data in JOB-DATA mode.
☞ "23.1 Registering/Deleting Known Point Data
PROCEDURE Entering known point coordinate data from an external instrument"
Coordinate data starts being entered from the external instrument.
 - If a connection has not yet been established, the screen at right is displayed. (Screens differ depending on the "Mode" setting. The displayed screen appears when "Mode" is set to "Slave".)
After a connection has been established, the data is entered.

Upload Pt Data
Waiting for
connection...

►PROCEDURE Outputting JOB data to a host computer

1. Complete the necessary settings for *Bluetooth* communication.

 "26.1 Necessary settings for Bluetooth communication"

2. Verify the current connection status by checking the *Bluetooth* icon in the Meas mode screen.

 "26.2 Establishing a connection between the SCT and paired Bluetooth device"

3. Output JOB data in JOB-DATA mode.

 "24. OUTPUTTING JOB DATA PROCEDURE
Outputting JOB data to host computer"

SCT starts outputting data.

- If a connection has not yet been established, the screen at right is displayed. (Screens differ depending on the "Mode" setting. The displayed screen appears when "Mode" is set to "Slave".)

After a connection has been established, the data is output.

Download JOBS

Format	Sokkia
Sending	SDR33
	12

Download JOBS

Waiting for connection...

27. WARNING AND ERROR MESSAGES

The following is a list of the error messages displayed by the SCT and the meaning of each message. If the same error message is repeated or if any message not shown below appears, the instrument has malfunctioned. Contact your Sokkia agent.

Check Target!

The air is shimmering a lot, etc., measuring conditions are poor.

The center of the target cannot be sighted.
Resight the target.

Calculation Error

Coordinates identical to the known point coordinates observed during resection exist. Set another known point so that the known point coordinates do not coincide.

Checksum error

A sending/repetition error has occurred between the SCT and external equipment.
Send/receive the data again.

Communication error

A reception error has occurred in coordinate data from an external instrument.
Check the settings of parameters concerning communication conditions.
 "25.1 Changing Instrument Options ● Settings in SETTINGS mode"

Flash Write Error!

Flash mount error!

It is impossible to read in data.
Contact your Sokkia agent.

Incorrect Password

Input password does not match set password. Input correct password.

Invalid Baseline

During stakeout line measurement or point projection measurement, baseline has not been defined correctly.

Memory is Full

There is no more room to enter data.
Record the data again after deleting unnecessary data from the JOB or coordinate data from the memory.

27. WARNING AND ERROR MESSAGES

Need 1st Shot

During missing line measurement, the observation of the starting position was not completed normally.

Sight the starting position accurately and press **[TAKESHOT]** to perform the measurement again.

Need 2nd Shot

During missing line measurement, the observation of the target was not completed normally.

Sight the target accurately and press **[MISSING LINE]** to perform the measurement again.

Need Offset Pt.

Observation of the offset point during offset measurement was not completed normally.

Sight the offset point accurately and press **[TAKESHOT]** to perform the measurement again.

Need Shot Data

During REM measurement, the observation of the target was not completed normally.

Sight the target accurately and press **[TAKESHOT]** to perform measurement again.

New Password Error

During new-password setting, the passwords input twice are different. Input new password twice correctly.

No Data

When searching for or reading in coordinate data or searching for code data, the search stopped either because the item in question does not exist or the data volume is large.

No Solution

The calculation of the instrument station coordinates during resection does not converge.

Assess the results and if necessary, perform the observation again.

Check Level!

The tilt of the instrument exceeds the tilt angle compensation range during measurement.

Sight again within $\pm 3'$.

Out of Value

During gradient % display, the display range (less than $\pm 1000\%$) has been exceeded.

During REM measurement, either the vertical angle has exceeded horizontal $\pm 89^\circ$ or the measured distance is greater than 9999.999m.

Install the instrument station far from the target.

The instrument station coordinates calculated during resection are too high. Perform the observation again.

During stakeout line measurement, scale factor has been less than 0.100000 or exceeded 9.999999.

Print or send first

JOB data output (transmission to the host computer or output to the printer) is not completed before JOB is cleared.

Either transmit the JOB to be cleared to the host computer or output it to the printer.

RAM cleared

(Displayed when the SCT is switched on) The resume function does not work because more than one week (memory back-up period) has passed since the SCT was last switched off.

After more than one week, even though "Resume" is still set to "On," the resume function has been canceled.

Coords are the Same

The same values are input in Pt.1 and Pt.2 in stakeout line measurement. SCT cannot define the baseline.

Target Moved?

Measuring conditions are poor, and there is not any reflective light for measuring distances.

Resight the target. When using reflective prisms, effectiveness will be improved by increasing the number of prisms used.

Time Out

Measuring conditions are poor, and due to the insufficient amount of reflective light, measuring could not be carried out within the time specified.

Resight the target. When using reflective prisms, effectiveness will be improved by increasing the number of prisms used.

Too Short

Input password has fewer than 3 characters. Password must have 3 or more characters and 8 or fewer characters.

27. WARNING AND ERROR MESSAGES

The calculated result is too large to be displayed on the screen in its totality.

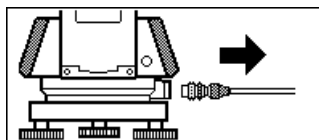

If the printer cable is attached during measurement, measurement cannot be carried out correctly. SCT notifies you by displaying the screen above and beeping. When the cable is removed, the previous screen is restored. If connected SDR or host computer is turned Off, the above screen appears. This is normal, and does not indicate trouble. If connected SDR or host computer is turned On again or cable is connected again, the previous screen is restored.

28. CHECKS AND ADJUSTMENTS

An SCT is a precision instrument that requires fine adjustments. It must be inspected and adjusted before use so that it always performs accurate measurements.

- Always perform checking and adjustment in the proper sequence beginning from “28.1 Plate Level” to “28.7 Additive Distance Constant”.
- In addition, the instrument should be inspected with special care after it has been stored a long time, transported, or when it may have been damaged by a strong shock.
- Make sure the instrument is securely set up and stable before performing checks and adjustments.

28.1 Plate Level

The bubble tube is made of glass, so it is sensitive to temperature changes or to shock. Check and adjust it as outlined below.

►PROCEDURE Checking and adjusting

1. Level the instrument and check the position of the bubble of the plate level.
☞ “7.2 Levelling”, steps 3 to 5.
2. Turn the upper part through 180° and check the bubble position. If the bubble is still centered, no adjustment is necessary. If the bubble is off-center, adjust as follows.
3. Correct half of the bubble displacement using levelling foot screw C.

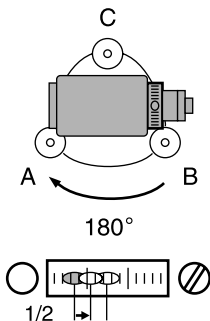

28. CHECKS AND ADJUSTMENTS

- Correct the remaining half of the displacement by using the adjustment pin to rotate the plate level adjustment screw. When the plate level adjustment screw is turned in the counterclockwise direction, the bubble moves in the same direction.
- Rotate the top of the instrument and continue adjustments until the bubble remains centered for any position of the upper part. If the bubble does not move to the center even when the adjustment has been repeated, ask your Sokkia agent to adjust it.

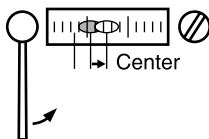

28.2 Circular Level

►PROCEDURE Checking and adjusting

- Perform the plate level inspection and adjustment or carefully use the plate level to level the instrument.
 "7.2 Levelling", steps 1 to 2.
- Check the position of the bubble of the circular level. If the bubble is not off-center, no adjustment is necessary. If the bubble is off-center, perform the following adjustment.

3. First confirm the off-center direction.
Use the adjusting pin to loosen the circular level adjustment screw on the side opposite to the direction the bubble is displaced to move the bubble to the center.

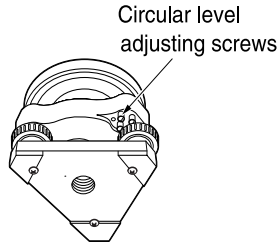

4. Adjust the adjusting screws until the tightening tension of the three screws is the same to align the bubble in the middle of the circle.



- Be careful that the tightening tension is identical for all the adjusting screws.
- Also, do not over-tighten the adjusting screws as this may damage the circular level.

28.3 Tilt Sensor

If the tilt angle shown on the display shifts from tilt angle 0° (zero point), the instrument is not correctly levelled. This will adversely affect angle measurement. Perform the following procedure to cancel the tilt zero point error.

► PROCEDURE Check

1. Carefully level the instrument. If necessary, repeat the procedures to check and adjust the bubble levels.
2. Press **[SET 0 ANG]** twice in the first page of the Meas mode screen to set the horizontal angle to 0° .

28. CHECKS AND ADJUSTMENTS

3. Select "Fld Adj. Settings" in the SETTINGS mode screen to display the current correction constant in the X (horizontal) direction and Y (vertical) direction.

```
Instr. const  
Tilt X 400 Y 400  
Collimation
```

Select "Level X Y" press {←} to display the tilt angle in the X (sighting) direction and Y (horizontal axis) direction.

```
Level Offset  
X -0° 01' 23"  
Y 0° 00' 04"  
HAR 184° 14' 50"  
Take F1 Shot  
OK
```

4. Wait a few seconds for the display to stabilize, then read the automatically compensated angles X1 and Y1.
5. Rotate the top of the instrument through 180°. Loosen the horizontal clamp and turn the instrument 180° while referring to the displayed horizontal angle, then retighten the clamp.
6. Wait a few seconds for the display to stabilize, then read the automatically compensated angles X2 and Y2.
7. In this state, calculate the following offset values (tilt zero point error).
 $X_{\text{offset}} = (X1+X2)/2$
 $Y_{\text{offset}} = (Y1+Y2)/2$

If one of the offset values (X_{offset} , Y_{offset}) exceeds $\pm 20''$, adjust the value using the following procedure.

When the offset value falls within the range $\pm 20''$, adjustment is not necessary.

Press {ESC} to return to <Fld Adj. Settings>.

►PROCEDURE Adjustment

8. Store values X2 and Y2
Press **[OK]** to set the horizontal angle to 0°. "Take F2 Shot" is displayed.
9. Rotate the top of the instrument through 180° until the displayed horizontal angle is 180° ±1' and **[OK]** is displayed.
10. Wait a few seconds for the display to stabilize, then store the automatically compensated angles X1 and Y1.
Press **[YES]** to store tilt angles X1 and Y1. The new correction constant is displayed.
11. Confirm that the values are in the adjustment range.
If both correction constant are within the range 400±120, select **[YES]** to renew the correction angle. <Fld Adj. Settings> is restored. Continue to step 12.
If the values exceed the adjustment range, select **[NO]** to cancel the adjustment and restore <Fld Adj. Settings>. Contact your Sokkia agent to perform the adjustment.

Level Offset		
Current	X400	Y400
New	X408	Y396
		NO YES

►PROCEDURE Recheck

12. Press {←} at <Fld Adj. Settings>.
13. Wait a few seconds for the display to stabilize, then read the automatically compensated angles X3 and Y3.
14. Rotate the top of the instrument through 180°.
15. Wait a few seconds for the display to stabilize, then read the automatically compensated angles X4 and Y4.
16. In this state, the following offset values (tilt zero point error) are calculated.
 $X_{\text{offset}} = (X3+X4)/2$
 $Y_{\text{offset}} = (Y3+Y4)/2$
When both offset values fall within the range $\pm 20''$, adjustment is completed.
Press {ESC} to return to <Fld Adj. Settings>.

If one of the offset values (X_{offset} , Y_{offset}) exceeds $\pm 20''$, repeat the check and adjustment procedures from the beginning. If the difference continues to exceed $\pm 20''$ after repeating the check 2 or 3 times, have your Sokkia agent perform the adjustment.

28.4 Collimation

With this option you can measure collimation error in your instrument so that the SCT can correct subsequent single face observations. To measure the error, make angular observations using both faces.

► Procedure

1. Select "Fld Adj. Settings" in the SETTINGS mode screen and select "Collimation".
2. Sight the reference point in Face 1.
Sight the reference point in Face 1 and press **[OK]**.
3. Sight the reference point in Face 2.
Rotate the instrument 180°. Sight the same point in Face 2 and press **[OK]**.
4. Set the constant.
Press **[YES]** to set the constant.
 - Press **[NO]** to discard the data and return to <Collimation>.

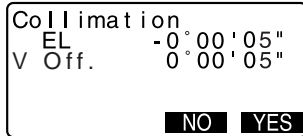

28.5 Reticle

► PROCEDURE Check 1: Perpendicularity of the reticle to the horizontal axis

- Carefully level the instrument.
- Align a clearly visible target (the edge of a roof for example) on point A of the reticle line.

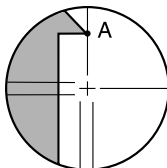

- Use the telescope fine motion screw to align the target to point B on a vertical line.

If the target moves parallel to the vertical line, adjustment is unnecessary. If its movement deviates from the vertical line, have your Sokkia service representative adjust it.

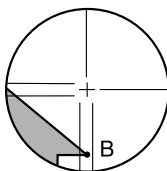

► PROCEDURE Check 2: Vertical and horizontal reticle line positions



- Perform the check procedure under slightly hazy and weakly scintillating conditions.

- Install a target at a point about 100m in the horizontal direction from the SCT.
- Level the instrument carefully, turn on the instrument's power.



3. While the Meas mode screen is displayed and the telescope is in face left, sight the center of the target and read out the horizontal angle A1 and the vertical angle B1.

Example: Horizontal angle $A1=18^{\circ} 34' 00''$

Vertical angle $B1=90^{\circ} 30' 20''$

4. While the telescope is in face right, sight the center of the target and read out the horizontal angle A2 and the vertical angle B2.

Example: Horizontal angle $A2=198^{\circ} 34' 20''$

Vertical angle $B2=269^{\circ} 30' 00''$

5. Do the calculations:

$A2-A1$ and $B2+B1$

If $A2-A1$ is within $180^{\circ}\pm 20''$ and $B2$ ($B1$ is within $360^{\circ}\pm 40''$), adjustment is unnecessary.

Example: $A2-A1$ (Horizontal angle)

$=198^{\circ} 34' 20'' - 18^{\circ} 34' 00''$

$=180^{\circ} 00' 20''$

$B2+B1$ (Vertical angle)

$=269^{\circ} 30' 00'' + 90^{\circ} 30' 20''$

$=360^{\circ} 00' 20''$

If the difference is large even after repeating the check 2 or 3 times, have your Sokkia service representative perform the adjustment.

28.6 Optical plummet

►PROCEDURE Checking

1. Carefully level the SCT and center a surveying point precisely in the reticle of the optical plummet.

28. CHECKS AND ADJUSTMENTS

- Turn the upper part through 180° and check the position of the surveying point in the reticle. If the surveying point is still centered, no adjustment is necessary. If the surveying point is no longer centered in the optical plummet, perform the following adjustment.

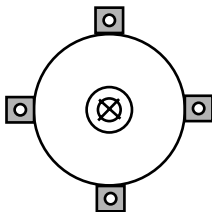

►PROCEDURE Adjustment

- Correct half the deviation with the levelling foot screw.

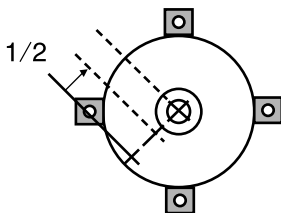

- Remove the optical plummet reticle cover.
- Use the 4 adjusting screws of the optical plummet to adjust the remaining half of the deviation as shown below.

When the surveying point is on the lower (upper) part of the illustration:

Loosen the upper (lower) adjusting screw slightly, and tighten the upper (lower) adjusting screw the same amount to move the surveying point to a point directly under the center of the optical plummet.

(It will move to the line in the figure on the right.)

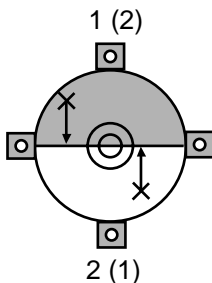

If the surveying point is on the solid line (dotted line):

Loosen the right (left) adjusting screw slightly and, tighten the left (right) adjusting screw by the same amount to move the surveying point to a point in the center of the optical plummet.

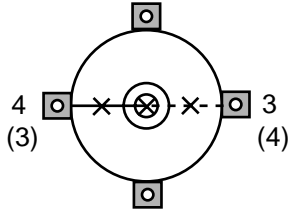

- Be extremely careful to adjust all the adjustment screws by the same amount so that none will be over-tightened.

6. Check to make sure that the surveying point remains centered on the reticle even if the upper part of the instrument is rotated. If necessary, perform the adjustment again.

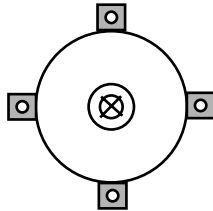

7. Replace the optical plummet reticle cover.

28.7 Additive Distance Constant

The additive distance constant K of the SCT is adjusted to 0 before delivery. Although it almost never deviates, use a baseline with a known distance precision to check that the additive distance constant K is close to 0 several times a year and whenever the values measured by the instrument begin to deviate by a consistent amount. Perform these checks as follows.



- Errors in setting up the instrument and reflective prism or in sighting the target will influence the additive distance constant. Be extremely careful to prevent such errors when performing these procedures.
- Set up so that the instrument height and the rod height are identical. If a flat place is not available, use an automatic level to make sure the heights are identical.

►PROCEDURE Check

- Find an area of flat ground where two points 100m apart can be selected.
Set up the Instrument at point A and the reflective prism at point B.
Establish a point C half way between points A and B.

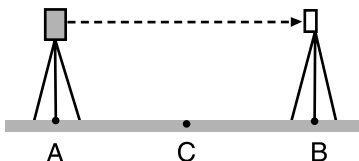

- Precisely measure the horizontal distance between point A and point B 10 times and calculate the average value.
- Place the SCT at point C directly between points A and B and set up the reflective prism at point A.

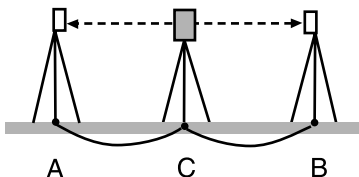

- Precisely measure the horizontal distances CA and CB 10 times each and calculate the average value for each distance.
- Calculate the additive distance constant K as follows.
$$K = AB - (CA+CB)$$
- Repeat steps 1 to 5 two or three times.
If the additive distance constant K is within $\pm 3\text{mm}$ even once, adjustment is unnecessary.
If it always exceeds this range, have your Sokkia service representative perform an adjustment.

29. STANDARD EQUIPMENT AND OPTIONAL ACCESSORIES

29.1 Standard Equipment

- Please verify that all equipment is included.

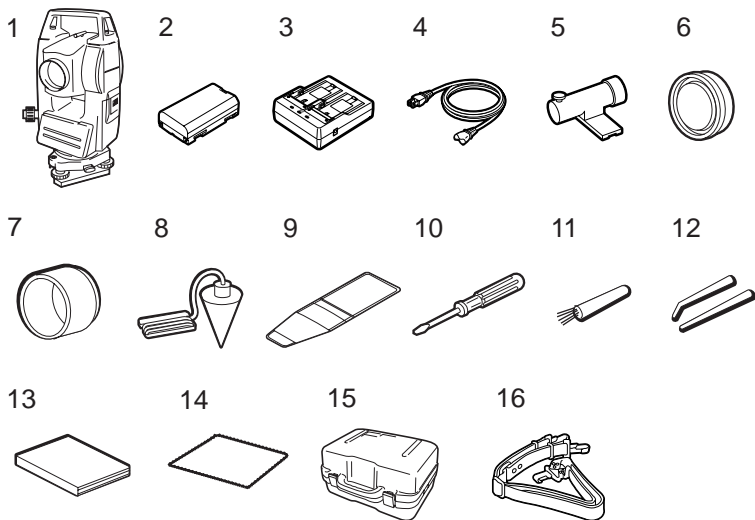

1	SCT main unit	1	9	Tool pouch	1
2	Battery (BDC46B)	1	10	Screwdriver	1
3	Battery charger (CDC68)	1	11	Lens brush	1
4	Power cable (EDC113B)	1	12	Adjusting pin	2
5	Tubular compass (CP7)	1	13	Operator's manual	1
6	Lens cap	1	14	Cleaning cloth	1
7	Lens hood	1	15	Carrying case (SC196)	1
8	Plumb bob	1	16	Carrying strap	1

29. STANDARD EQUIPMENT AND OPTIONAL ACCESSORIES

● Tubular compass (CP7)

Slide the tubular compass into the tubular compass slot, loosen the clamp screw, then rotate the top part of the instrument until the compass needle bisects the index lines. The telescope's face left sighting direction in this position will indicate magnetic north. After use, tighten the clamp and remove the compass from the slot.

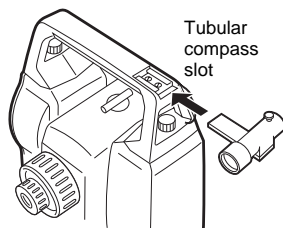

- The tubular compass is susceptible to the influence of nearby magnets or metal. Such influence could cause it to fail to accurately indicate magnetic north. Do not use magnetic north as indicated by this compass for base line surveying.

● Plumb bob

The plumb bob can be used to set up and center the instrument on days when there is little wind. To use the plumb bob, unwind its cord, pass it through the cord grip piece as shown in the figure to adjust its length, then suspend it from the hook attached to the centering screw.

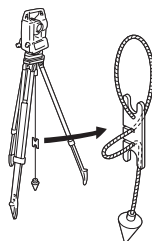

● Handle

The carrying handle can be removed from the instrument. To remove it, loosen the handle securing screw

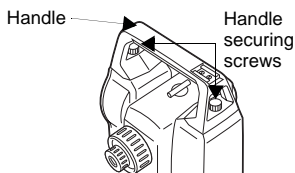

29.2 Optional Accessories

The following are optional accessories which are sold separately from the SCT.
 ☞ Target and power supply optional accessories: "29.3 Target System", and "29.4 Power Supply System".

● Telescope eyepiece lens (EL6)

Magnification: 30X

● Diagonal eyepiece (DE25)

The diagonal eyepiece is convenient for observations near the nadir and in narrow spaces.

Magnification: 30X

After removing the handle from the SCT, loosen the attachment screw to remove the telescope eyepiece. Then screw the diagonal lens into place.

☞ Handle removal method:
 "29.1 Standard Equipment"

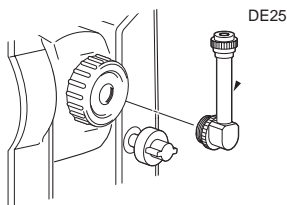

● Solar filter (OF3A)

When sighting targets where glare is present, solar observations for example, attach it to the objective lens of the SCT to protect its interior and the eyes of its operator. The filter part can be flipped up without being removed.

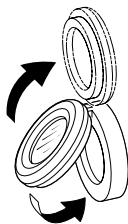

● Printer cable (DOC46)

The SCT can be connected to a Centronics specification printer which supports ESC/PTM by the printer cable DOC46. This allows direct output of data from the SCT to a printer.



29. STANDARD EQUIPMENT AND OPTIONAL ACCESSORIES

● **Battery Unit (BDC55)**

BDC55 is used as the power source for the ACE5 and LAP1.

● **Auto-collimation eyepiece (ACE5)**

The ACE5 is designed to detect a slight shift in inclination of the reflector. The BDC55 is the power source for the ACE5. The buttons on the BDC55 can also be used to operate the ACE5. For details, see the ACE5 Operator's manual.

● **Laser Plummet (LAP1)**

When using the LAP1, a laser is emitted from the bottom of the main unit making it easier to position the instrument over the surveying point. The Battery Unit (BDC55) is the power source for the LAP1. The buttons on the BDC55 can also be used to operate the LAP1. For details, see the LAP1 Operator's manual.

● **Power cable for LAP1 (EDC109)**

● **Interface cable**

Connect between the SCT and the host computer for data output.

Computer	Cable	Notes
IBM PC/AT or compatible	DOC26	Length: 2m Pin Numbers and signal levels: RS-232C compatible D-sub connector: DOC26: 25 pins (female) DOC27: 9 pins (female)
	DOC 27	
Other computers	DOC1	No connector for attachment to a computer.

29.3 Target System

- Because all Sokkia reflecting prisms and accessories have standardized screws, it is possible to combine these prisms, accessories, etc. according to your objectives.
- The following are all special accessories (sold separately).
- Because these targets (*2) are coated with fluorescent paint, they reflect when there is little light.



- When using a reflecting prism equipped with a target for distance and angle measurements, be sure to direct the reflective prism correctly and sight the center of the prism target accurately.
- Each reflective prism (*1) has its own prism constant value. When changing prisms, be sure to change the prism constant correction value.
- To use the triple prism assembly AP31 or AP32 as a single prism for short distance measurements, mount the single reflective prism AP01AR in the center mounting hole of the prism holder.

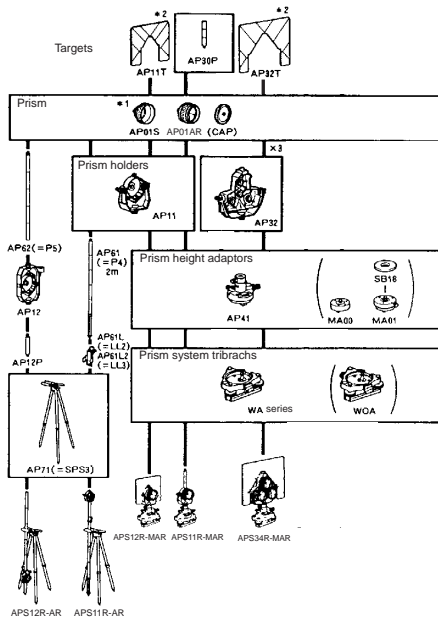

● 2-point target (2RT500-K)

This target is used for two-distance offset measurement.

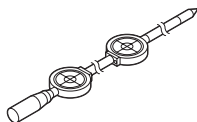

- For information about reflective sheet targets and target devices, contact your Sokkia agent.

● Instrument height adaptor (AP41)

Adjust the level of the AP41 instrument height adaptor following the checking and adjustment methods of plate level.

"28.1 Plate Level"

Adjust the optical plummet of the AP41 instrument height adaptor following the checking and adjustment methods of optical plummet.

"28.6 Optical plummet"

The height of the AP41 instrument height adaptor can be adjusted using two fixing screws. Make sure that the instrument height "236" (mm) is displayed in the instrument height adjustment window.

Loosen the screws ① and rotate it counterclockwise ②.

Move the part ③ up or down until the desired instrument height is displayed in the adjustment window ④, then rotate it clockwise and tighten the screws ⑤.

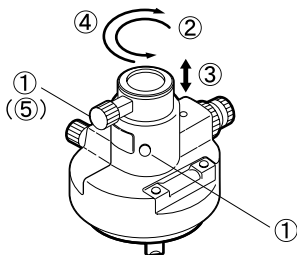

● Adjusting plate (WA Series)

Adjust the circular level of the adjusting plate for a prism following the checking and adjustment methods of circular level.

"28.2 Circular Level"

29.4 Power Supply System

Operate your SCT with the following combinations of power equipment.



- Be sure to carefully read the operating manuals for the battery and charger before operating them.
- Never use any combination other than those indicated below. If you do, the SCT could be damaged.

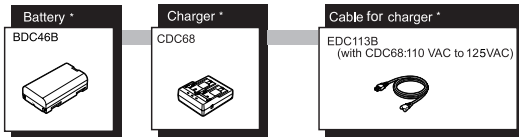

30. SPECIFICATIONS

Telescope

Length:	170 mm
Aperture:	45 mm (EDM: 48 mm)
Magnification:	26X
Image:	Erect
Resolving power:	3.5"
Field of view:	1° 30'
Minimum focus:	1.0 m
Focussing screw:	1 speed
Reticle illumination:	5 brightness levels

Angle measurement

Horizontal and Vertical circles type:	Rotary absolute encoder
Angle units:	Degree/Gon/Mil (selectable)
Minimum display:	1" (0.0002gon/0.005mil)/5" (0.001gon/0.02mil) (selectable)
Accuracy:	6" (0.0019gon) (0.025mil) (ISO 17123-3 :2001)
Measuring time:	Less than 0.5 sec
Automatic compensator:	ON (V & H/V)/OFF (selectable)
Type:	Liquid 2-axis tilt sensor
Minimum display:	Agrees with minimum displayed measurement angle
Range of compensation:	±3'
Collimation compensation:	On/Off (selectable)
Measuring mode:	
Horizontal angle:	Right/Left (selectable)
Vertical angle:	Zenith/Horizontal 0°/Horizontal ±90°/% (selectable)

Distance Measurement

Measuring range:	(Using Sokkia's reflective prism/reflective sheet target during normal atmospheric conditions *1/ *2 is good atmospheric conditions) (Slight haze, visibility about 20 km, sunny periods, weak scintillation) Reflective sheet RS90N-K*3: 2.0 to 120 m/390ft Reflective sheet RS50N-K*3: 2.0 to 50 m/160ft Reflective sheet RS10N-K*3: 2.0 to 20 m/70ft Compact prism CP01: 1.0 to 800 m/2,620ft Standard prism AP01AR X 1: 1.0 to 2,400 m/ 7,870ft 1.0 to 2,700 m (8,850ft)*2 Standard prism AP01AR X 3: 1.0 to 3,100 m/ 10,160ft
------------------	---

30. SPECIFICATIONS

	to 3,500 m (11,480ft)*2
	Mini pole prism OR1PA: 1.0 to 500 m/1,640ft
Minimum display:	
	Fine measurement, Rapid measurement: 0.001 m/0.01ft/ 1/8 in./ 1/16 in. (only when using inch units)
	Tracking measurement: 0.01 m/0.1ft/ 1/2 in.
Maximum slope distance:	4199.999 m/13779.52ft
Distance unit:	m/ft/US ft/inch (selectable) (Int. ft or US ft settings are available when using feet or inch units)
Accuracy:	
(Using prism)	Fine measurement: $\pm(2 + 2 \text{ ppm} \times D)$ mm Rapid measurement: $\pm(5 + 5 \text{ ppm} \times D)$ mm
(Using reflective sheet target)	Fine measurement: $(4 + 3 \text{ ppm} \times D)$ mm Rapid measurement: $(5 + 5 \text{ ppm} \times D)$ mm
	(D: measurement distance; Unit: mm)
Measurement mode:	Fine measurement (single/repeat/average)/ Rapid measurement (single/repeat)/Tracking (selectable)
Measuring time:	
	Fine measurement: 2.8 sec. (2.4 sec.) + every 1.6 sec.
	Rapid measurement: 2.3 sec. (1.9 sec.) + every 0.8 sec.
	Tracking measurement: 1.8 sec. (1.4 sec.) + every 0.3 sec.
	*() : When EDM standby is set to ON
Signal source:	Infrared LED (Class 1 IEC 60825-1: 2001-1)
Atmospheric correction:	
	Temperature input range: - 30 to 60°C (in 1°C step)/- 22 to 140°F (in 1°F step)
	Pressure input range: 500 to 1,400 hPa (in 1hPa step) 375 to 1,050 mmHg (in 1mmHg step) 14.8 to 41.3 inchHg (in 0.1inchHg step)
	ppm input range: -499 to 499 ppm (in 1 ppm step)
Prism constant correction:	-99 to 99 mm (in 1 mm step)
Earth curvature and refraction correction:	No/Yes K=0.142/Yes K=0.20 (selectable)
Sea level correction:	No/Yes (selectable)

*1: Slight haze, visibility about 20 km, sunny periods, weak scintillation.

*2: No haze, visibility about 40 km, overcast, no scintillation.

*3: Figures when the laser beam strikes within 30° of the reflective sheet target.

30. SPECIFICATIONS

Bluetooth wireless technology

BT Qualification ID	B02706
Transmission method:	FHSS (<i>Bluetooth</i> Specification Ver.1.2 compatible)
Modulation:	GFSK (Gaussian-filtered frequency shift keying)
Frequency band:	2.4 to 2.4835GHz
<i>Bluetooth</i> profile	SPP, GAP
Power class	Class 2
Usable range	about 2m (usable range may vary with different operating conditions)
Authentication:	Yes/No

Power Supply

Power source:	Rechargeable Li-ion battery BDC46B
Battery state indicator:	4 levels
Working duration at 25°C:	
Distance & angle measurement:	about 8 hours (Fine single measurement = every 30 sec.)
Angle measurement only:	about 13.5 hours
Charging time at 25°C:	about 2.5 hours (using CDC68)
BDC46B	Nominal voltage: 7.2V
CDC68	Storage temperature range: -20 to 35°C
	Input voltage:
	with EDC113B:110 to 125 VAC 50/60Hz
	Charging temperature range:0 to 40°C
	Storage temperature range: -20 to 65°C

General

Display:	LCD graphic display, 192 dots X 80 dots 1 LCD graphic display with illuminator
Operation panel (keyboard):	15 keys (soft function, operations, power on, light)
Auto power-off:	5 levels (selectable)
Internal memory:	about 10000 points
Data output:	Asynchronous serial, RS232C compatible Centronics compatible (with DOC46) Printer with ESC/PTM mode (emulation function)
Sensitivity of levels:	
Plate level:	40"/2 mm
Circular level:	10"/2 mm

Optical plummet:

Image: Erect

Magnification: 3X

Minimum focus: 0.3 m

Horizontal and vertical motion screw: 1 level

Operating temperature: -20 to 50°C

Storage temperature range: -30 to 70°C

Dust and water resistance: IP66 (IEC 60529: 2001)

Instrument height: 236 mm from tribrach bottom

193 mm from tribrach dish

Size (with handle): 165 (W) X 170 (D) X 341 (H) mm

Weight (with handle and battery): 5.1 kg (11.3lb)

31. EXPLANATION

31.1 Manually Indexing the Vertical Circle by Face Left, Face Right Measurement

The 0 index of the vertical circle of your SCT is almost 100% accurate, but when it is necessary to perform particularly high precision angle measurements, you can eliminate any inaccuracy of the 0 index as follows.



- If the power is cut off, the vertical circle indexing is ineffective. Do it again every time the power is turned on.

►PROCEDURE Manually indexing the vertical circle

1. Select "Shot Settings" in <Config>. Set "V manual" (vertical circle indexing method) to "Yes."

2. Go to the Meas mode screen. The vertical angle V1 is displayed under "Take F1 Shot"

```
Set H Ang. to 0
                Take F1 Shot
ZA              V1
HAR             0°00'00"
                OK
```

3. Carefully level the instrument.

4. Accurately sight a clear target with a distance of about 30m in the horizontal direction with the telescope in face left.

Press **[OK]**. The vertical angle V2 is displayed under "Take F2 Shot"

```
Set H Ang. to 0
                Take F2 Shot
ZA              V2
HAR             0°00'00"
                OK
```

5. Turn the upper part through 180° and clamp it. Then set the telescope in the face right position and accurately sight the same target.

Press **[OK]**.

The vertical and horizontal angles are displayed.

This concludes the vertical circle indexing procedure.

32. REGULATIONS

Users must ensure that their instrument is compliant with the relevant regulations and legal restrictions in place in the country of use.

For users in the US

WARNING: Changes or modifications to this unit not expressly approved by the party responsible for compliance could void the user's authority to operate the equipment.

NOTE: This equipment has been tested and found to comply with the limits for a Class A digital device pursuant to Part 15 of the FCC Rules and RSS-210 of the IC Rules. These limits are designed to provide reasonable protection against harmful interference when the equipment is operated in a commercial environment. This equipment generates, uses, and can radiate radio frequency energy and, if not installed and used in accordance with the instruction manual, may cause harmful interference to radio communications. Operation of this equipment in a residential area is likely to cause harmful interference in which case the user will be required to correct the interference at his own expense.

This transmitter must not be co-located or operated in conjunction with any other antenna or transmitter.

This equipment complies with FCC radiation exposure limits set forth for uncontrolled equipment and meets the FCC radio frequency (RF) Exposure Guidelines in Supplement C to OET65. This equipment has very low levels of RF energy that is deemed to comply without maximum permissive exposure evaluation (MPE). But it is desirable that it should be installed and operated with at least 20cm and more between the radiator and person's body (excluding extremities: hands, wrists, feet and ankles).

For users in Canada

This Class A digital apparatus meets all requirements of Canadian Interference-Causing Equipment Regulations.

Cet appareil numérique de la Class A respecte toutes les exigences du Règlement sur le matériel brouilleur du Canada.

This class A digital apparatus complies with Canadian ICES-003.

Cet appareil numérique de la classe A est conforme à la norme NMB-003 du Canada.

Operation is subject to the following two conditions: (1) this device may not cause interference, and (2) this device must accept any interference, including interference that may cause undesired operation of this device.

32. REGULATIONS

This equipment complies with IC radiation exposure limits set forth for uncontrolled equipment and meets RSS-210 of the IC radio frequency (RF) Exposure rules. This equipment has very low levels of RF energy that is deemed to comply without maximum permissive exposure evaluation (MPE). But it is desirable that it should be installed and operated with at least 20cm and more between the radiator and person's body (excluding extremities: hands, wrists, feet and ankles).

SOKKIA CO.,LTD.

<http://www.sokkia.co.jp/english/>

260-63, HASE, ATSUGI, KANAGAWA, 243-0036 JAPAN
PHONE +81-46-248-7984 FAX +81-46-247-1731

2nd ed. 03-0709 Printed in China

©2006 SOKKIA CO., LTD.